

How to put your model together / Mode d'assemblage de votre modèle.  
 Anweisungen für den Zusammenbau des Modells / Methode voor het  
 in elkaar zetten van Uw model / Så här sätter Du ihop modellen / Per  
 montare il vostro modello / Näin kootaan malli.

Symbols used in assembly diagrams / Symboles employés sur les diagrammes d'assemblage.  
 In den Zusammenstellungsskizzen verwendete Zeichen / Tekens die in de monteringsdiagrammen  
 gebruikt worden / Teckenförklaring till sammanfogningsdiagram / Simboli usati nello  
 schema de montaggio / Asennuskuvioissa käytettyjen merkkien selitykset.



Cement parts together.  
 Coller les pièces ensemble.  
 Teile zusammenkleben.  
 Cementeer de delen samen.  
 Limma ihop delarna.  
 Cementare le parti l'una con l'altra.  
 Osat liimataan yhteen.



Do not cement together.  
 Ne pas coller ensemble.  
 Nicht zusammenkleben.  
 Cementeer niet samen.  
 Limma inte ihop delarna.  
 Non cementare le parti.  
 Osia ei liimata yhteen.



Choice of parts provided.  
 Choix de pièces fournies.  
 Mitgelieferte Auswahl an Teilen.  
 Keuze van beschikbare onderdelen.  
 Dessa delar medföljer för valfri användning.  
 Particolari a scelta.  
 Osien käyttö valinnanvaraista.



Cut with a sharp knife.  
 Couper avec un couteau tranchant.  
 Mit einem scharfen messer schneiden.  
 Snijd met een scherp mes.  
 Skär med en skarp kniv.  
 Tagliare con un coltello ben affilato.  
 Leikatkaa terävällä veitsellä.



Shape with a hot knife.  
 Former au canif chaud.  
 Mit einem heißen Messer formen.  
 Vorm met een heet mes.  
 Forma med varm kniv.  
 Modellare con la lama di un coltello, riscaldata.  
 Muovattaa kuumalla veitsellä.

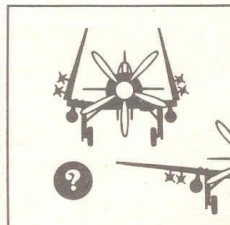
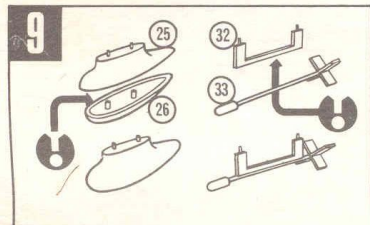
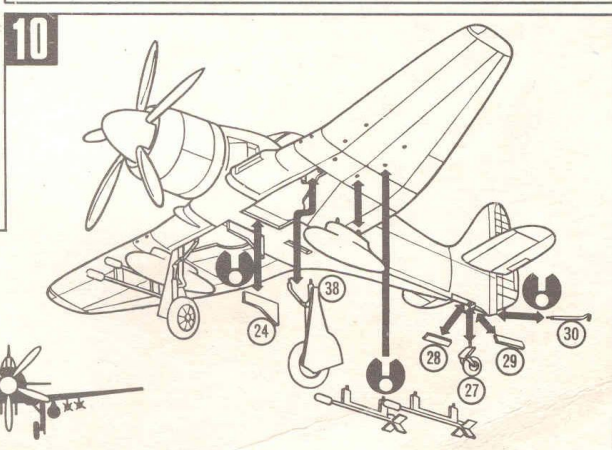
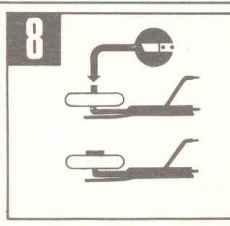
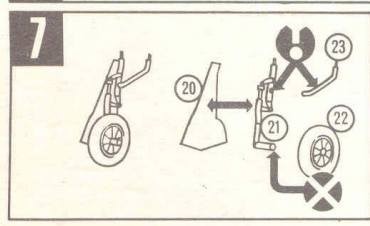
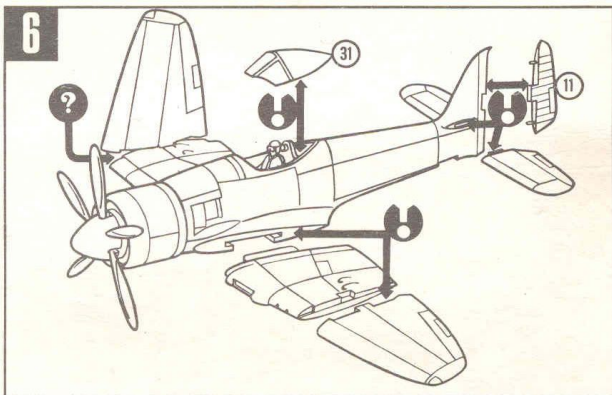
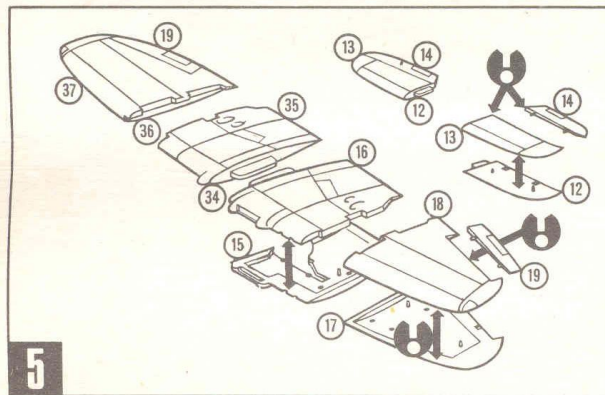
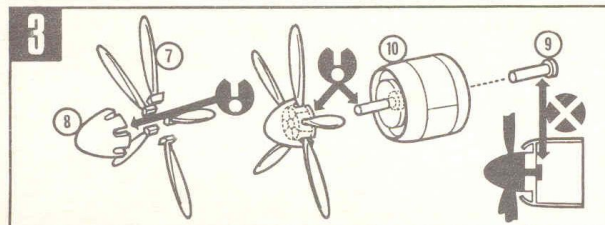
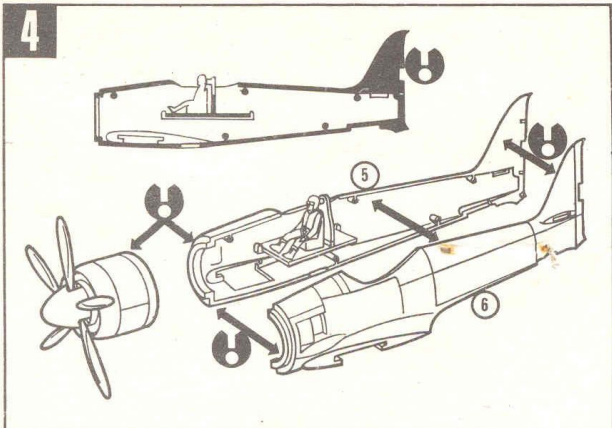
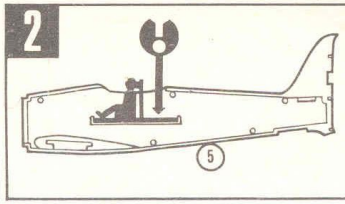
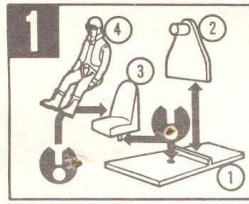

1:72  
international  
scale model  
assembly kit

HAWKER  
SEA FURY

FROG

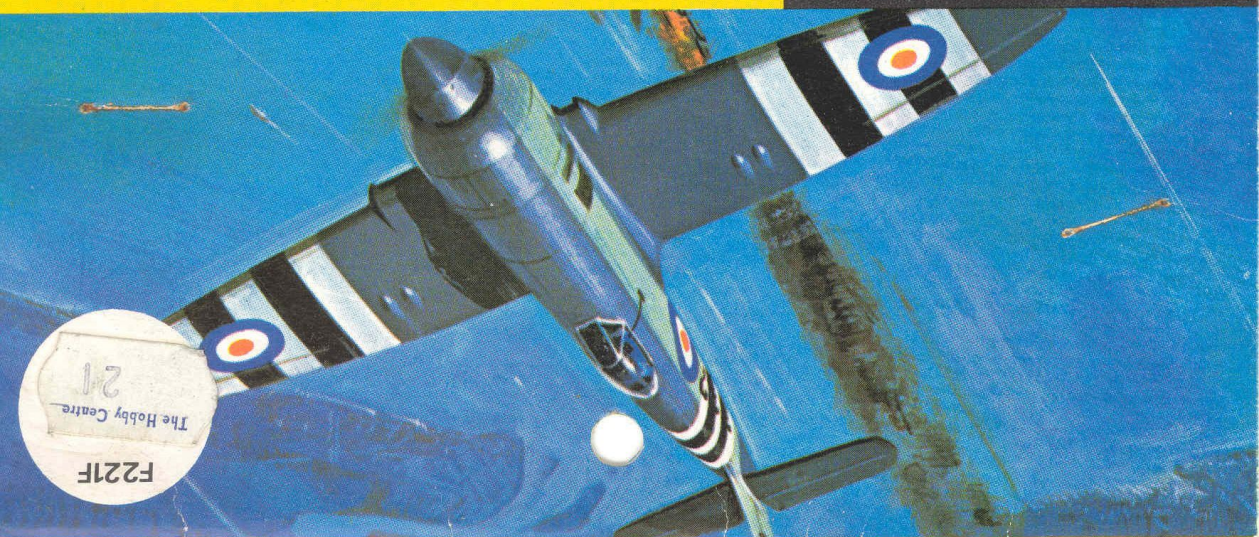

# Aircraft Colour Guide

## HAWKER SEA FURY

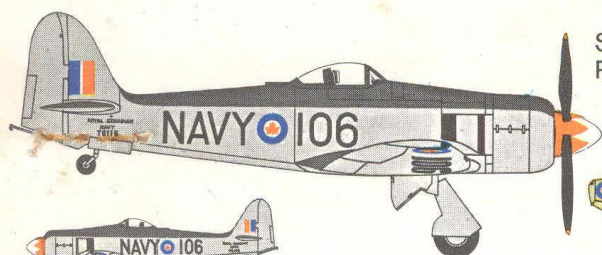

Squadron VF-870  
Royal Canadian Navy 1951

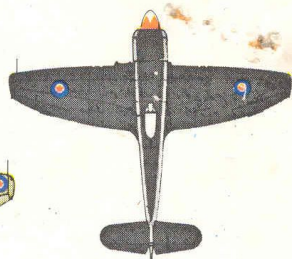

Lt. Peter Carmichael R.N.  
No. 802 Squadron, Fleet Air Arm  
H.M.S. Ocean, Korea, August 1952

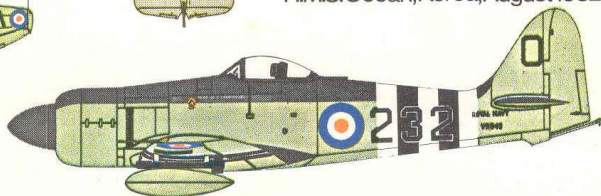
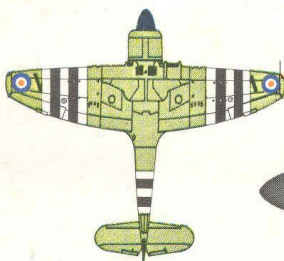
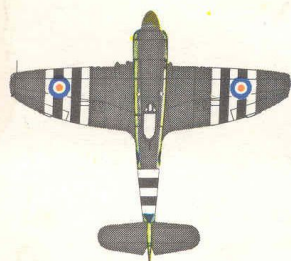
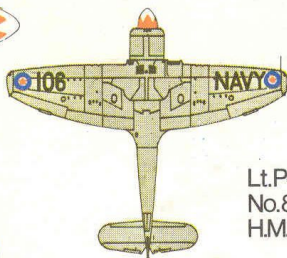

Made in Great Britain



Multi lingual assembly pictures! Choice of markings and parts for one of two different models.



Gemakkelijk te volgen Nederlandse instructies. Keuze uit merktekens voor twee verschillende modellen!



Übersichtliche deutsche Zusammenbauanleitung. Markierungswahl für zwei verschiedene Modelle!



Instructions faciles à suivre en Français. Choix de couleurs et pièces pour un des deux modèles!



Instruktioner på svenska. Markeringar för två olika modeller att välja mellan.



Suomenkieliset ohjeet. Kahdet valinnanvaraiset tunnuukset.



Istruzioni in Italiano facili da eseguire, decalcs e mascheramento a scelta!