

FROG[®]

McDONNELL PHANTOM

How to put your model together.
Mode d'assemblage de votre modèle.
Anweisungen für den Zusammenbau des Modells.
Methode voor het in elkaar zetten van Uw model.
Så här sätter Du ihop modellen.
Per montare il vostro modello.

Symbols used in assembly diagrams / Symboles employés sur les diagrammes d'assemblage / In den Zusammenstellungsskizzen verwendete Zeichen.
Tekens die in de monteringsdiagrammen gebruikt worden / Teckenförklaring till sammanfogningsdiagram / Simboli usati nello schema de montaggio.



Cement parts together.
Coller les pièces ensemble.
Teile zusammenkleben.
Cementeer de delen samen.
Limma ihop delarna.
Cementare le parti l'una con l'altra.



Do not cement together.
Ne pas coller ensemble.
Nicht zusammenkleben.
Cementeer niet samen.
Limma inte ihop delarna.
Non cementare le parti.



Shape with hot knife.
Former au canif chaud.
Mit einem heißen Messer formen.
Vorm met een heet mes.
Forma med varm kniv.
Modellare con la lama di un coltello, riscaldata.

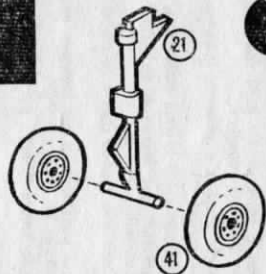
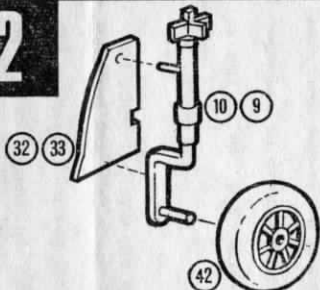
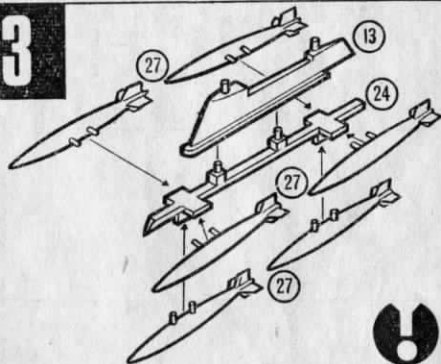
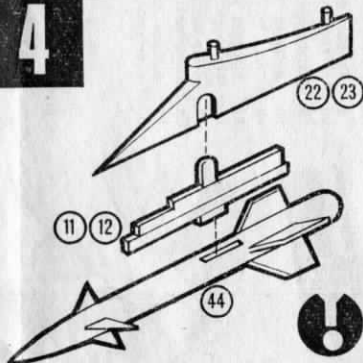

Choice of parts provided.
Choix de pièces fournies.
Mitgelieferte Auswahl an Teilen.
Keuze van beschikbare onderdelen.
Dessa delar medföljer för valfri användning.
Particolari a scelta.

1**2****3****4**

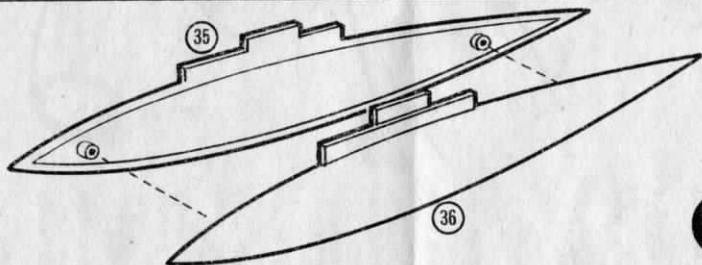
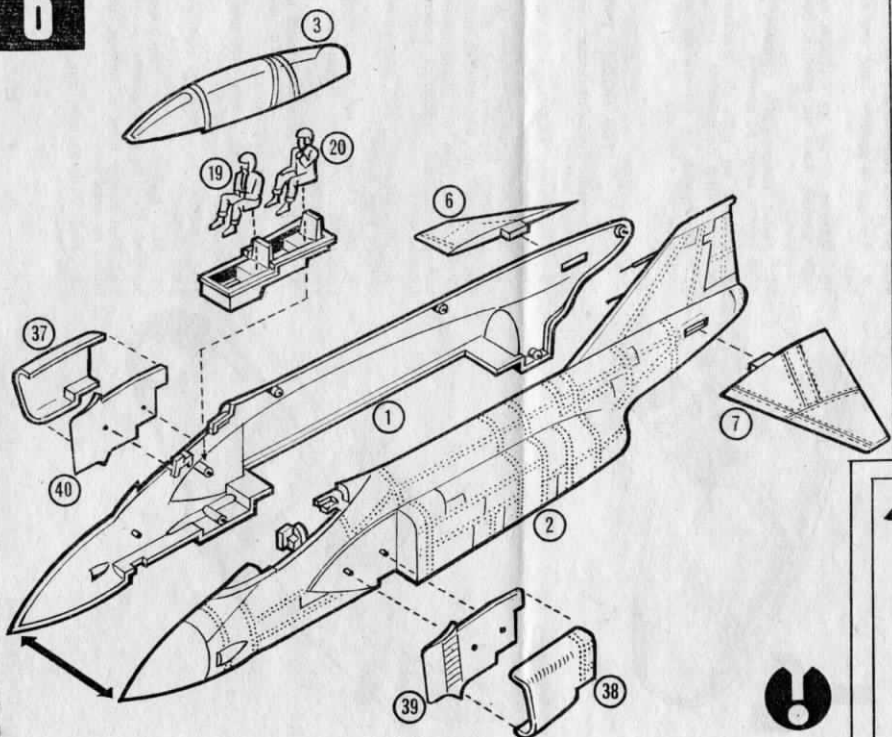
5**6**

7

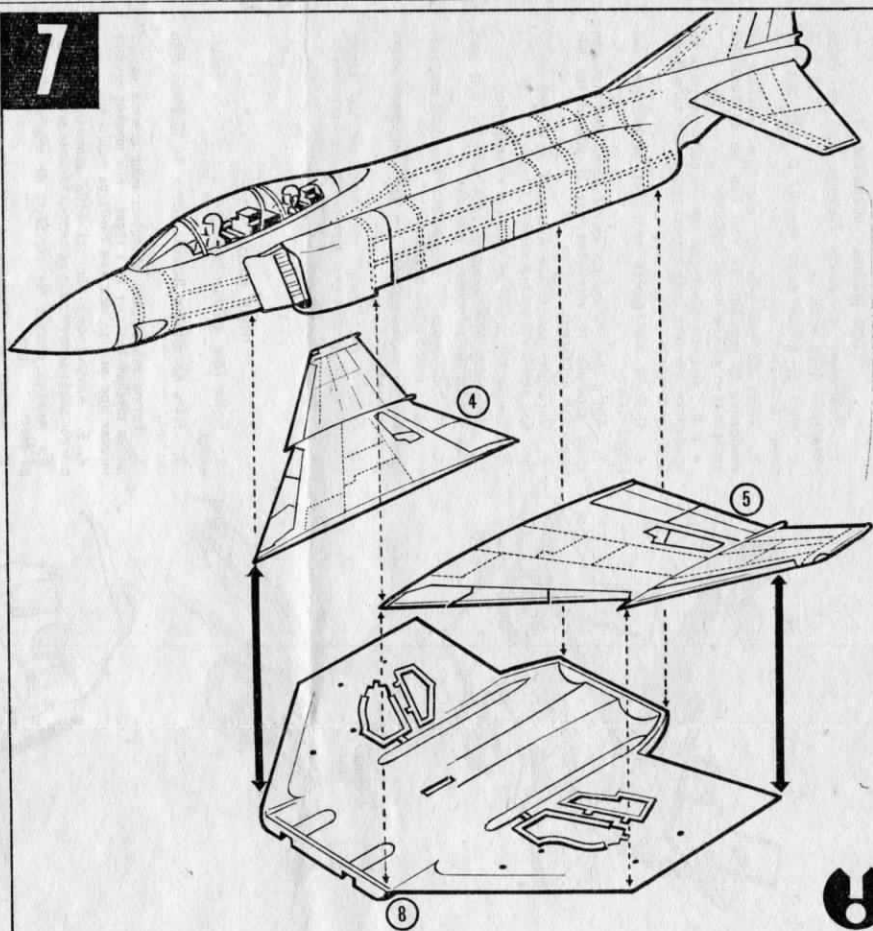

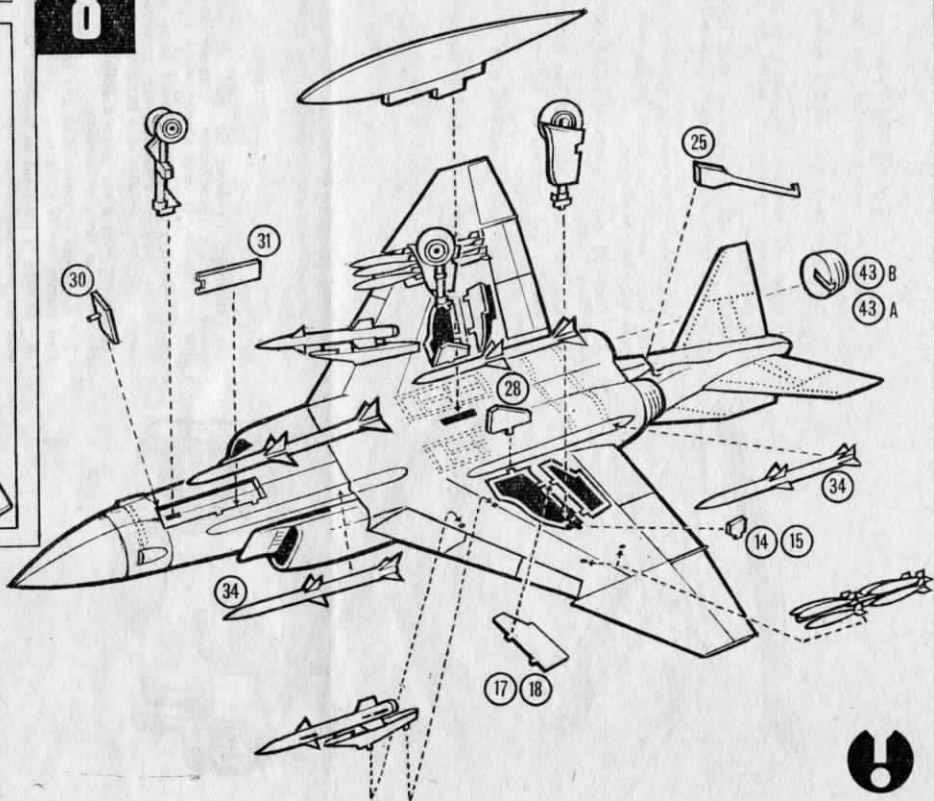

'TOP MODEL' TIPS.

1. Check the exact fit of the parts before cementing.
2. Paint the small parts before cutting from the stem.
3. Shape the cement tube nozzle to control the flow. Too much cement will soften the plastic and spoil your model.
- 4 & 5. Use adhesive tape to hold the parts together and carry on other operations whilst it sets hard.
6. Use eyebrow tweezers to position small pieces.
7. Apply cement to small pieces with a pin to avoid marking the surface.
8. Clean off excess plastic and DRY cement with a small sharp knife.
9. Rub down the model with fine emery paper.
10. Remove any scratches by rubbing with a cloth soaked in metal polish.
11. Mark the surface outline with a soft pencil before painting.
12. Cut the paint brush short to obtain a stippled effect.
13. Use the "Frog" working tray to hold your small pieces.

CONSEILS POUR LE MONTAGE DES 'TOP MODELS'.

1. Vérifiez bien que les parties vont ensemble avant de cimenter.
2. Peignez les petites parties avant de les couper de la tige.
3. Façonnez l'embout du tube de ciment pour mieux contrôler l'écoulement. Trop de ciment ramollira le plastique, et peut abîmer votre modèle.
- 4,5. Utilisez un ruban adhésif pour joindre les différentes parties ensemble, et occupez-vous des autres opérations pendant que la colle sèche.
6. Servez-vous d'une pince à épiler pour mettre en place les plus petits morceaux.
7. Appliquez le ciment avec une épingle pour éviter d'en mettre sur la surface.
8. Retirez le plastique et le ciment SEC en excédent avec un petit couteau aiguisé.
9. Frottez le modèle avec une toile émeri à grain fin.
10. Retirez toutes les éraflures en frottant avec un linge trempé dans du produit pour faire luire les métaux.
11. Faites ressortir les contours avec un crayon à mine tendre avant de peindre.
12. Coupez les poils du pinceau très courts pour obtenir un effet de pointillé.
13. Servez-vous du plateau de travail "Frog" pour conserver ensemble tous vos petits morceaux.

'TOP MODEL' TIPS.

1. Vor dem Zusammenkleben nachprüfen, ob die Teile genau passen.
2. Die kleinen Teile anmalen, bevor sie vom Halm abgeschnitten werden.
3. Die Tubenspitze so formen, dass die ausfließende Klebstoffmenge reguliert wird. Zu viel Klebstoff löst den Kunststoff auf und schadet dem Modell.
- 4 & 5. Die Teile mit Klebestreifen zusammenhalten und während des Trocknens andere Arbeiten durchführen.
6. Die kleinen Teile mit einer Pinzette in die richtige Lage bringen.
7. Den Klebstoff auf die kleinen Teile mit einer Stecknadel auftragen, damit die Oberfläche nicht verschmiert wird.
8. Allen abstehenden Kunststoff und überfließenden Klebstoff nach dem Trocknen mit einem kleinen, scharfen Messer entfernen.
9. Das Modell mit feinem Schmirgelpapier abschmirgeln.
10. Kratzer mit einem in Metallpolitur getauchten Tuch abreiben.
11. Die Konturen vor dem Anmalen mit einem weichen Bleistift aufzeichnen.
12. Den Pinsel kurz schneiden, um einen Punktier-effekt zu erhalten.
13. Den Frog-Karton zur Aufnahme der kleinen Teile benutzen.

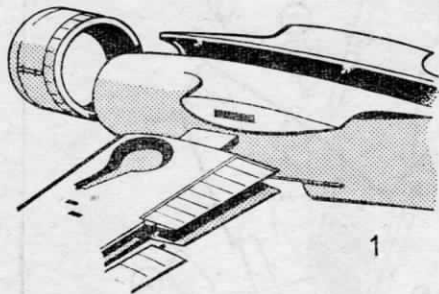

1

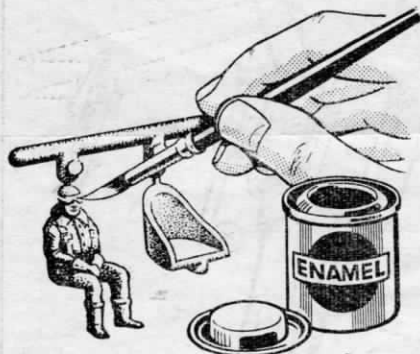

2

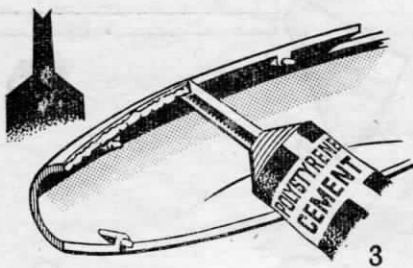

3

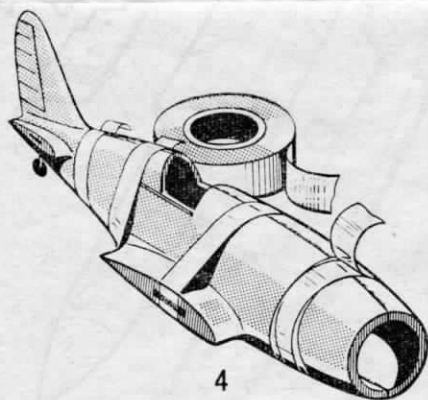

4

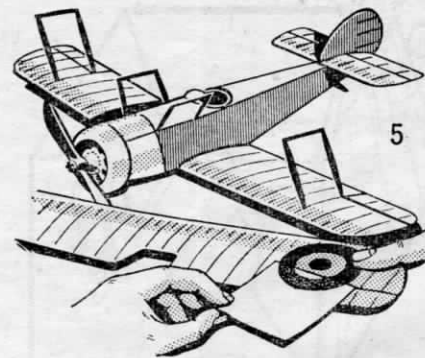

5

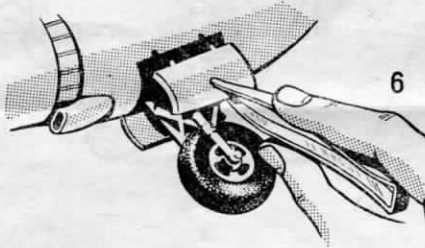

6

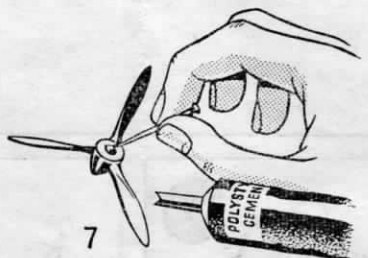

7

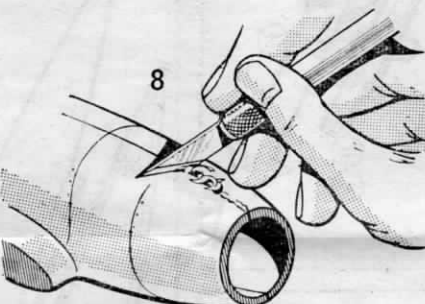

8

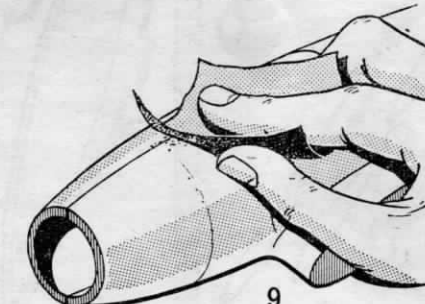

9

"TOP MODEL" WENKEN.

1. Controleer de juiste montage van de delen voordat U deze lijmt.
2. Verf de kleine delen voordat U deze van "de stam" afsnijdt.
3. Vorm de tuit van de tube lijm teneinde de uitvloeiing te regelen. Te veel lijm zal de kunststof zacht maken en Uw model bederven.
- 4 & 5. Gebruik kleefband om de delen tezamen te houden en verricht andere werkzaamheden terwijl de lijm hard wordt.
6. Gebruik een pincet voor het aanbrengen van kleine delen.
7. Breng de lijm op de kleine delen aan met een speld teneinde te vermijden dat U sporen op het oppervlak achterlaat.
8. Verwijder overtollige kunststof en opgedroogde lijm met een klein scherp mes.
9. Schuur het model af met fijn amarilpapier.
10. Verwijder alle krassen door wrijven met een doek die in metaalpolitoer geweekt is.
11. Merk de oppervlak omtrek met een zacht potlood voordat U met verven begint.
12. Snij de verfkwasst kort, om een gepunteerd effect te verkrijgen.
13. Gebruik het "Frog" werkbord om Uw kleine onderdelen in te bewaren tijdens de werkzaamheden.

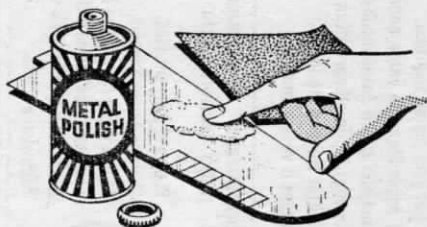

10

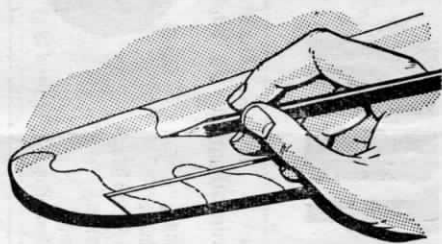

11

"TOP MODEL" TIPS.

1. Kolla före sammanfogningen att delarna passar exakt.
2. Måla de mindre delarna innan de lösgöres från skaften.
3. Forma munstycket på tuben med cement så att lagom mycket kommer ut i taget. För mycket cement mjukar upp plasten och kan fördärva modellen.
- 4, 5. Använd tejp för att hålla samman delarna, och gör något annat medan cementen hårdnar ordentligt.
6. Använd pincett för att sätta de mindre delarna på plats.
7. Använd en tandpetare el. likn. för att applicera cement på de mindre delarna för att undvika att skrapa ytan.
8. Ta bort överflödigt plast och TORR cement med en liten vass kniv.
9. Sandpappra modellen med fint sandpapper.
10. Avlägsna eventuella repor med metallpolish på en trasa.
11. Markera ytkonturerna med en mjuk blyertspenna före målningen.
12. Klipp borsten på penseln kort för att åstadkomma en punkteffekt.
13. Använd arbetsbrickan "Frog" för att hålla de mindre delarna.

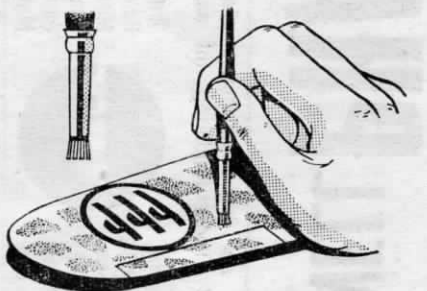

12

SUGGERIMENTI PER "IL MIGLIORE MODELLO".

1. Controllare l'inserimento delle varie parti prima di cementarle.
2. Dipingere le piccole parti prima di tagliarle dalla struttura comune.
3. Formare il becco del tubo di cemento per controllarne l'uscita. Troppo cemento ramollisce la plastica e rovina il modello.
- 4 & 5. Usare nastro adesivo per tenere insieme le parti e continuare con altre operazioni mentre il cemento si indurisce.
6. Usare pinze da sopraciglia per fissare in posizione le piccole parti.
7. Applicare il cemento sulle piccole parti con uno spillo per evitare di segnarne la superficie.
8. Pulire gli eccessi di plastica e cemento indurito con un piccolo coltello tagliente.
9. Sfregare il modello con carta vetrata molto fine.
10. Eliminare le graffiature per mezzo di un panno inbevuto di lucido da metalli.
11. Segnare i limiti con una matita tenera prima di dipingere.
12. Tagliare i peli del pennello corti per ottenere un effetto di punteggiatura.
13. Usare il vassoio da lavoro "Frog" per le piccole parti.

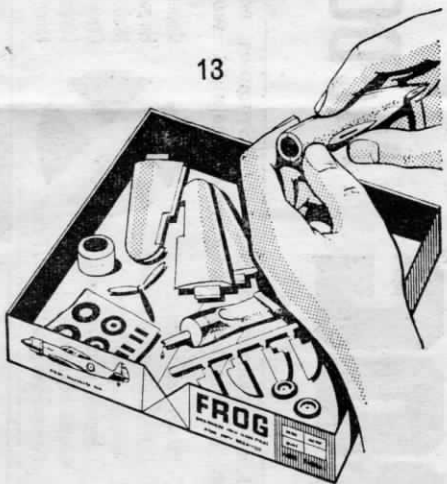

13

Aircraft Colour Guide

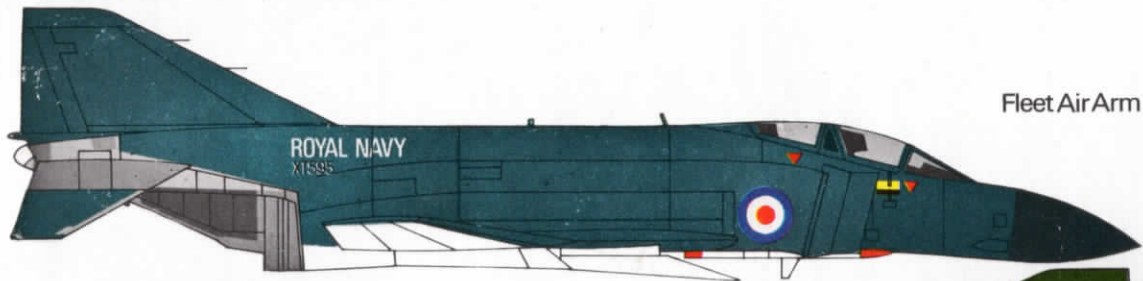

Fleet Air Arm

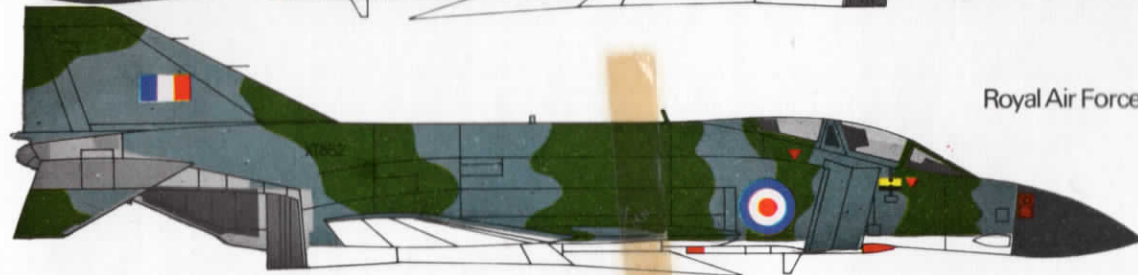
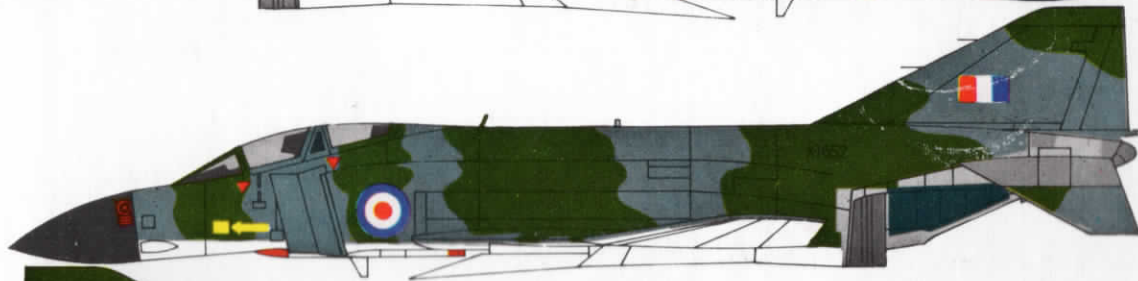

Royal Air Force

McDonnell Phantom F-4K or M

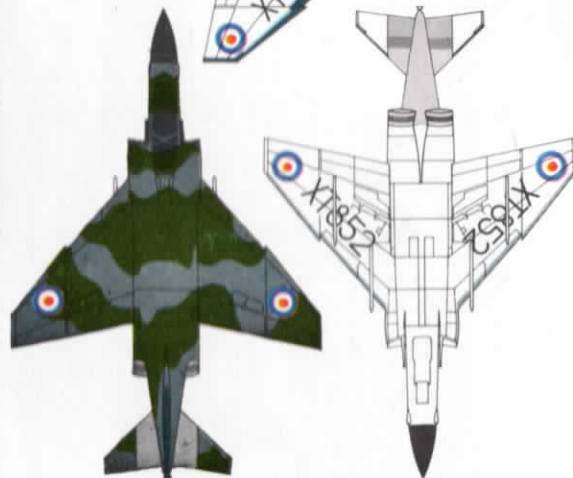
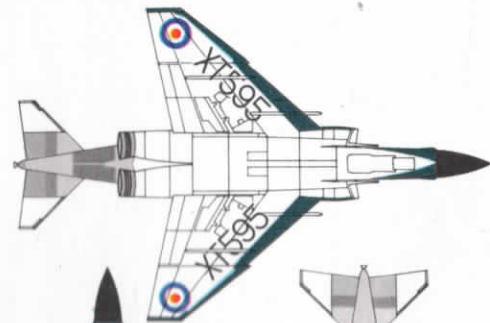



XT595



XT595



ROYAL NAVY



XT595

ROYAL NAVY

XT595



XT852

XT852



XT852



XT852

