

SAAB J-21 A

Heller HUMBROL

Rel: 80261

1-72





<p>Wingspan 11,60 m</p> <p>Length 10,45 m</p> <p>Max. weight 4150 kg</p> <p>Max. speed 640 km/h</p> <p>Range 750 km</p> <p>Weapons 1/20 mm cannon, 4/132 mm machine guns</p>	<p>Envergadura 11,60 m</p> <p>Longitud 10,45 m</p> <p>Peso máximo 4150 kg</p> <p>Velocidad máxima 640 km/h</p> <p>Radio de acción 750 km</p> <p>Armamento 1 cañón de 20 mm, 4 metralleras de 13,2 mm</p>	<p>Spannweite 11,60 m</p> <p>Länge 10,45 m</p> <p>Höchstgewicht 4150 kg</p> <p>Reichweite 750 km</p> <p>Bewaffnung 1/20 mm-Kanone, 4/132 mm-M.G.</p>	<p>Envergadura 11,60 m</p> <p>Longitud 10,45 m</p> <p>Peso máximo 4150 kg</p> <p>Velocidad máxima 640 km/h</p> <p>Radio de acción 750 km</p> <p>Armamento 1 cañón de 20 mm, 4 metralleras de 13,2 mm</p>	<p>Spannweite 11,60 m</p> <p>Länge 10,45 m</p> <p>Höchstgewicht 4150 kg</p> <p>Reichweite 750 km</p> <p>Bewaffnung 1/20 mm-Kanone, 4/132 mm-M.G.</p>	<p>Spannweite 11,60 m</p> <p>Länge 10,45 m</p> <p>Peso máximo 4150 kg</p> <p>Velocidad máxima 640 km/h</p> <p>Radio de acción 750 km</p> <p>Armamento 1 cañón de 20 mm, 4 metralleras de 13,2 mm</p>	<p>Spannweite 11,60 m</p> <p>Länge 10,45 m</p> <p>Peso máximo 4150 kg</p> <p>Velocidad máxima 640 km/h</p> <p>Radio de acción 750 km</p> <p>Armamento 1 cañón de 20 mm, 4 metralleras de 13,2 mm</p>
--	--	--	--	--	--	--

SWEDEN- Saab J 21 A Flygflötilij 6/2nd Squadron

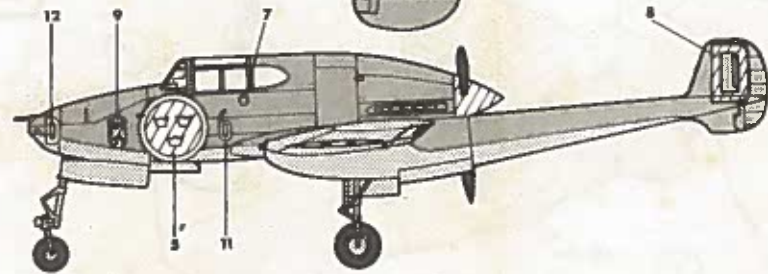
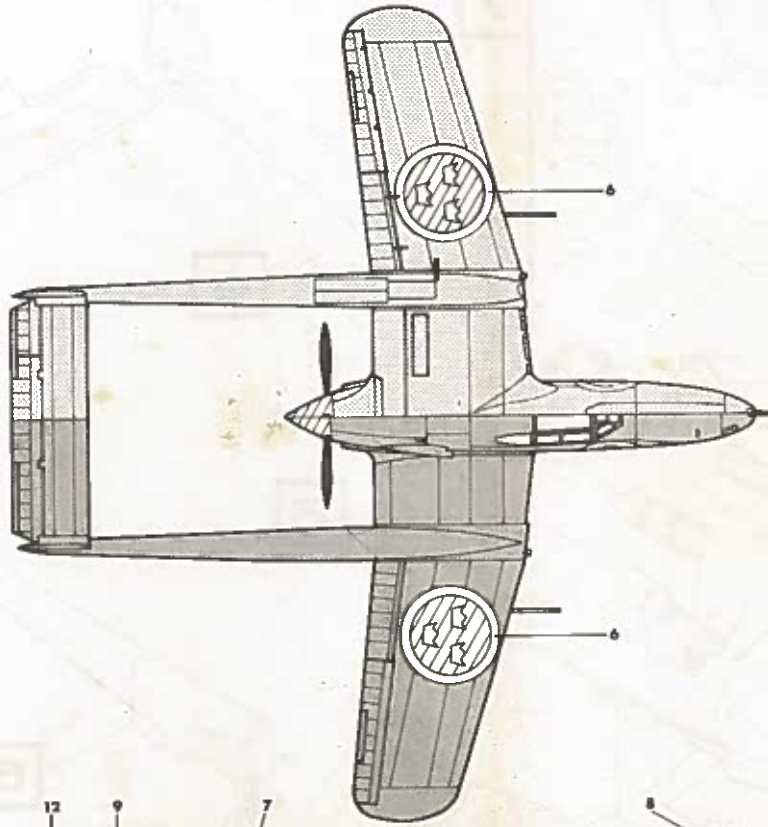
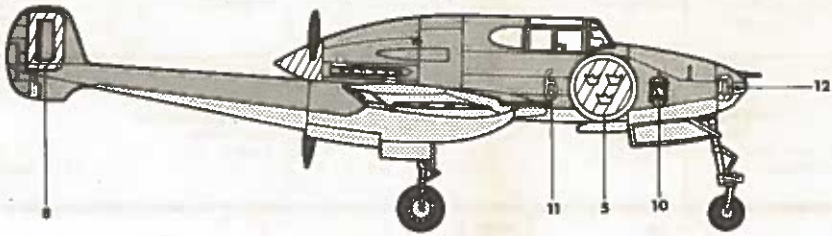

SWEDEN- Saab J 21 A Flygflötilij 9/1st Squadron



-  60/7003
-  109/7019
-  123/7030
-  65/7064

