

Mikoyan-Gurevich MiG-17F

History in brief

The Mikoyan-Gurevich MiG-17, NATO reporting name: Fresco, China: Shenyang J-5, Poland: PZL-Mielec Lim-5. Is a high-subsonic fighter aircraft produced in the USSR from 1952 and operated by numerous air forces in many variants. It is an advanced development of the very similar appearing MiG-15 of the Korean War.

The MiG-17 first saw combat in 1958 over the Straits of Taiwan and was used as an effective threat against supersonic fighters of the United States in the Vietnam War. It was also briefly known as the "Type 38, by U.S. Air Force designation prior to the development of NATO codes.

Plastic parts/Plastikové díly

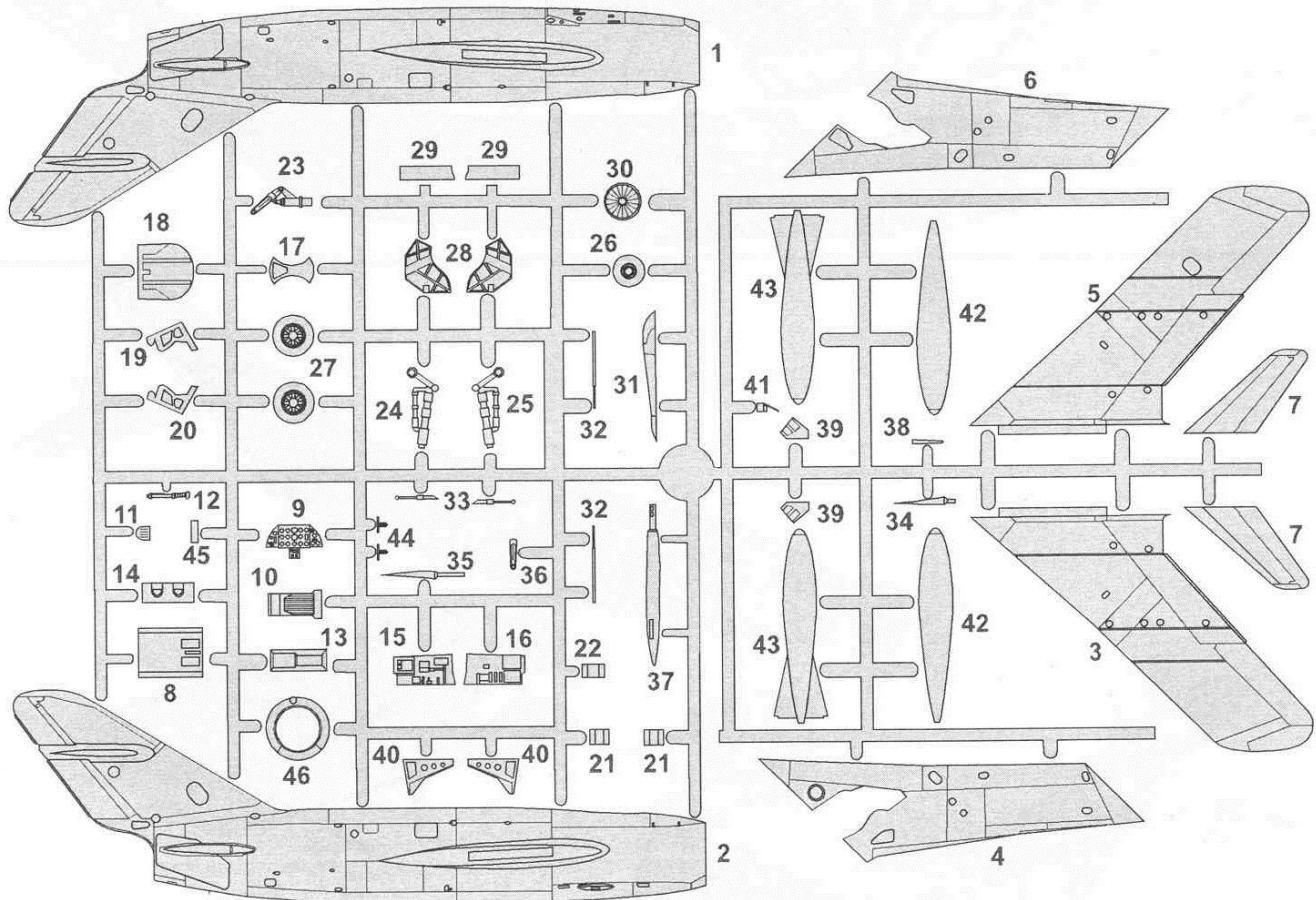

Clear parts/
Průhledné díly  T1

Symbols/Symboly

 Vyvrtat	 Vteřinové lepidlo	 Odstranit	 Zbrousit
 Vyrobit	 Volba	 Ohnout	 Tmel

	Colour name	Humbrol		Colour name	Humbrol
A	Black	H33	F	Deck Green	H88
B	Aluminium	H56	G	Gunmetal	H53
C	Silver	H11	H	Tyre	H85
D	Sea Grey	H27	I	Red Brown	H100
E	Dark Brown	H29	J	Natural Wood	H110

8

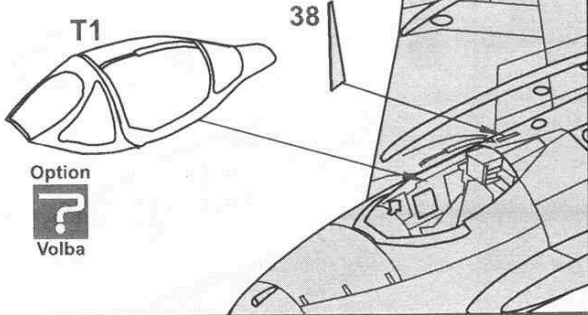

9

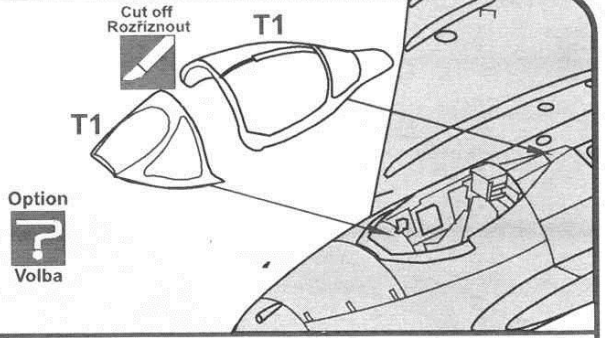

MiG-17F

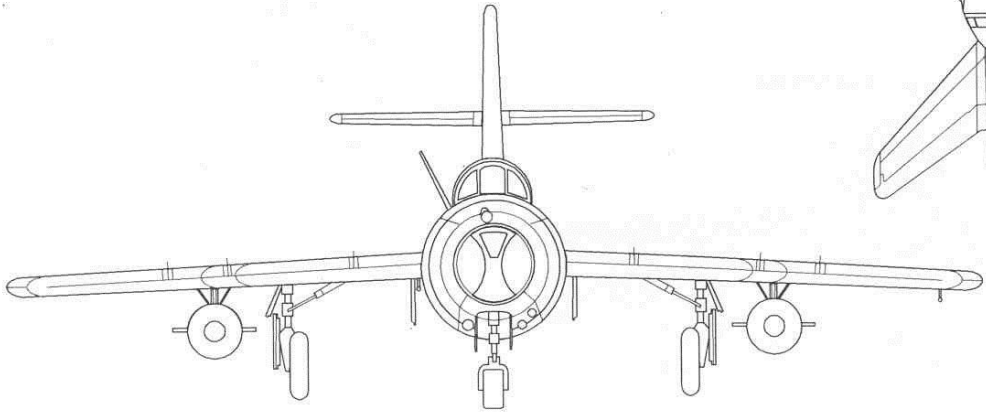
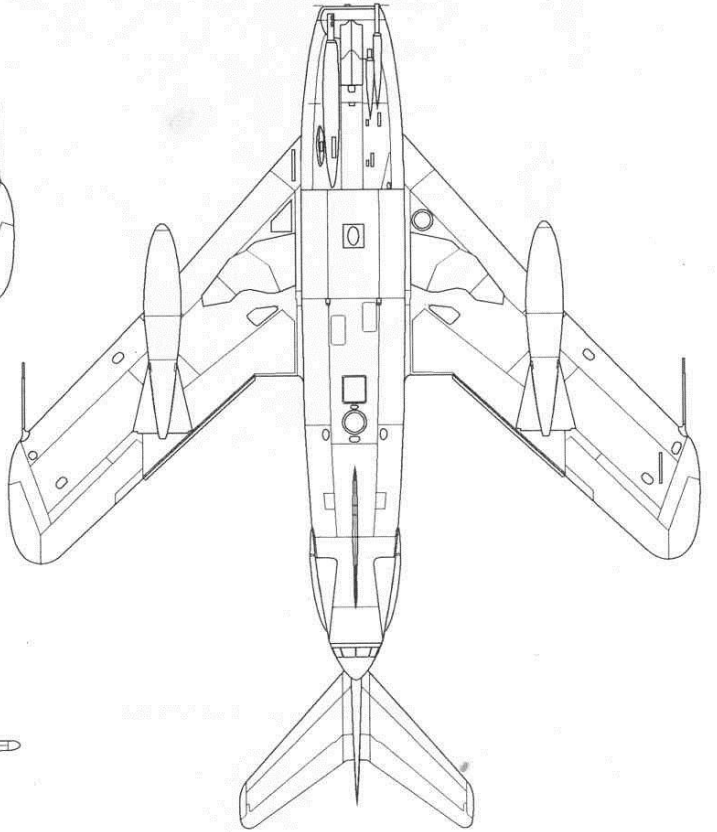
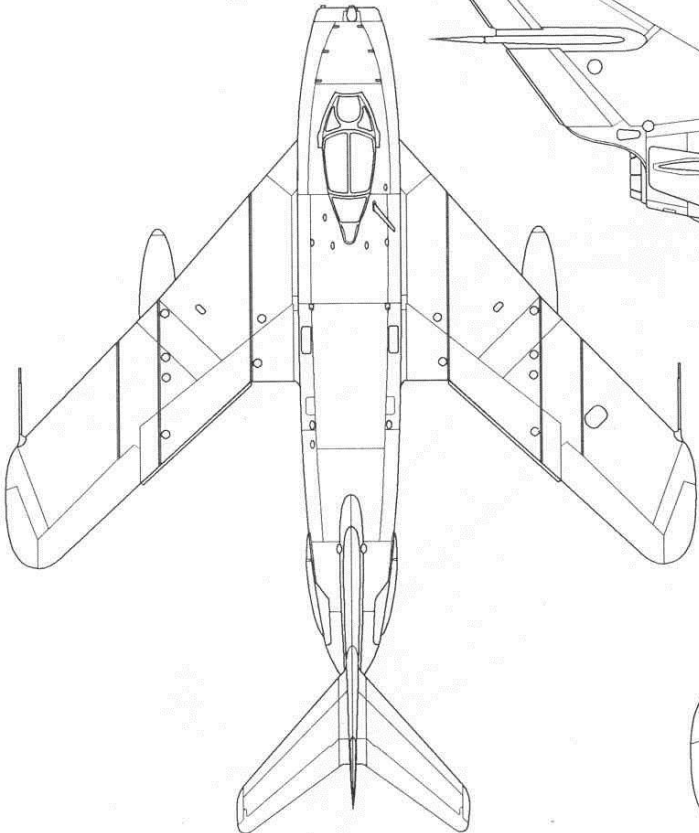
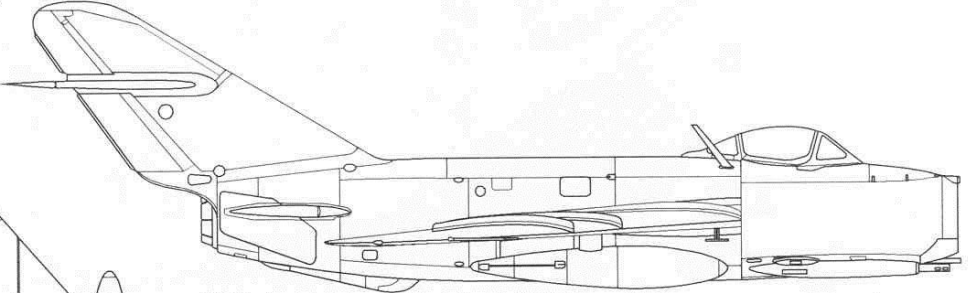
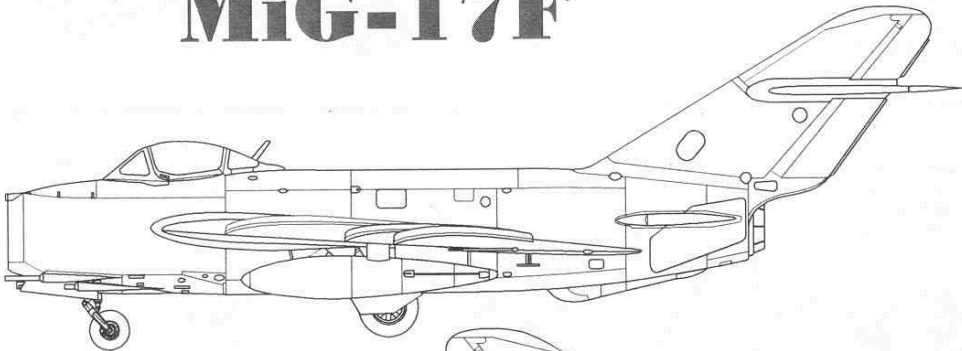

1

MiG-17F, 0872, Czechoslovak Air Force, personal plane General-Lieut. Josef Vosahlo, 1957.

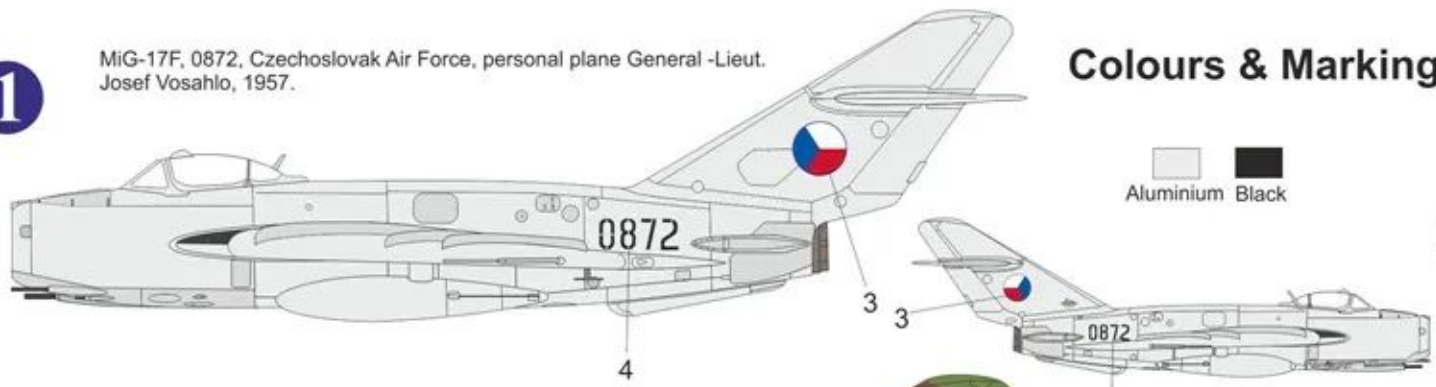

Colours & Markings

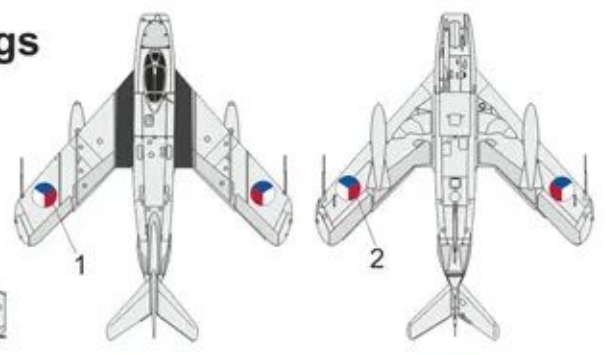

2

MiG-17F, Red 991, JG-7, NVA, DDR, 1973.

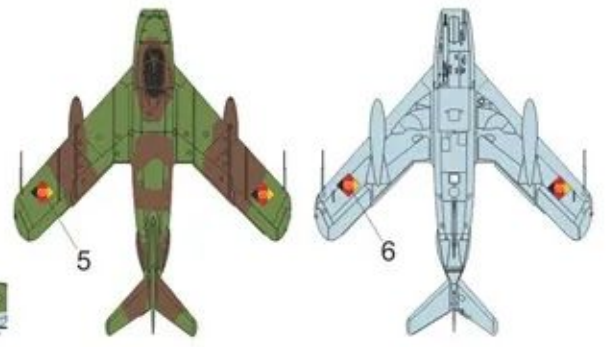

3

MiG-17F, Red 96, Bulgarian Air Force, 1983.

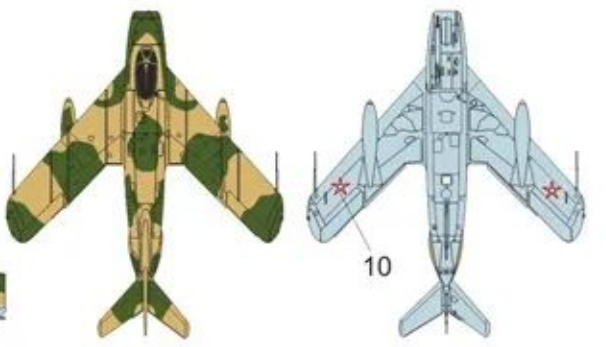
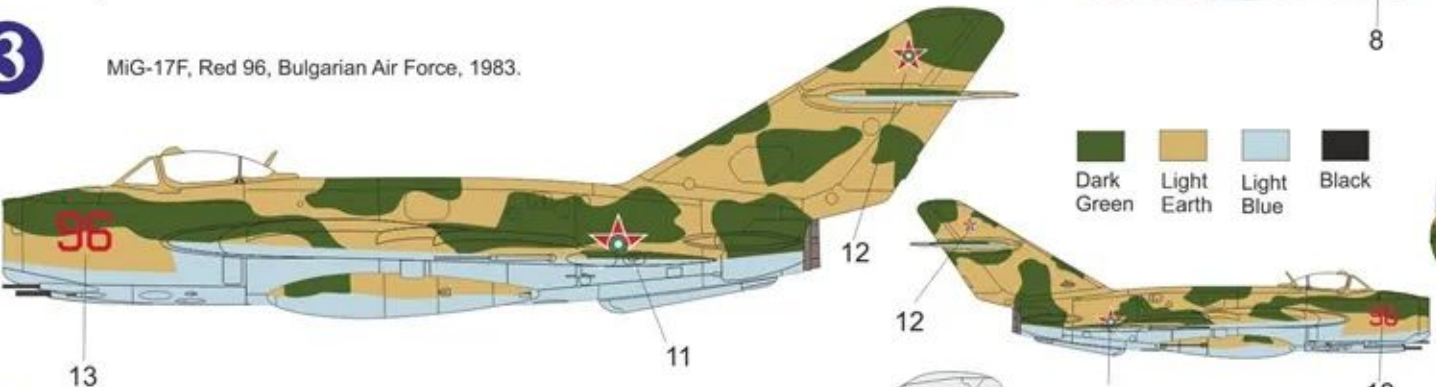

4

MiG-17F, Yellow 44, Army Air Force of the USSR, 1958.

