



1:32
RESIN MODEL
CAT. NO. 32-41
www.lukgraph.pl

General characteristics

Crew: 2
Length: 31 ft 8 in (9.65 m)
Wingspan: 46 ft 5 in (14.15 m)
Height: 13 ft (4.0 m)
Empty weight: 3,810 lb (1,728 kg)
Gross weight: 5,410 lb (2,454 kg)
Powerplant: 1 × Bristol Jupiter VI 9-cylinder
air-cooled radial piston engine, 420 hp (310 kW)
Propellers: 2-bladed fixed-pitch propeller

Performance

Maximum speed: 129 mph (208 km/h, 112 kn)
Cruise speed: 110 mph (180 km/h, 96 kn)
Range: 360 mi (580 km, 310 nmi)
Service ceiling: 18,800 ft (5,700 m)
Rate of climb: 1,140 ft/min (5.8 m/s)
Time to altitude: 15 minutes to 10,000 ft (3,000 m)
Wing loading: 11.1 lb/sq ft (54 kg/m²)
Power/mass: 0.0776 hp/lb (0.1276 kW/kg)

Armament

One 0.303 inch (7.7 mm) forward firing Vickers gun
one Lewis gun on Scarff ring on rear cockpit,
Bombs: Up to 580 lb (260 kg) of bombs

The Westland Wapiti was a British two-seat general-purpose military single-engined biplane of the 1920s. It was designed and built by Westland Aircraft Works to replace the Airco DH.9A in Royal Air Force service. First flying in 1927, the Wapiti entered service with the RAF in 1928, and remained in production until 1932, a total of 565 being built. It equipped twenty squadrons of the RAF, both overseas (particularly in India and Iraq) and at home, remaining in RAF service until 1940, also being used by the Air Forces of Australia, Canada, South Africa and India. It also formed the basis for the Westland Wallace which partly replaced the Wapiti in RAF use.

3D PRINTED PARTS

CAREFULLY REMOVE THE SUPPORTS (GREY COLOR) BEST WITH A SAW, THE COMPONENTS ARE HARD BUT FRAGILE. BEFORE PAINTING USE PRIMER, SOME ITEMS MAY REQUIRE GRINDING VISIBLE LAYERS OF THE 3D PRINT

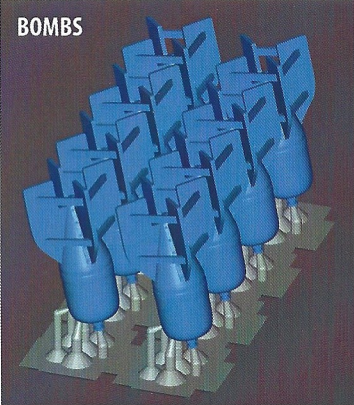

BOMBS

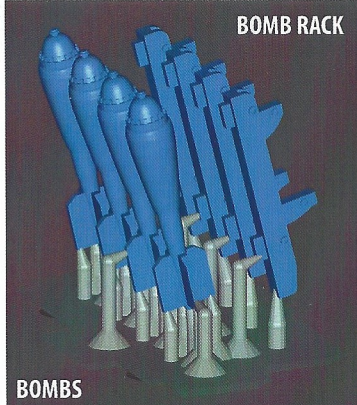

BOMB RACK

BOMBS

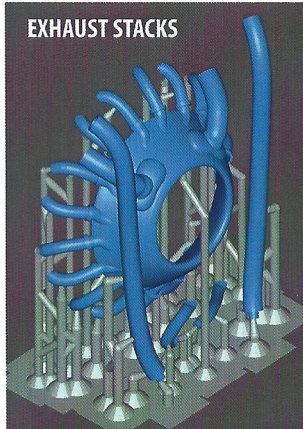

EXHAUST STACKS

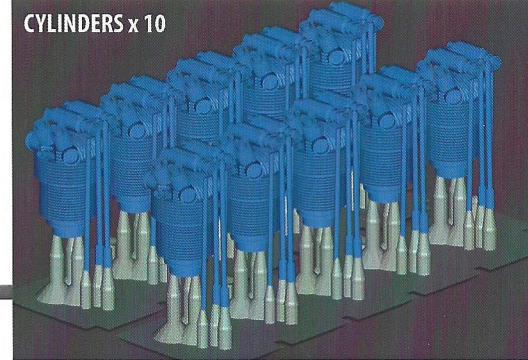

CYLINDERS x 10

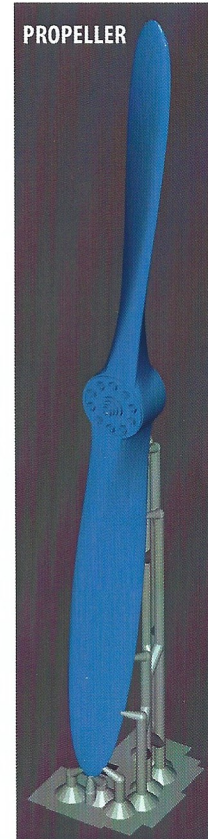

PROPELLER

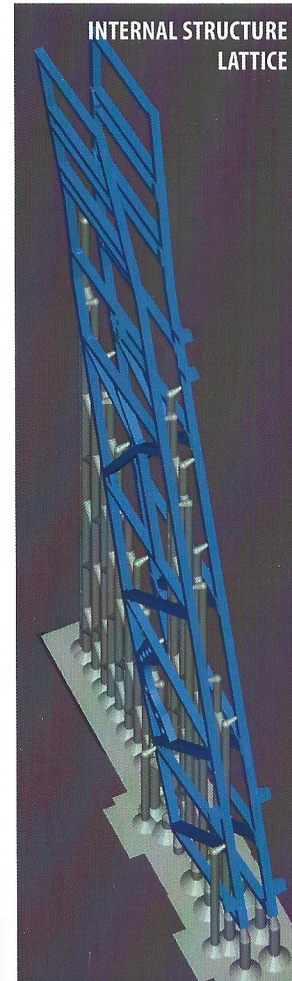

INTERNAL STRUCTURE LATTICE

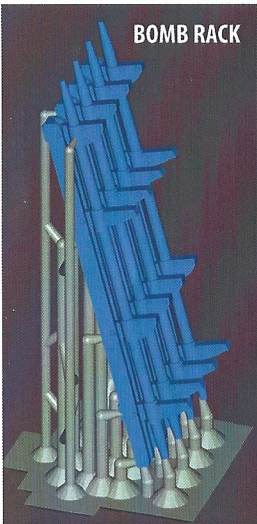

BOMB RACK



BUMPERS

CENTER WING SUPPORT

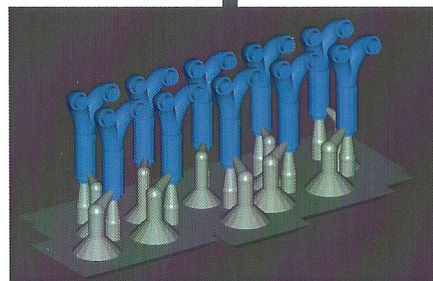

JUPITER VIII F

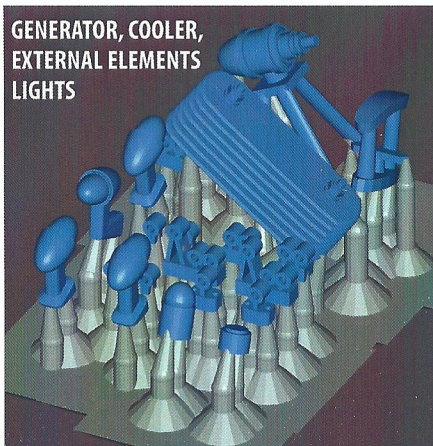

GENERATOR, COOLER, EXTERNAL ELEMENTS LIGHTS

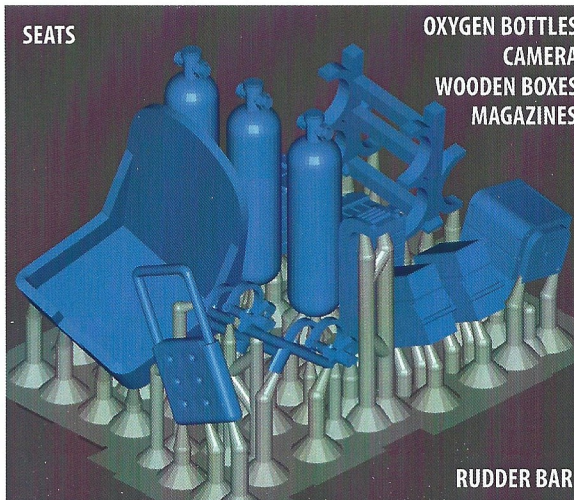

SEATS

OXYGEN BOTTLES
CAMERA
WOODEN BOXES
MAGAZINES

RUDDER BAR

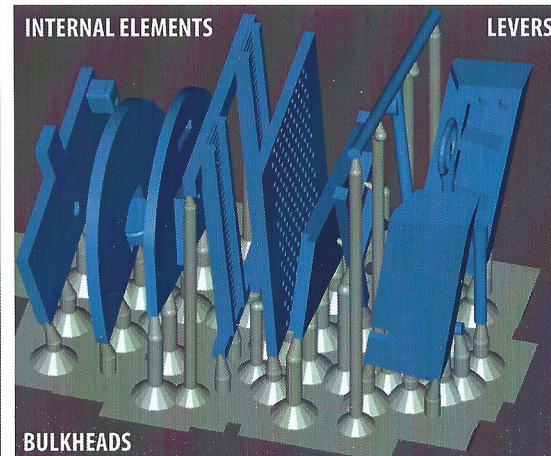

INTERNAL ELEMENTS

LEVERS

BULKHEADS

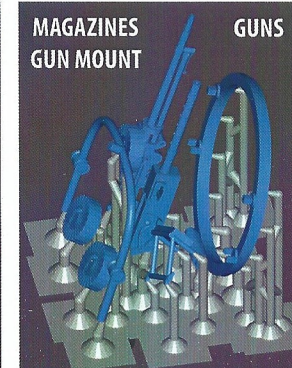

MAGAZINES
GUN MOUNT

GUNS

1:32

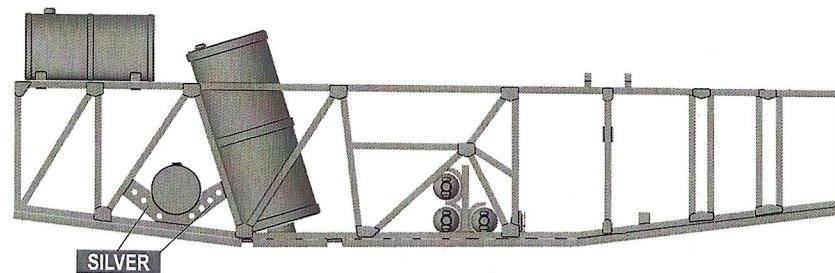
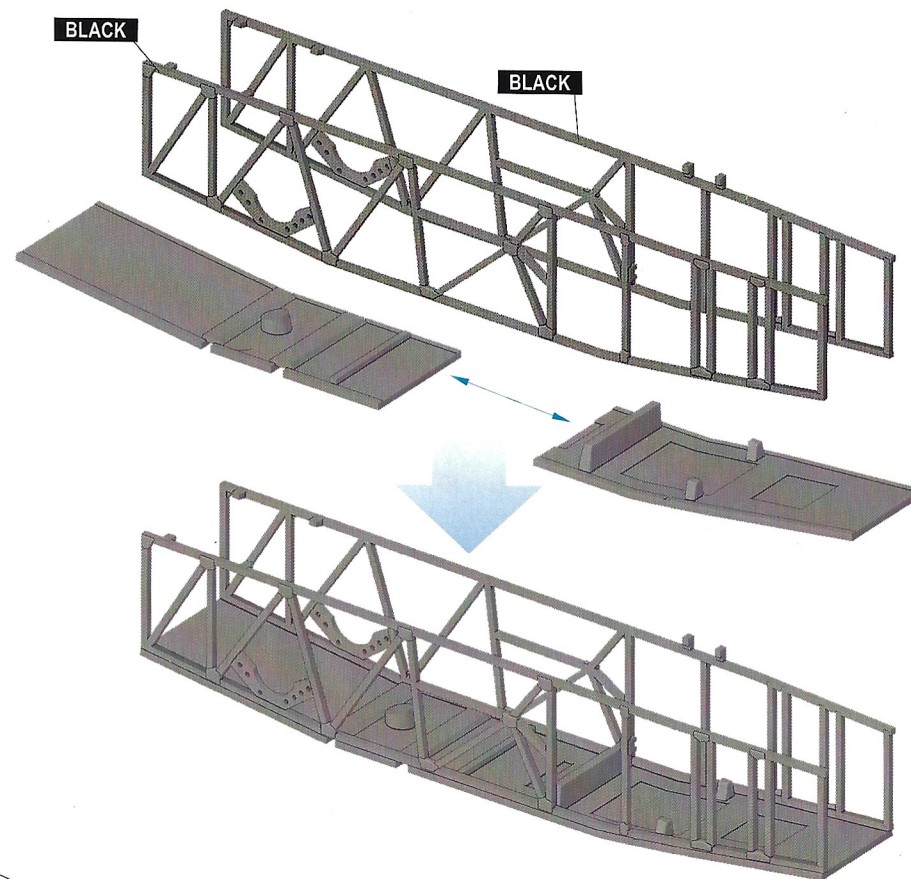
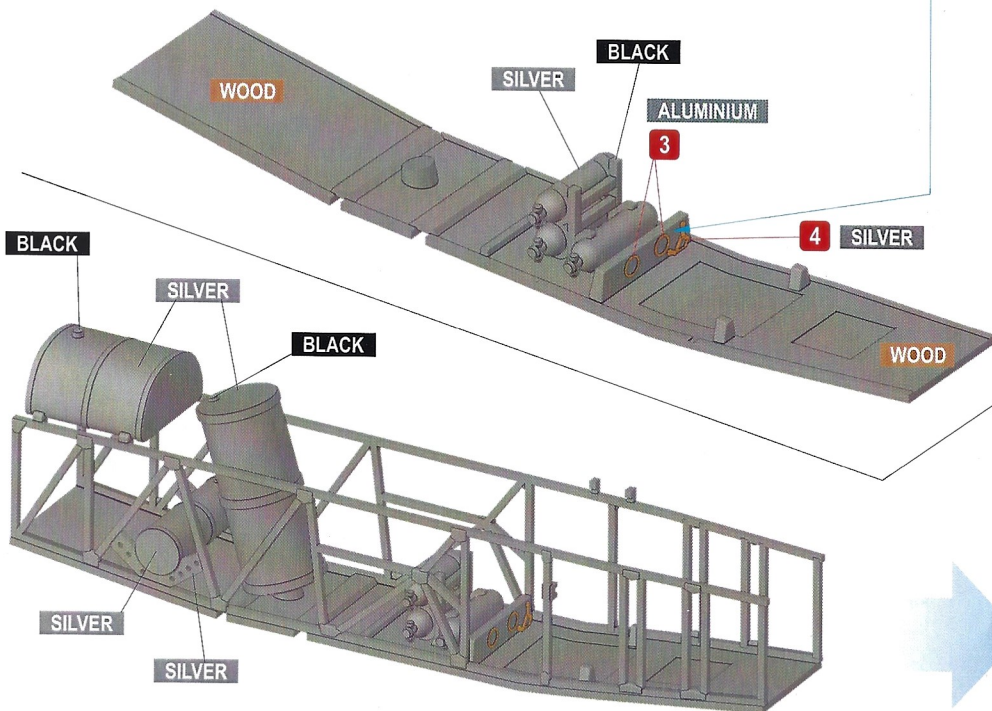
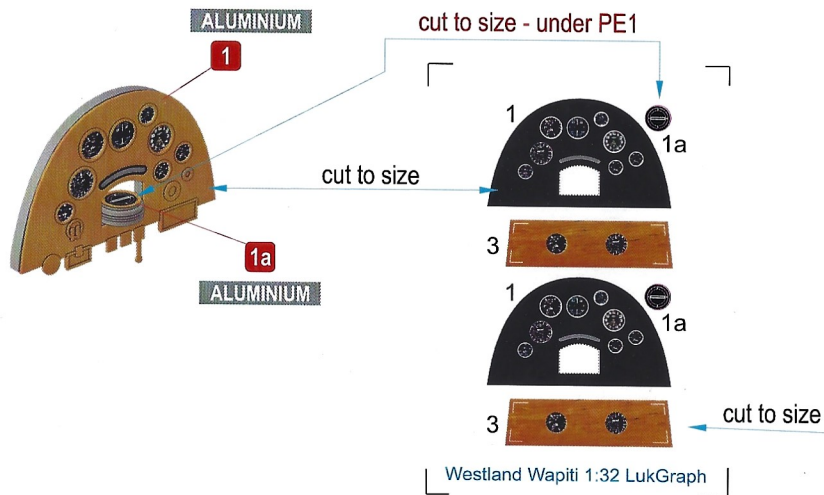

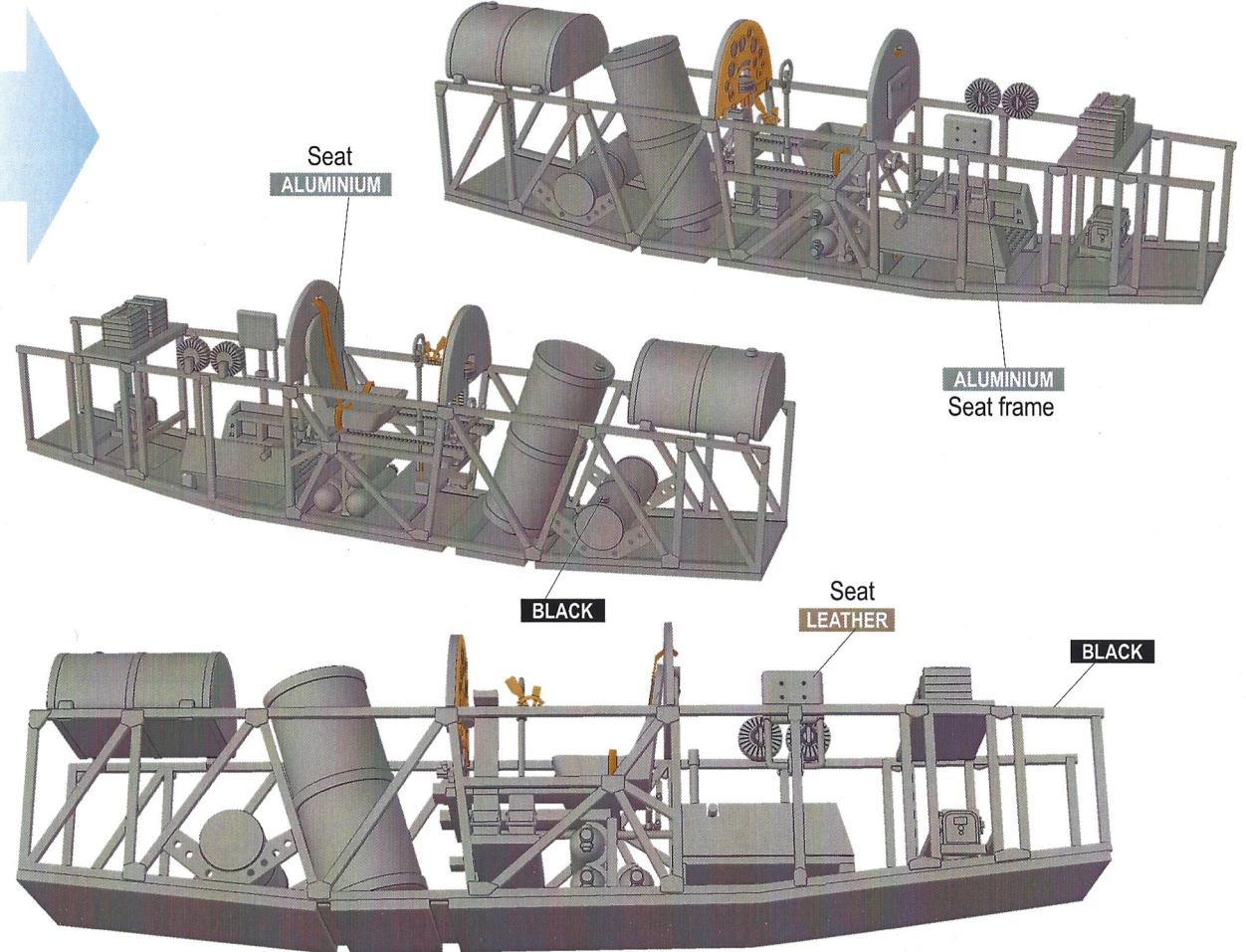
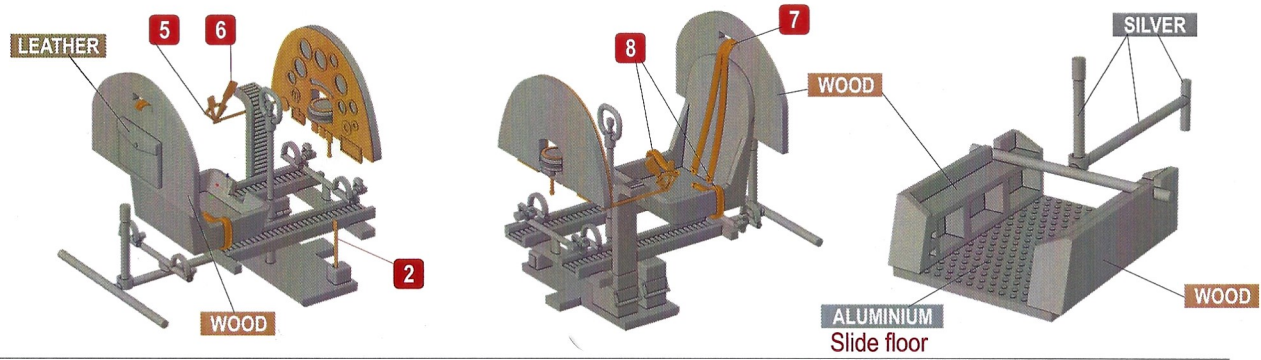
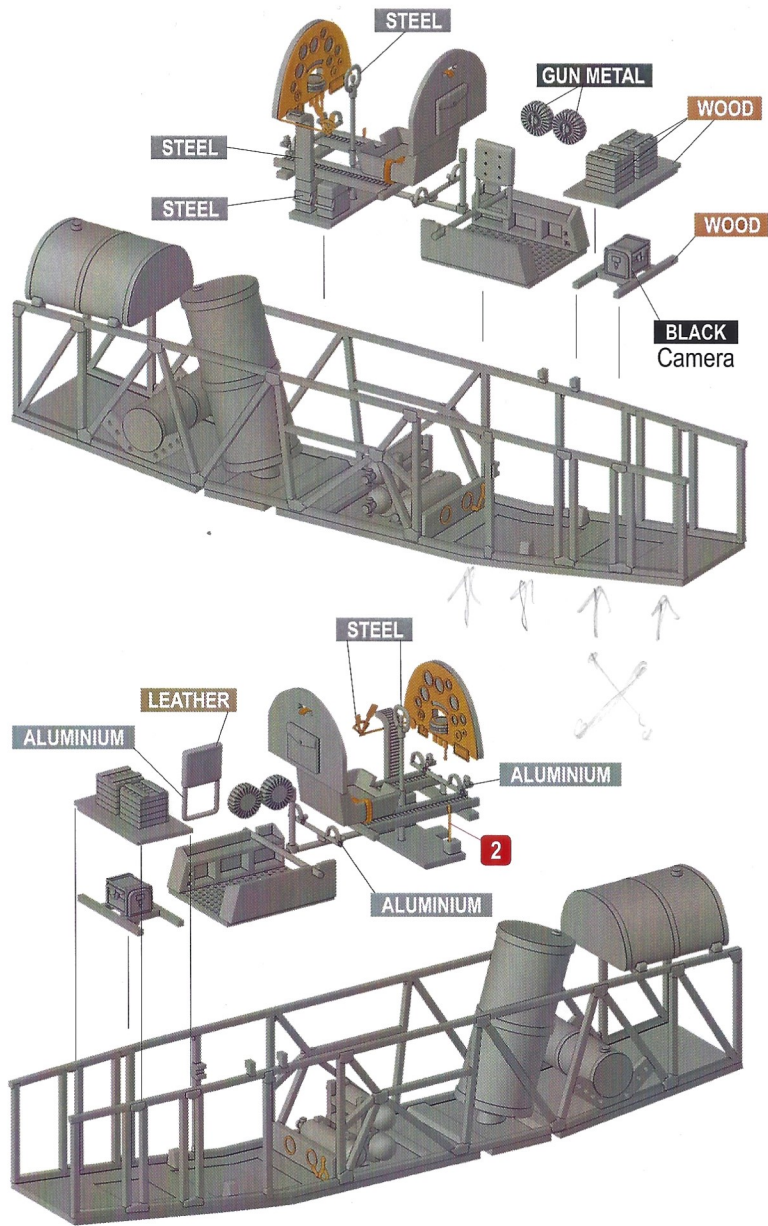

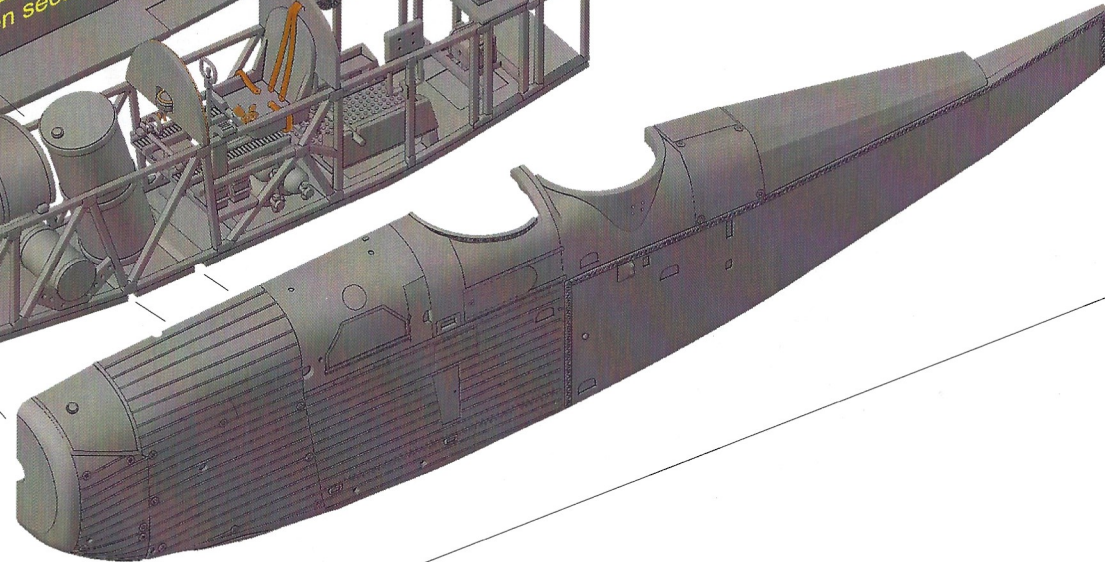
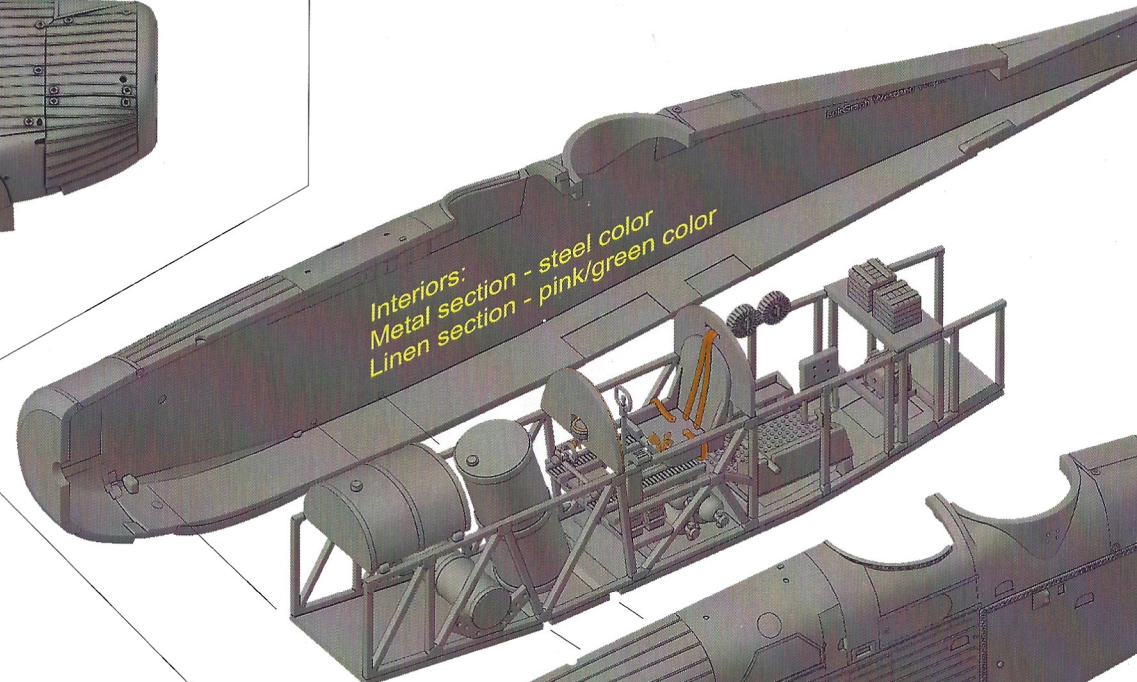
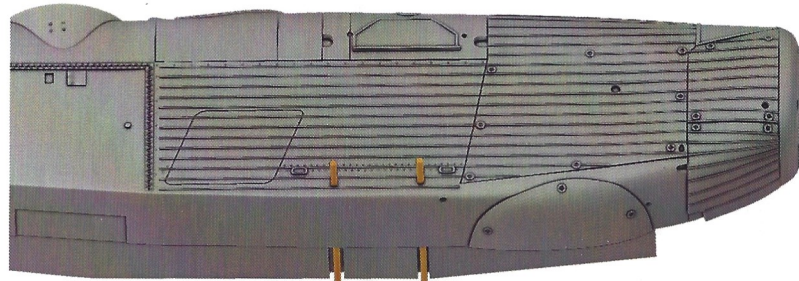

Attention:

The mounting rails (in the floor) should align with the holes in the fuselage.
Put the rods into the wings (there are mounting holes in the wings).
This is a perfectly rigid model structure.

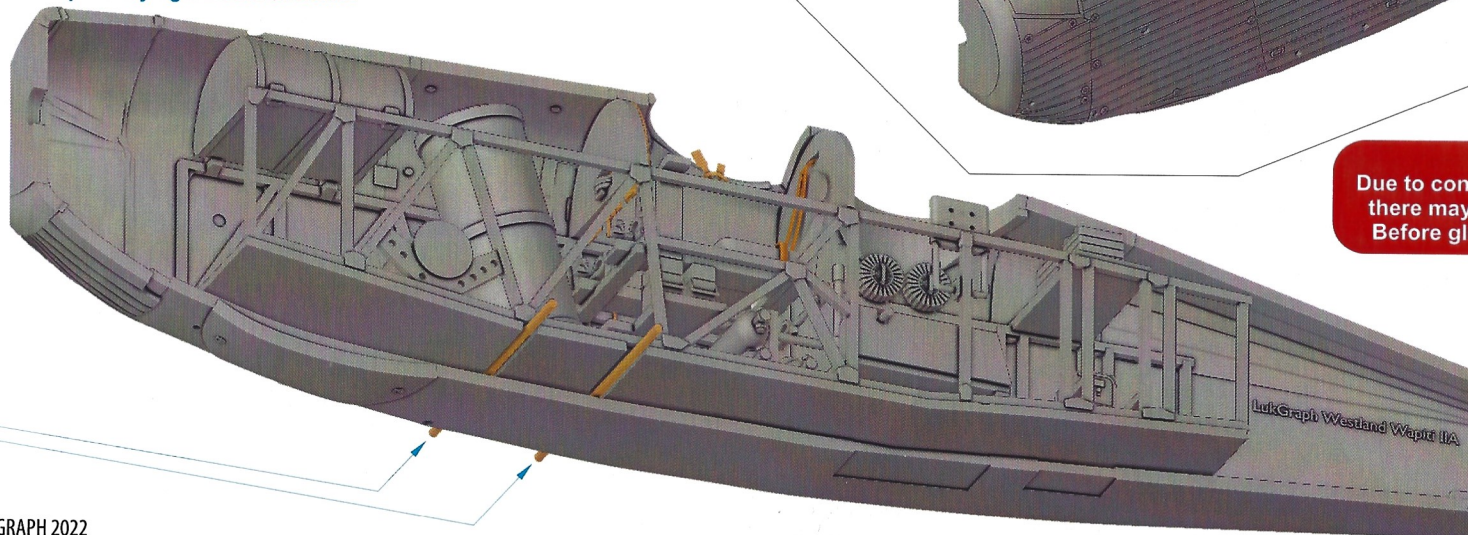

Attention:

Due to contractions of the cast resin (dimensional changes), there may be problems with the alignment of the fuselage.
Before gluing, please fit the interior with the fuselage dry.

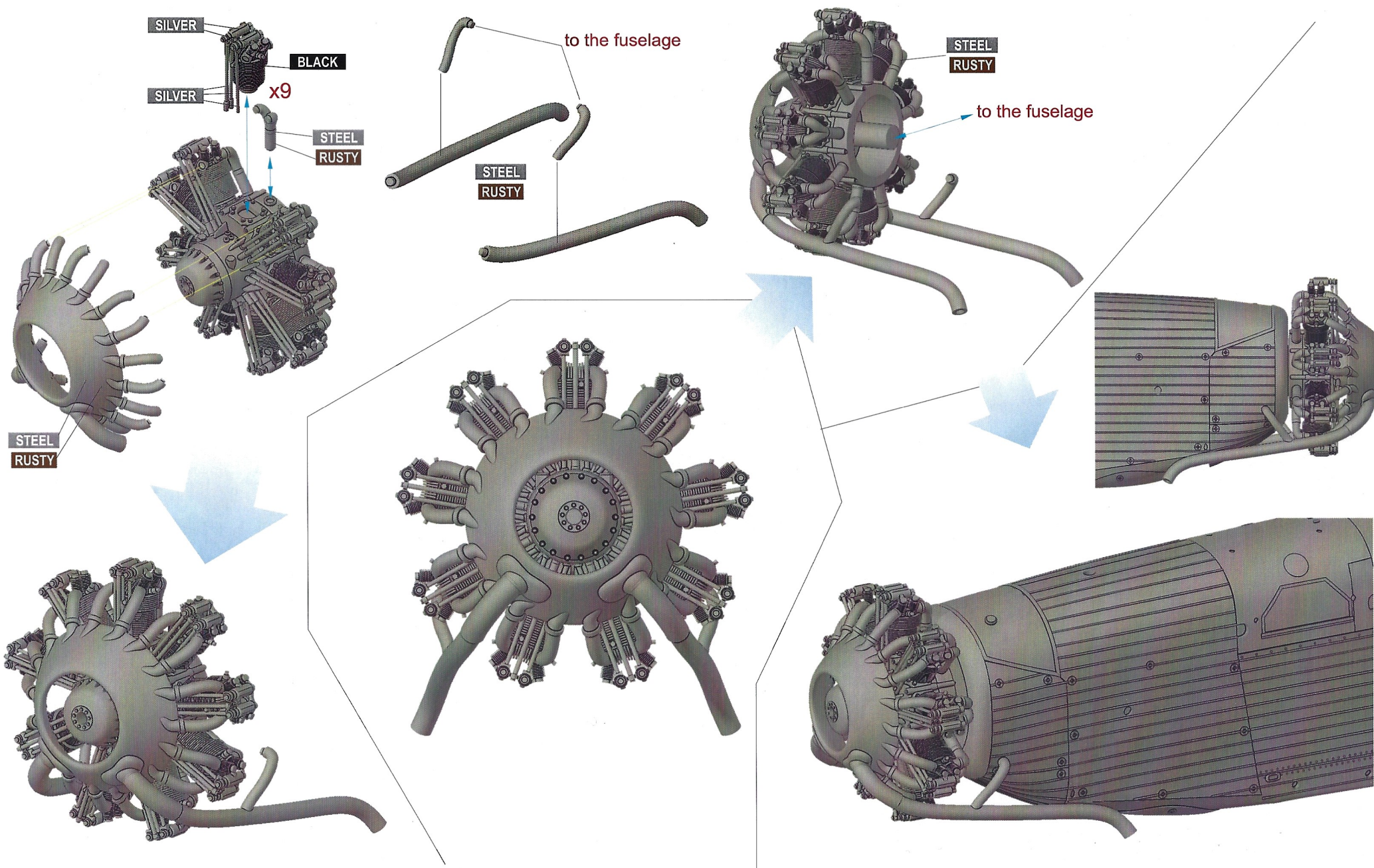

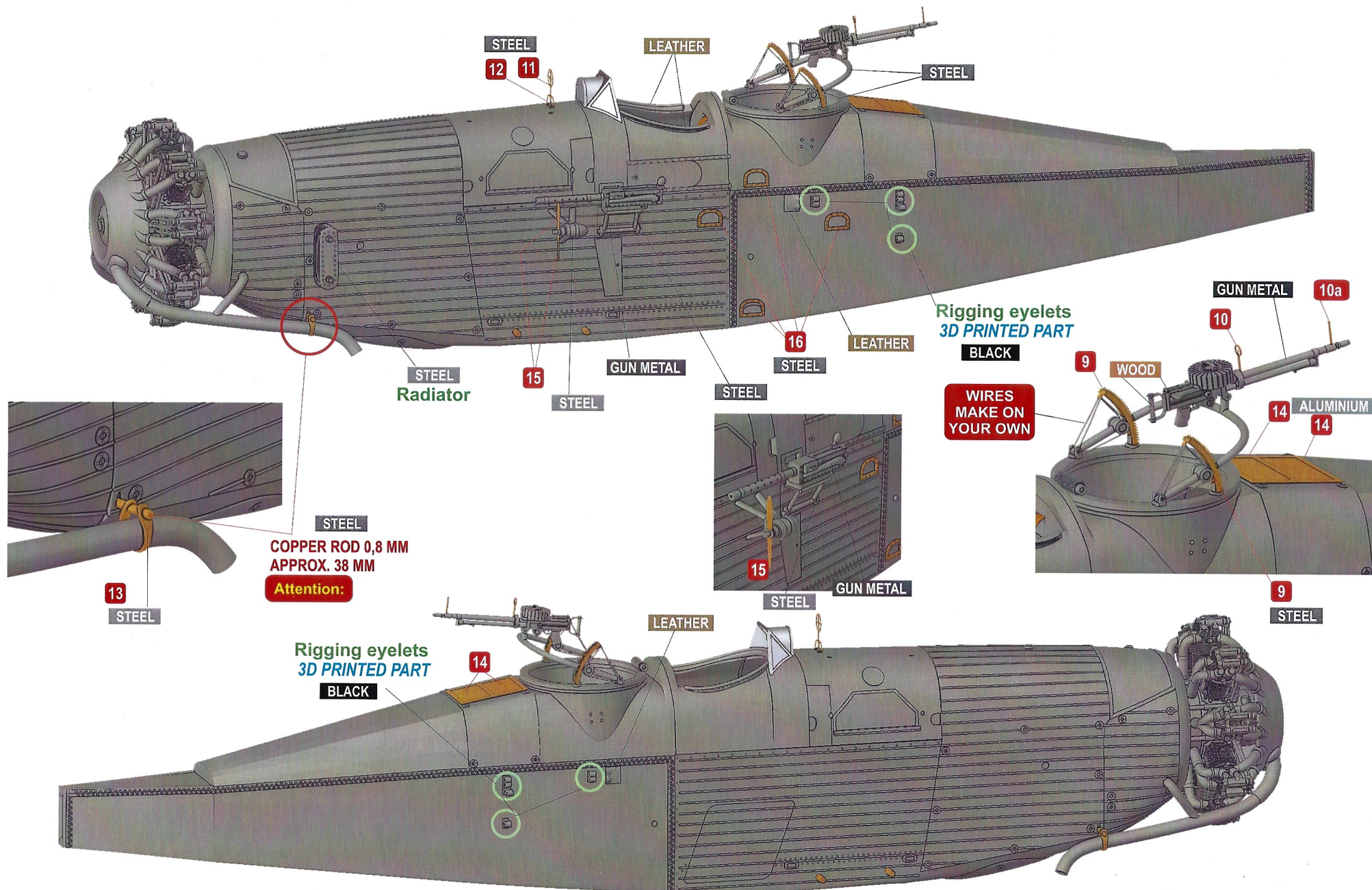

Put the wires into the fuselage
be careful not to damage the interior
(drill holes in the fuselage before)

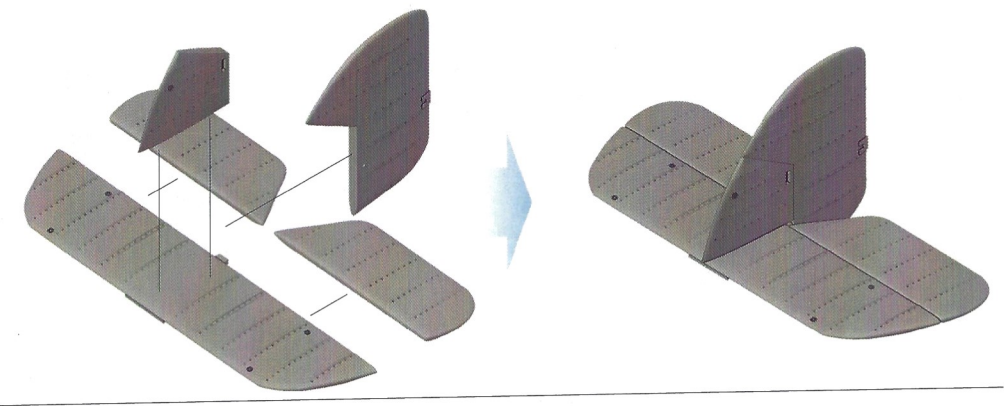
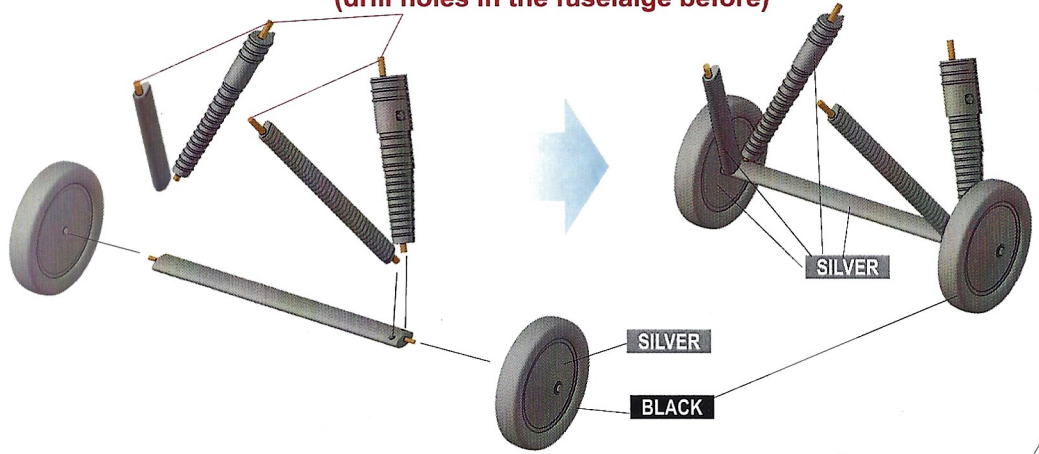

center wing struts

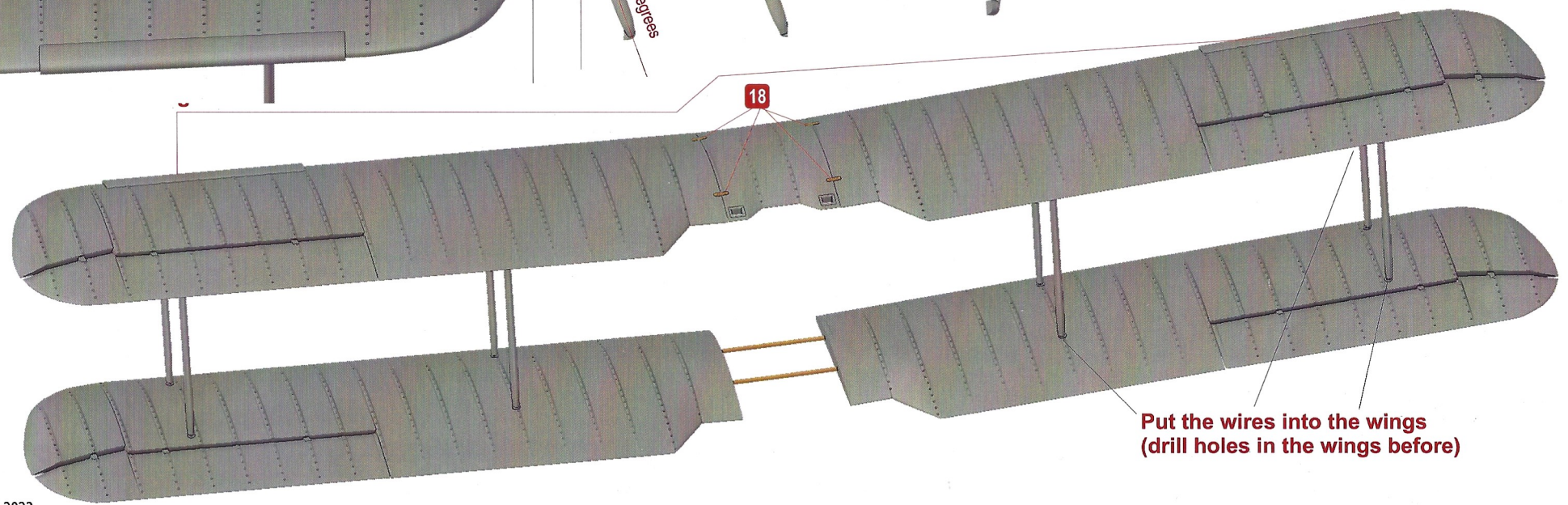
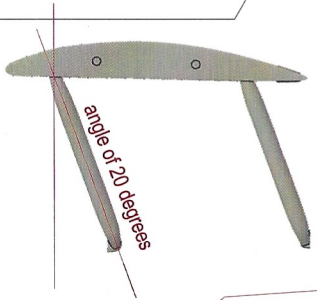
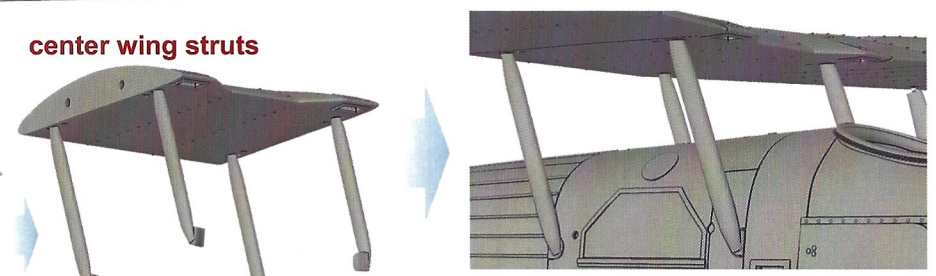

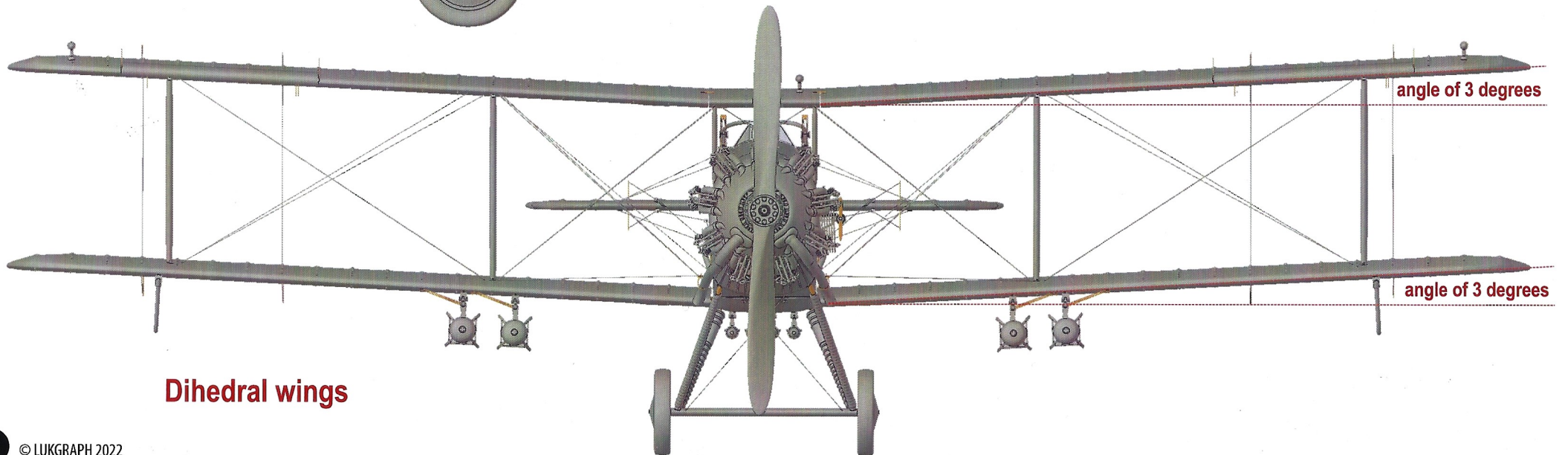
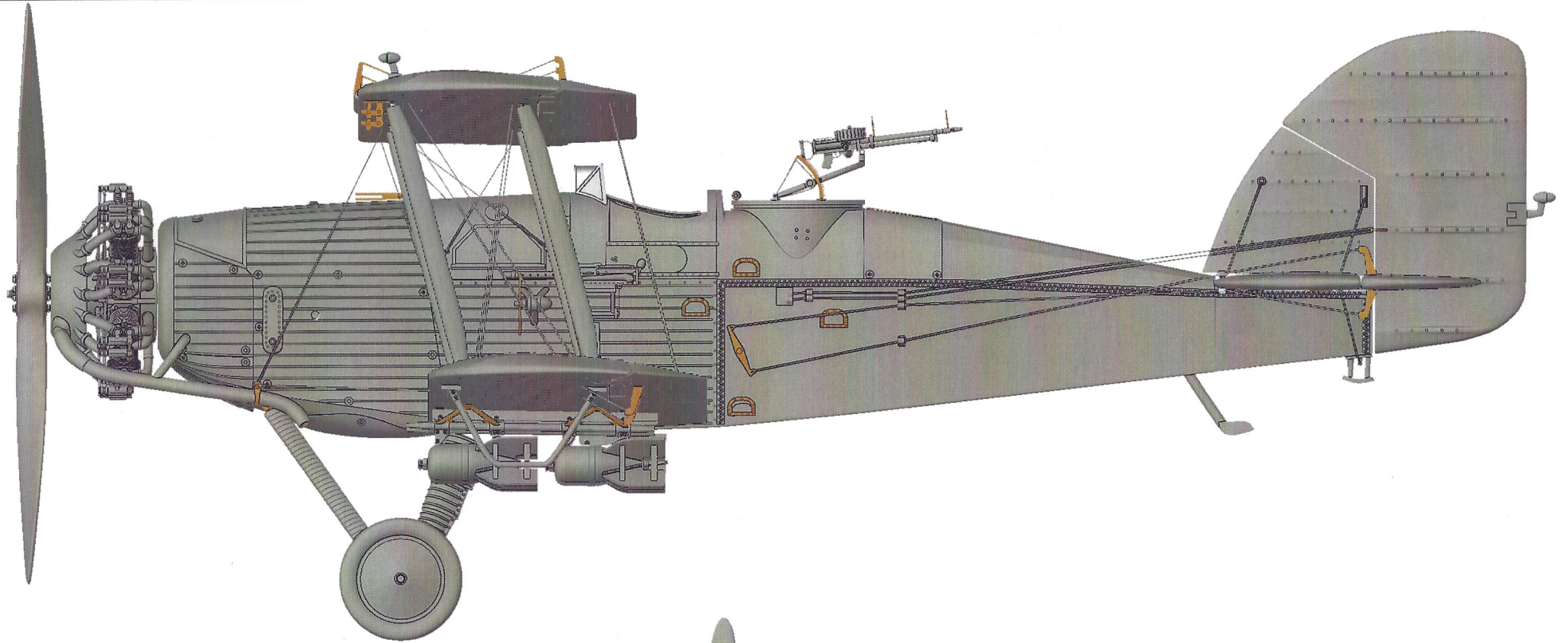

Dihedral wings

Finishing the model

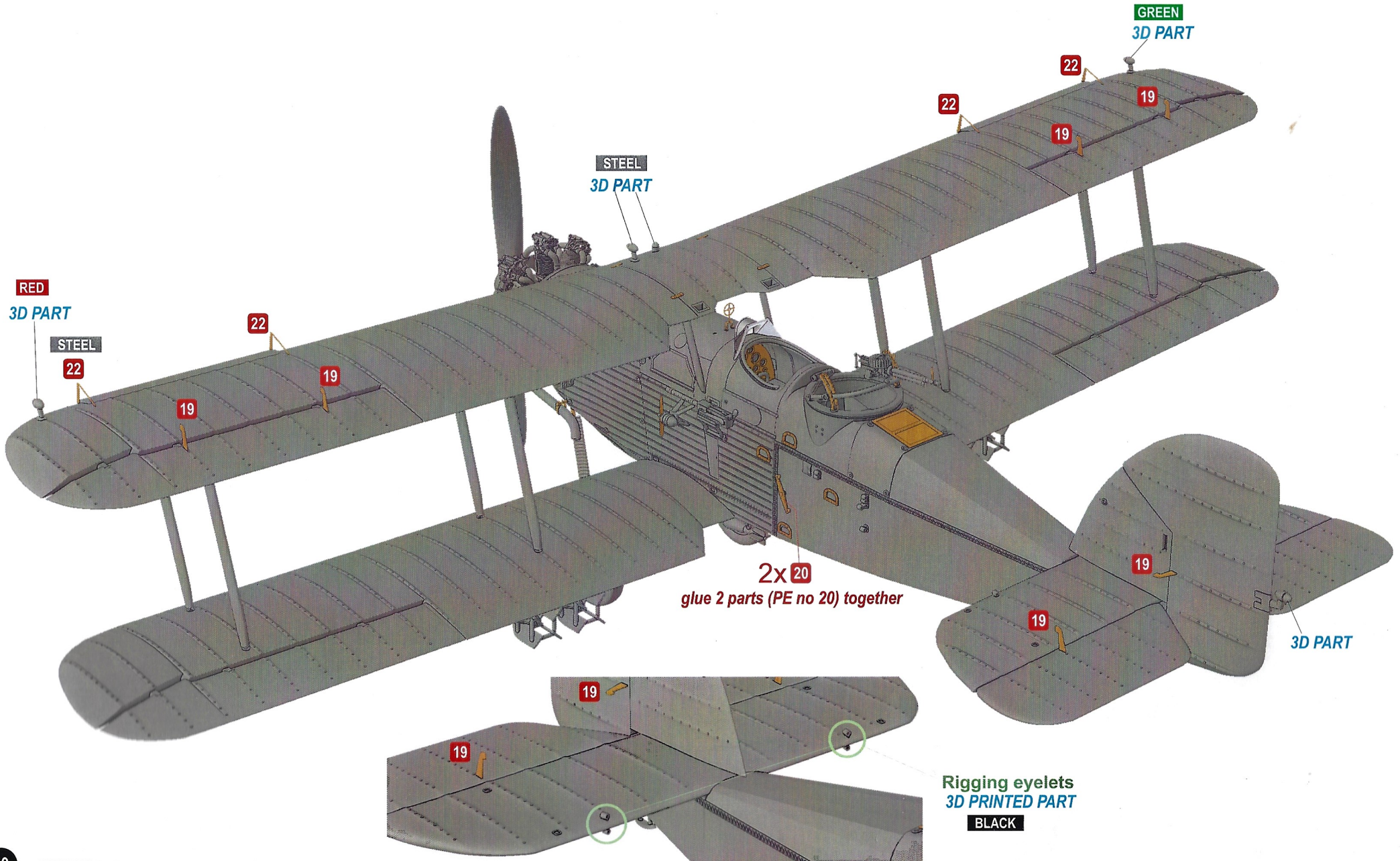

Finishing the model

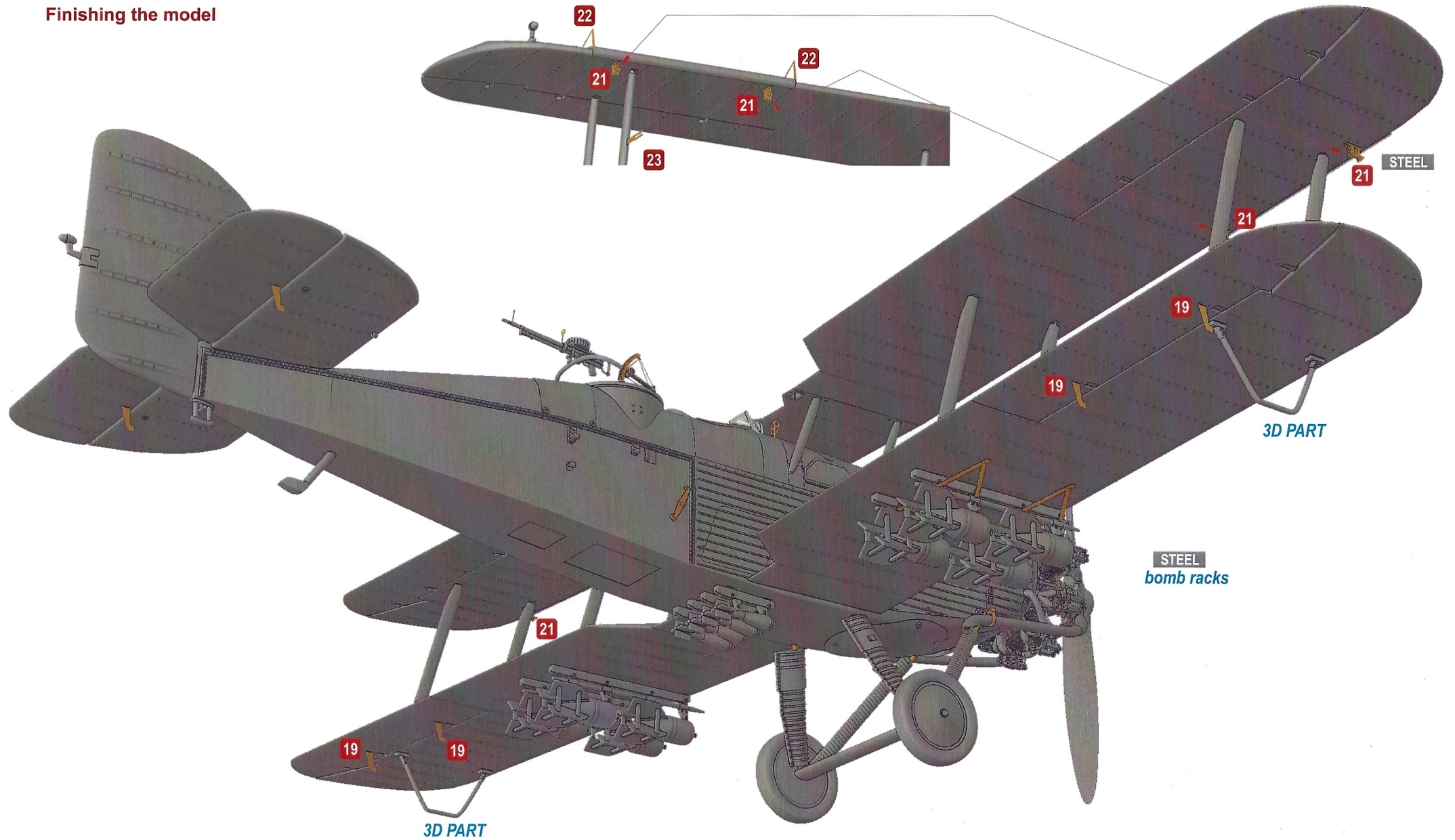

Finishing the model

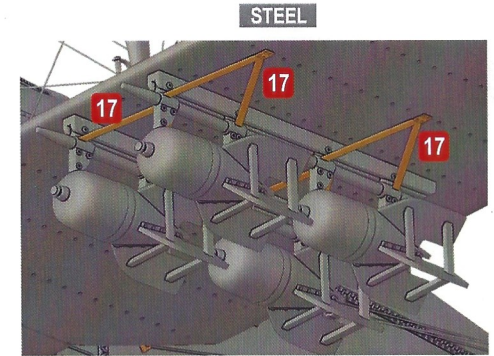
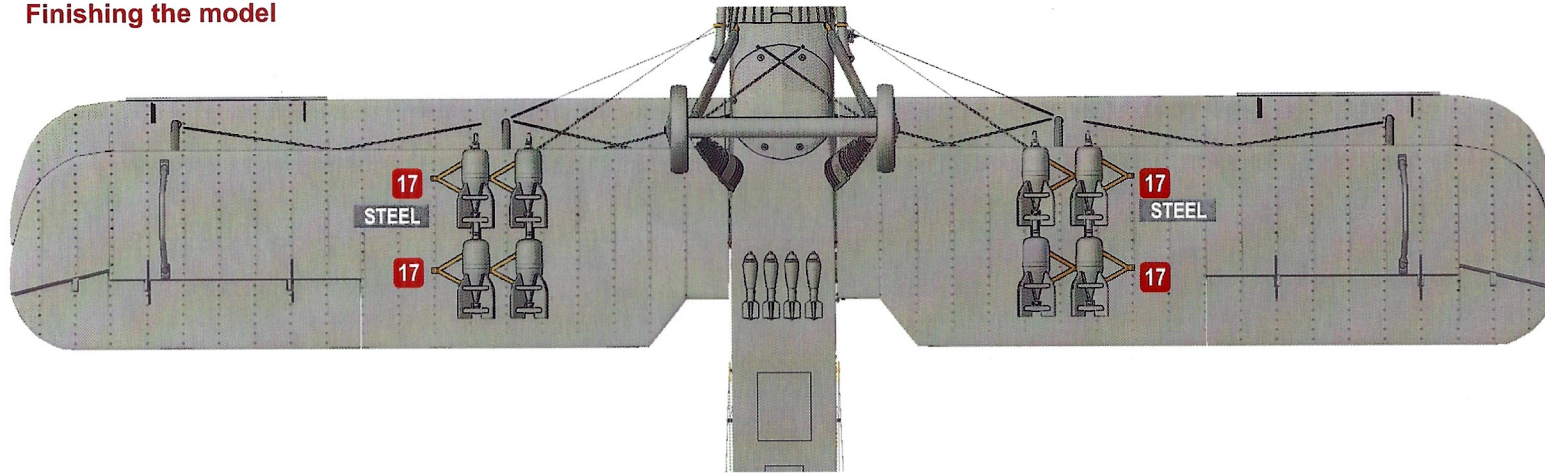

STEEL
bomb racks

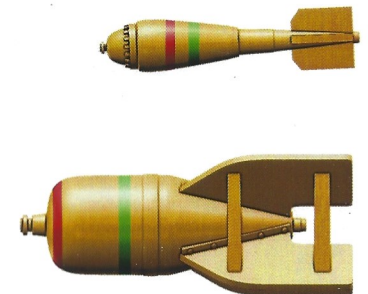
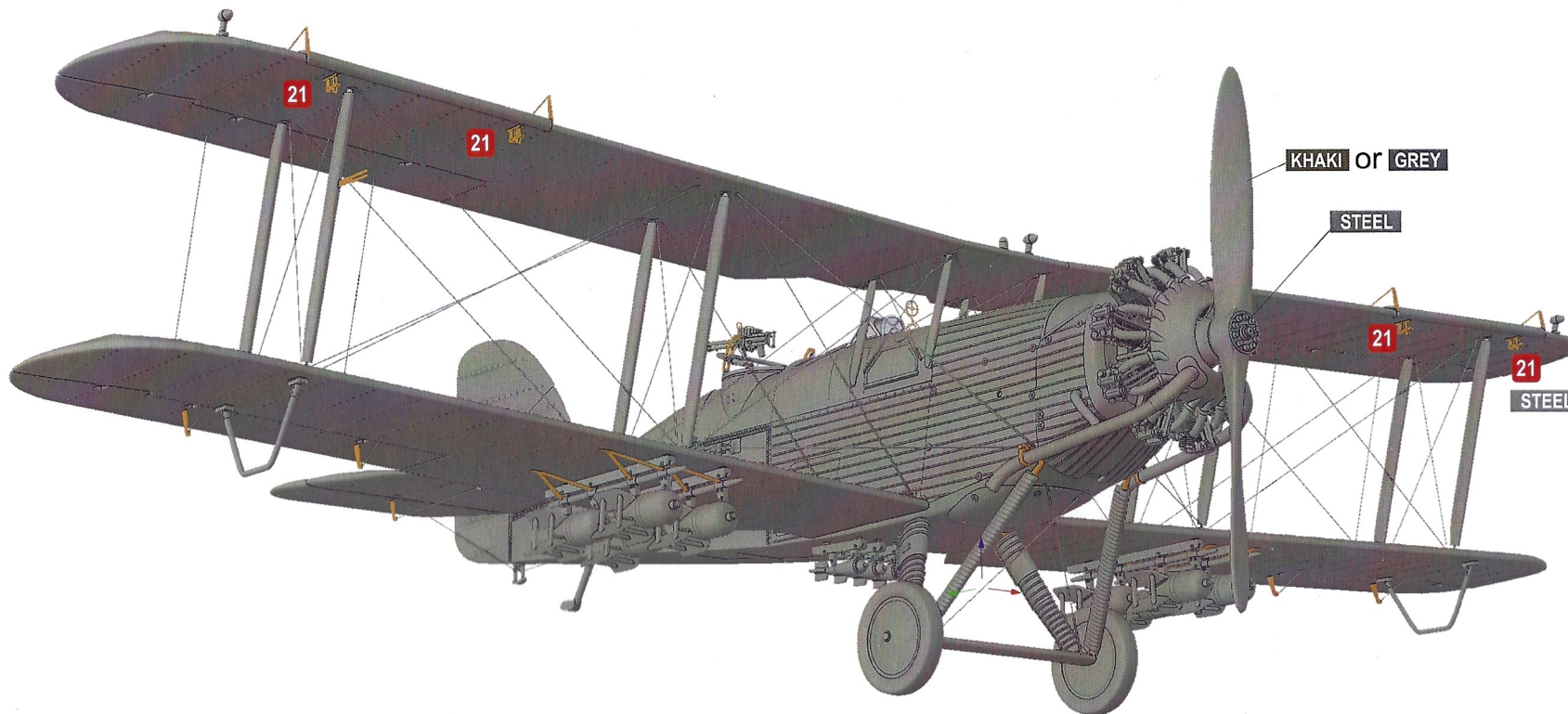
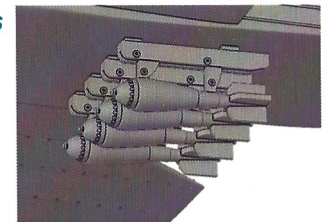

RIGGING SCHEME

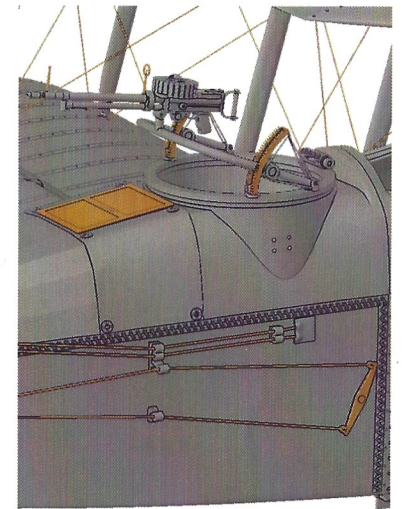
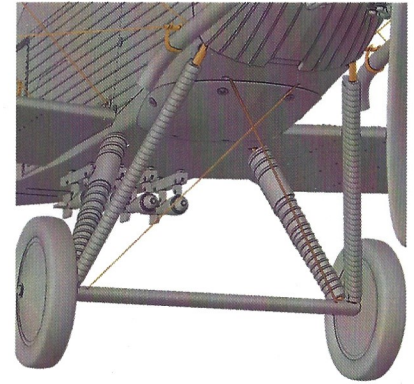
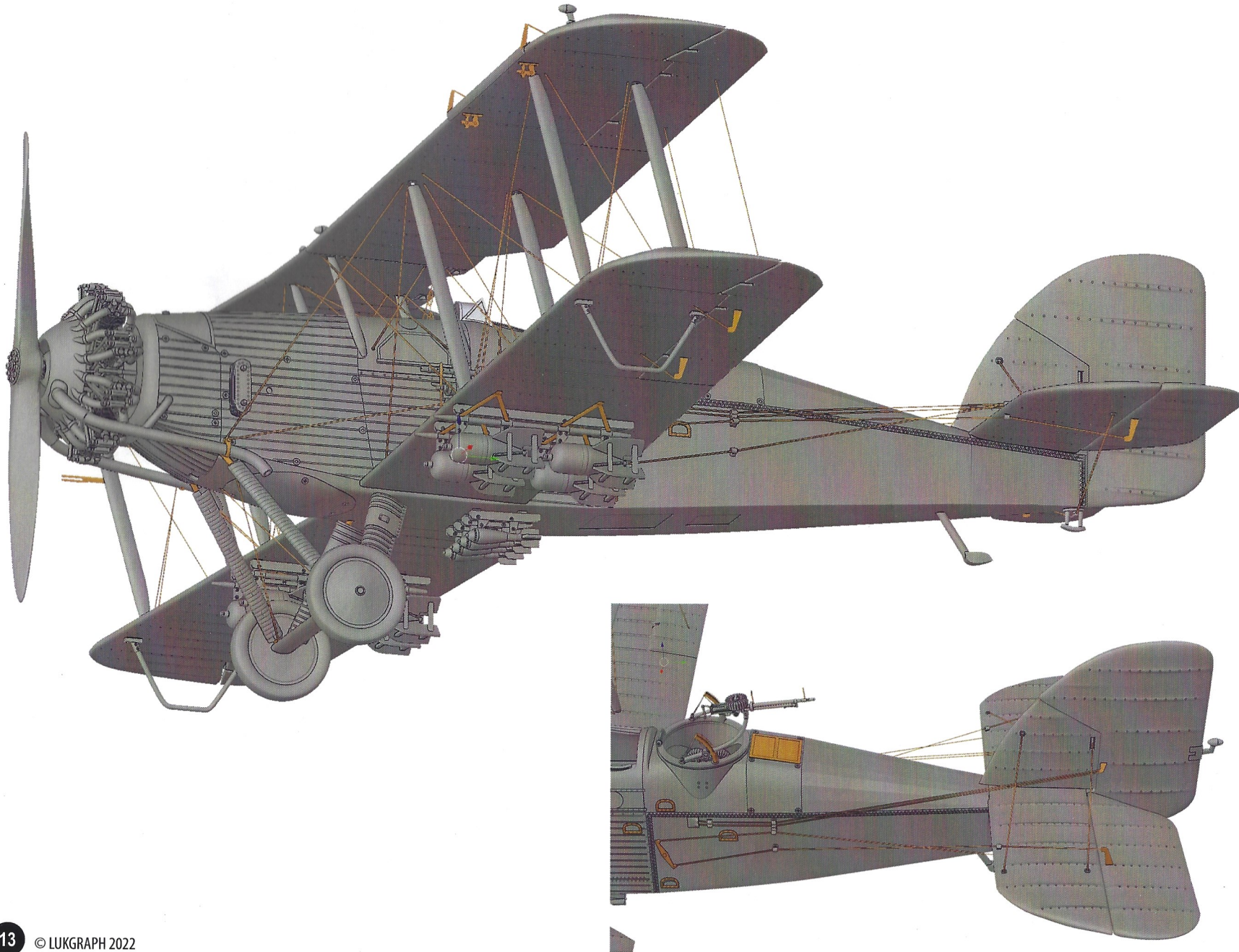

RIGGING SCHEME

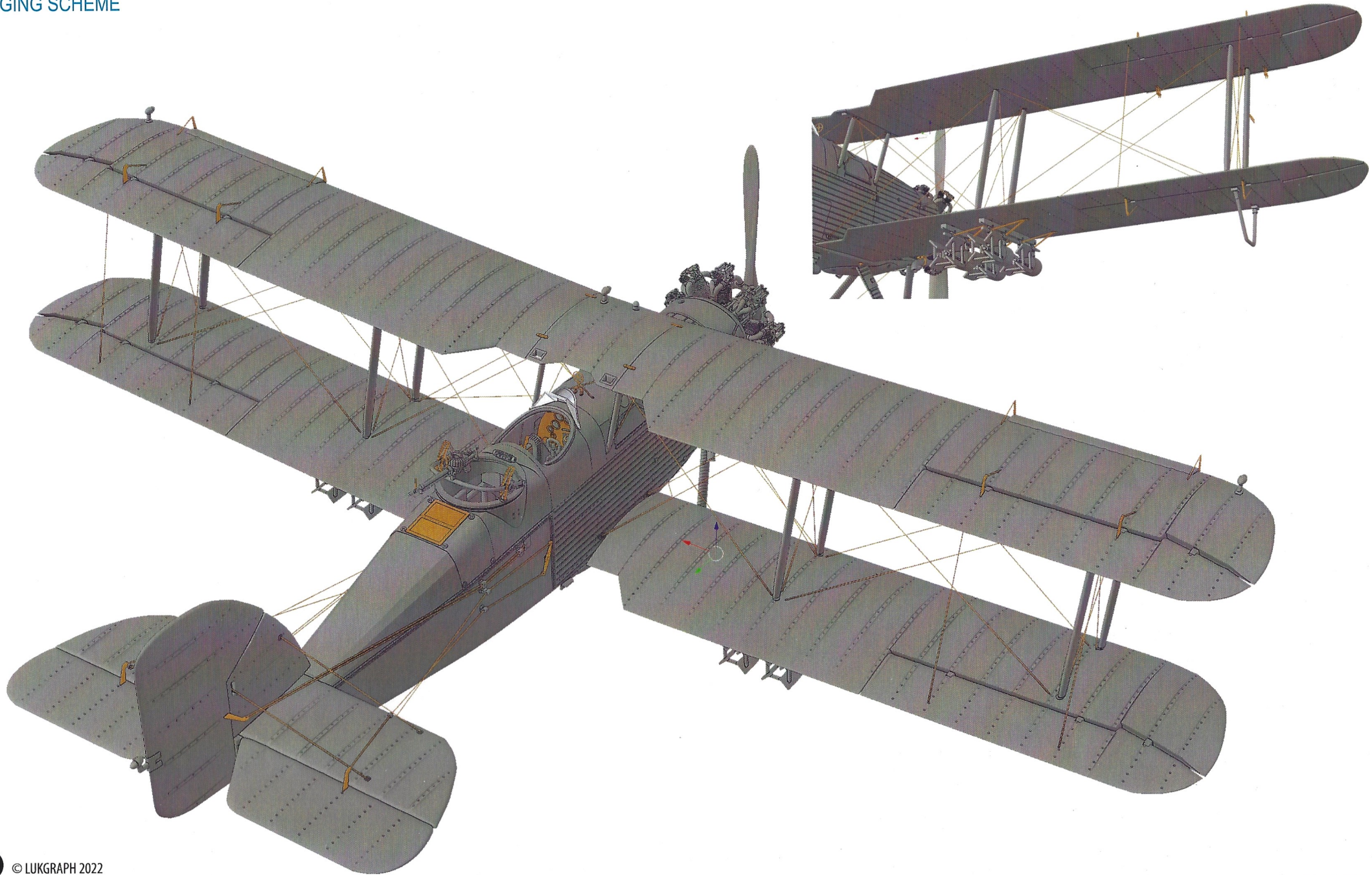

RIGGING SCHEME



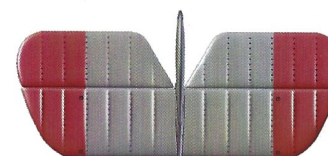
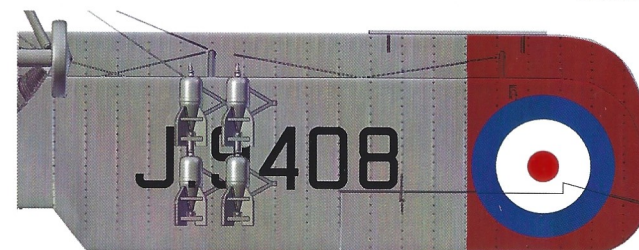
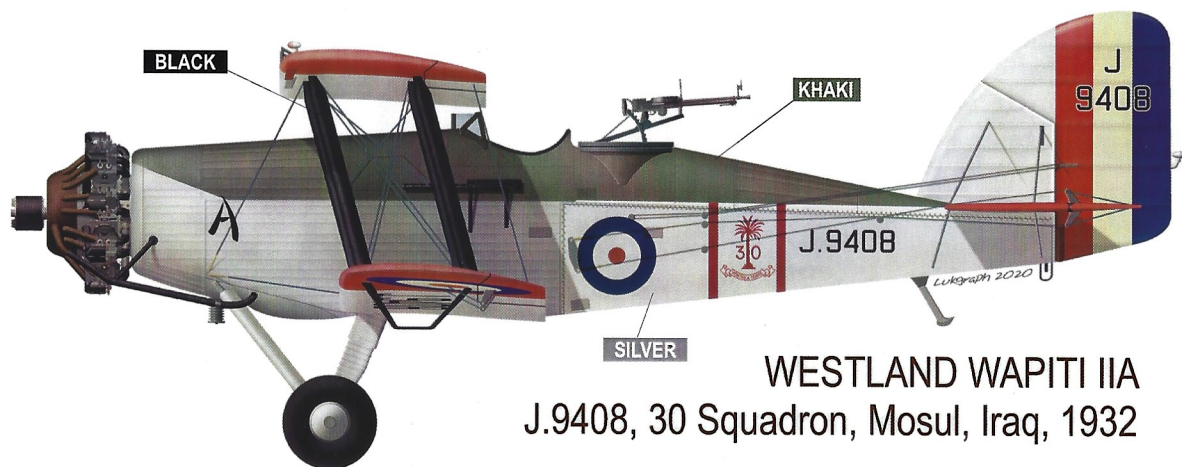

*painting the tailplane
from the bottom red color by analogy*

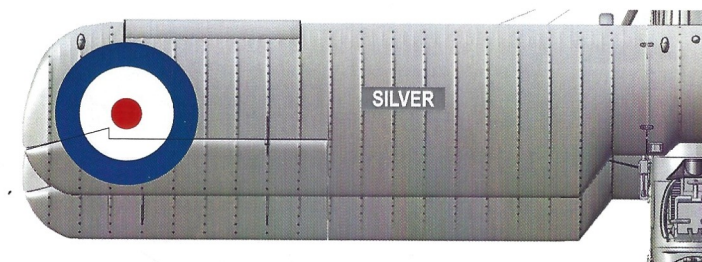

Wheel cover - red, blue or silver

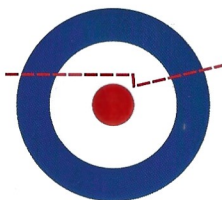

Cutting decals on the aileron