

Revell

Clipper Ship CUTTY SARK

5401-0089

© 1987 BY REVELL, INC.

PRINTED IN W. GERMANY



CEMENT
KLEBSTOFF
COLLE
PLASTIC LIJM
CEMENT
CEMENTO (COLLANTE)

DO NOT CEMENT
NICHT KLEBEN
NE PAS COLLER
NIET PLAKKEN
SKALL INTE KLISTHAS
NON IMCOLLARE

DO IT THIS MANY TIMES
ANZAHL DER ARBEITSGÄNGE
LE FAIRE CE NOMBRE DE FOIS
DOE HET ZOVEEL KEER
GJOR DET SA MANGE GÅNGER
FATELO TUTTE QUESTE VOLTE

OPTIONAL
WANLWIJSE
FACULTATIF
NAAR KEUZE
VALFRI
FACOLTATIVO

SOAK AND APPLY DECAL.
ABZIEHBILD IN WASSER EINWEICHEN UND ANBRINGEN.
MOUILLER ET APPLIQUER DECAL COMME.
MAAK PLAAKPLAATJE DOOR EN DOOR NAT EN BEVESTIG HET.
BLÖT LÅG MÅRKET OCH SÄTT PÅ DET.
IMMERGERE NELL ACQUA E APPLICARE CALCOMANIA.

 50% WHITE (BLACK) ONLY MITT WEISS (SCHWARZ) SEULEMENT BLANC (NOIR) WIT (ZWART) ALLEEN AZZURRO (NERO) BLENK + GLANS MET WIT (ZWART) OP BLANK MIT WEISS (SCHWARZ) AUF WEISS (SCHWARZ) CONCORSO (CONCORSO) BLANK	 50% WHITE (BLACK) ONLY MITT WEISS (SCHWARZ) SEULEMENT BLANC (NOIR) WIT (ZWART) ALLEEN AZZURRO (NERO) BLENK + GLANS MET WIT (ZWART) OP BLANK MIT WEISS (SCHWARZ) AUF WEISS (SCHWARZ) CONCORSO (CONCORSO) BLANK	 50% WHITE (BLACK) ONLY MITT WEISS (SCHWARZ) SEULEMENT BLANC (NOIR) WIT (ZWART) ALLEEN AZZURRO (NERO) BLENK + GLANS MET WIT (ZWART) OP BLANK MIT WEISS (SCHWARZ) AUF WEISS (SCHWARZ) CONCORSO (CONCORSO) BLANK	 50% WHITE (BLACK) ONLY MITT WEISS (SCHWARZ) SEULEMENT BLANC (NOIR) WIT (ZWART) ALLEEN AZZURRO (NERO) BLENK + GLANS MET WIT (ZWART) OP BLANK MIT WEISS (SCHWARZ) AUF WEISS (SCHWARZ) CONCORSO (CONCORSO) BLANK	 50% WHITE (BLACK) ONLY MITT WEISS (SCHWARZ) SEULEMENT BLANC (NOIR) WIT (ZWART) ALLEEN AZZURRO (NERO) BLENK + GLANS MET WIT (ZWART) OP BLANK MIT WEISS (SCHWARZ) AUF WEISS (SCHWARZ) CONCORSO (CONCORSO) BLANK	 50% WHITE (BLACK) ONLY MITT WEISS (SCHWARZ) SEULEMENT BLANC (NOIR) WIT (ZWART) ALLEEN AZZURRO (NERO) BLENK + GLANS MET WIT (ZWART) OP BLANK MIT WEISS (SCHWARZ) AUF WEISS (SCHWARZ) CONCORSO (CONCORSO) BLANK	 50% WHITE (BLACK) ONLY MITT WEISS (SCHWARZ) SEULEMENT BLANC (NOIR) WIT (ZWART) ALLEEN AZZURRO (NERO) BLENK + GLANS MET WIT (ZWART) OP BLANK MIT WEISS (SCHWARZ) AUF WEISS (SCHWARZ) CONCORSO (CONCORSO) BLANK	 50% WHITE (BLACK) ONLY MITT WEISS (SCHWARZ) SEULEMENT BLANC (NOIR) WIT (ZWART) ALLEEN AZZURRO (NERO) BLENK + GLANS MET WIT (ZWART) OP BLANK MIT WEISS (SCHWARZ) AUF WEISS (SCHWARZ) CONCORSO (CONCORSO) BLANK	 50% WHITE (BLACK) ONLY MITT WEISS (SCHWARZ) SEULEMENT BLANC (NOIR) WIT (ZWART) ALLEEN AZZURRO (NERO) BLENK + GLANS MET WIT (ZWART) OP BLANK MIT WEISS (SCHWARZ) AUF WEISS (SCHWARZ) CONCORSO (CONCORSO) BLANK	 50% WHITE (BLACK) ONLY MITT WEISS (SCHWARZ) SEULEMENT BLANC (NOIR) WIT (ZWART) ALLEEN AZZURRO (NERO) BLENK + GLANS MET WIT (ZWART) OP BLANK MIT WEISS (SCHWARZ) AUF WEISS (SCHWARZ) CONCORSO (CONCORSO) BLANK
--	--	--	--	--	--	--	--	--	--

 50% WHITE (BLACK) ONLY MITT WEISS (SCHWARZ) SEULEMENT BLANC (NOIR) WIT (ZWART) ALLEEN AZZURRO (NERO) BLENK + GLANS MET WIT (ZWART) OP BLANK MIT WEISS (SCHWARZ) AUF WEISS (SCHWARZ) CONCORSO (CONCORSO) BLANK	 50% WHITE (BLACK) ONLY MITT WEISS (SCHWARZ) SEULEMENT BLANC (NOIR) WIT (ZWART) ALLEEN AZZURRO (NERO) BLENK + GLANS MET WIT (ZWART) OP BLANK MIT WEISS (SCHWARZ) AUF WEISS (SCHWARZ) CONCORSO (CONCORSO) BLANK	 50% WHITE (BLACK) ONLY MITT WEISS (SCHWARZ) SEULEMENT BLANC (NOIR) WIT (ZWART) ALLEEN AZZURRO (NERO) BLENK + GLANS MET WIT (ZWART) OP BLANK MIT WEISS (SCHWARZ) AUF WEISS (SCHWARZ) CONCORSO (CONCORSO) BLANK
--	--	--

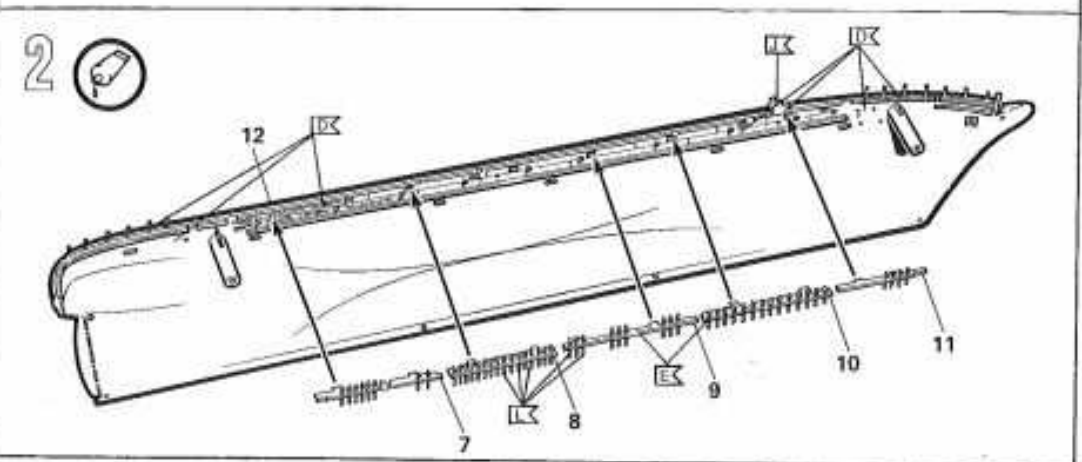
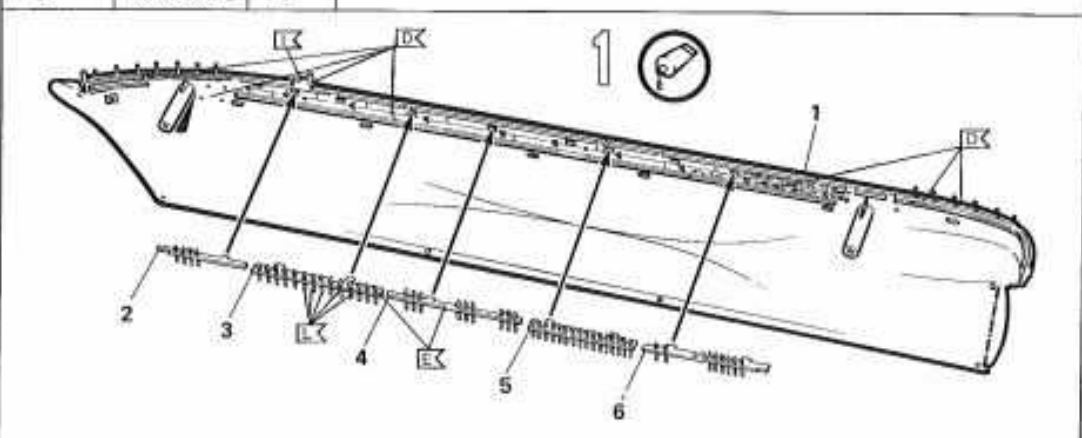

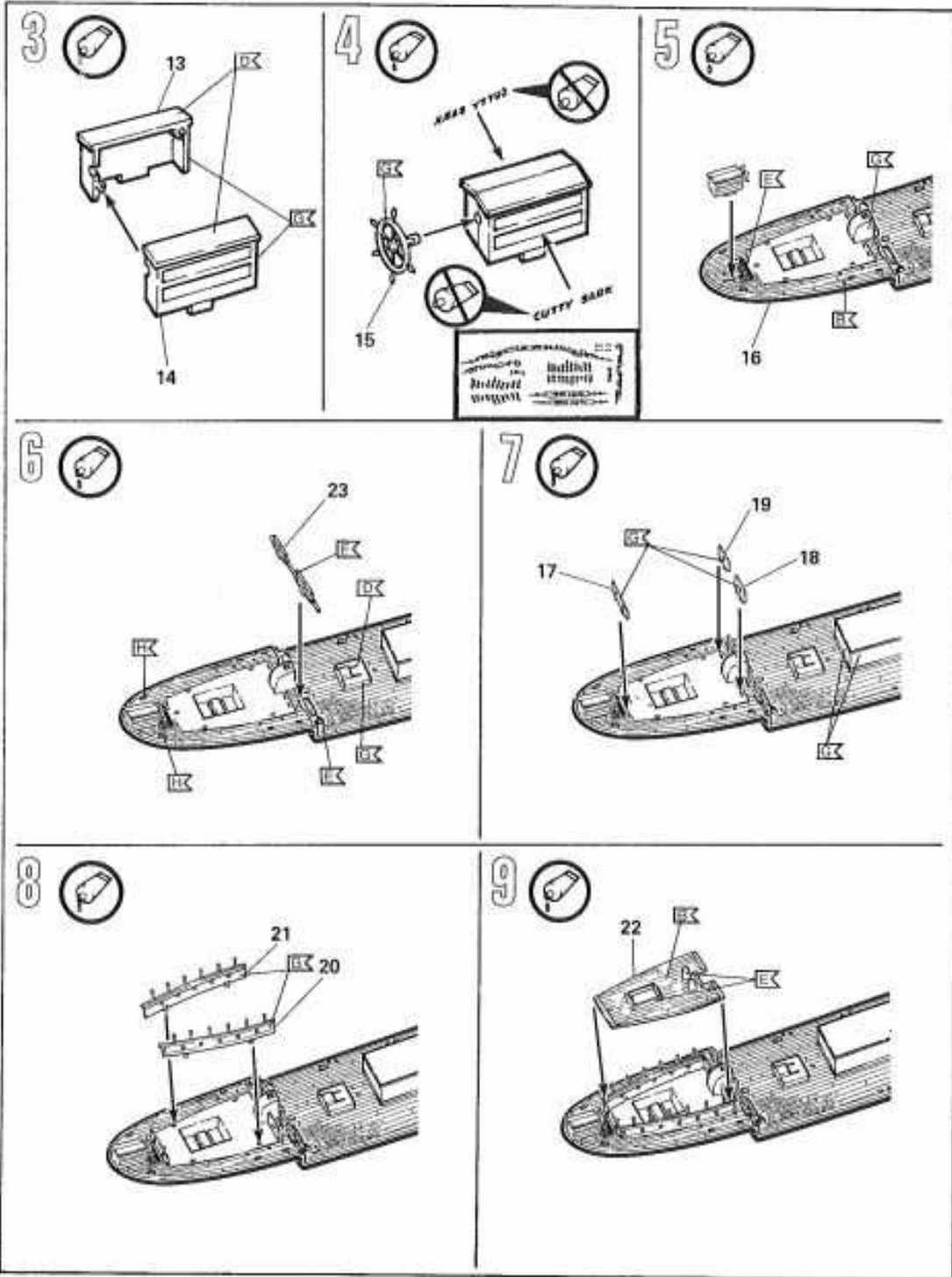

10

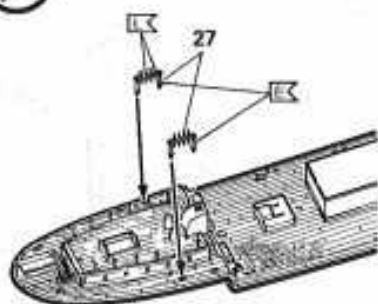

11

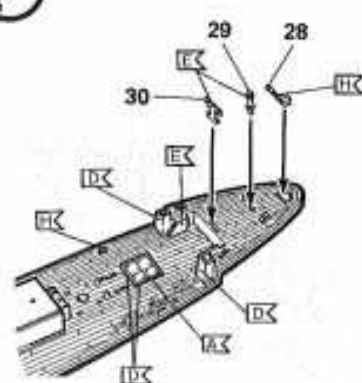

12



2X

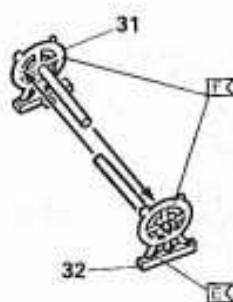

13

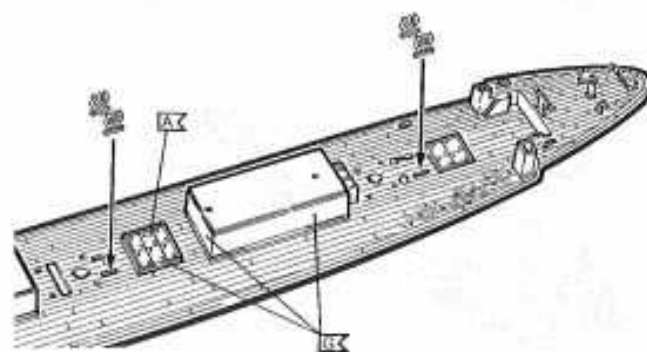

14

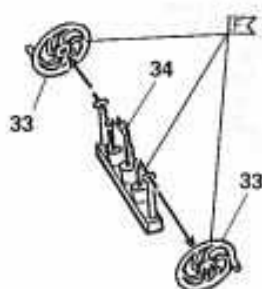

15

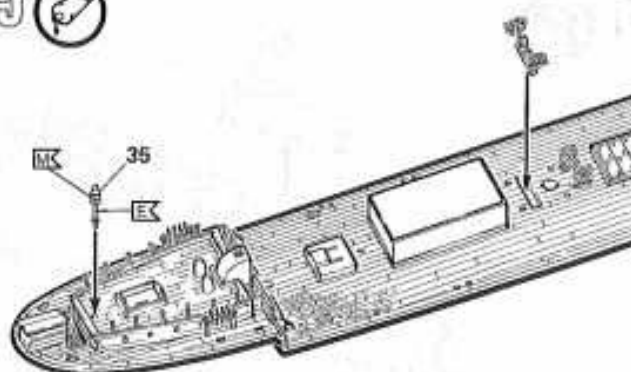

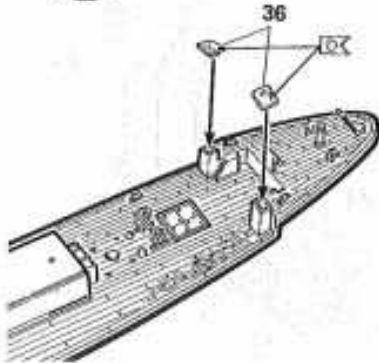
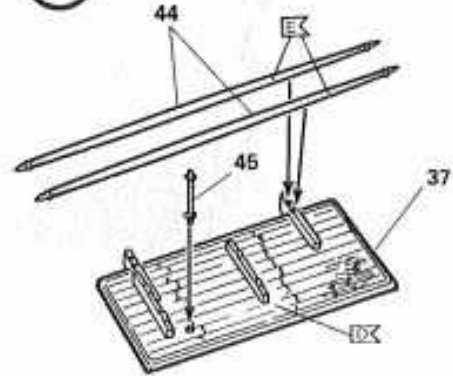
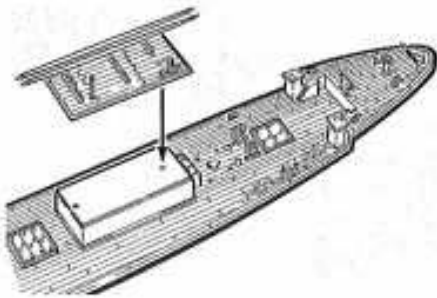
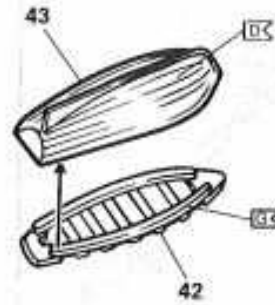
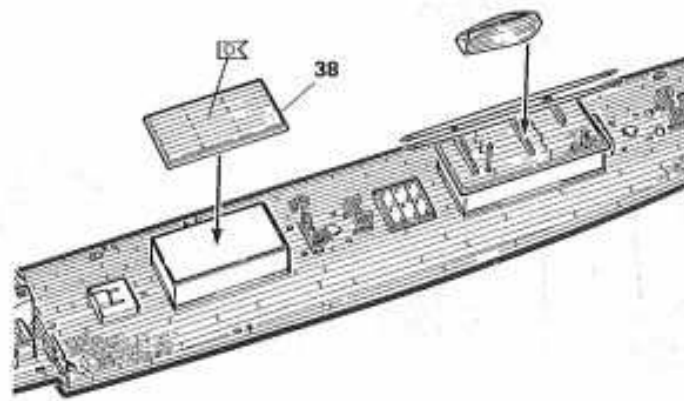
16 17 18 19 20 

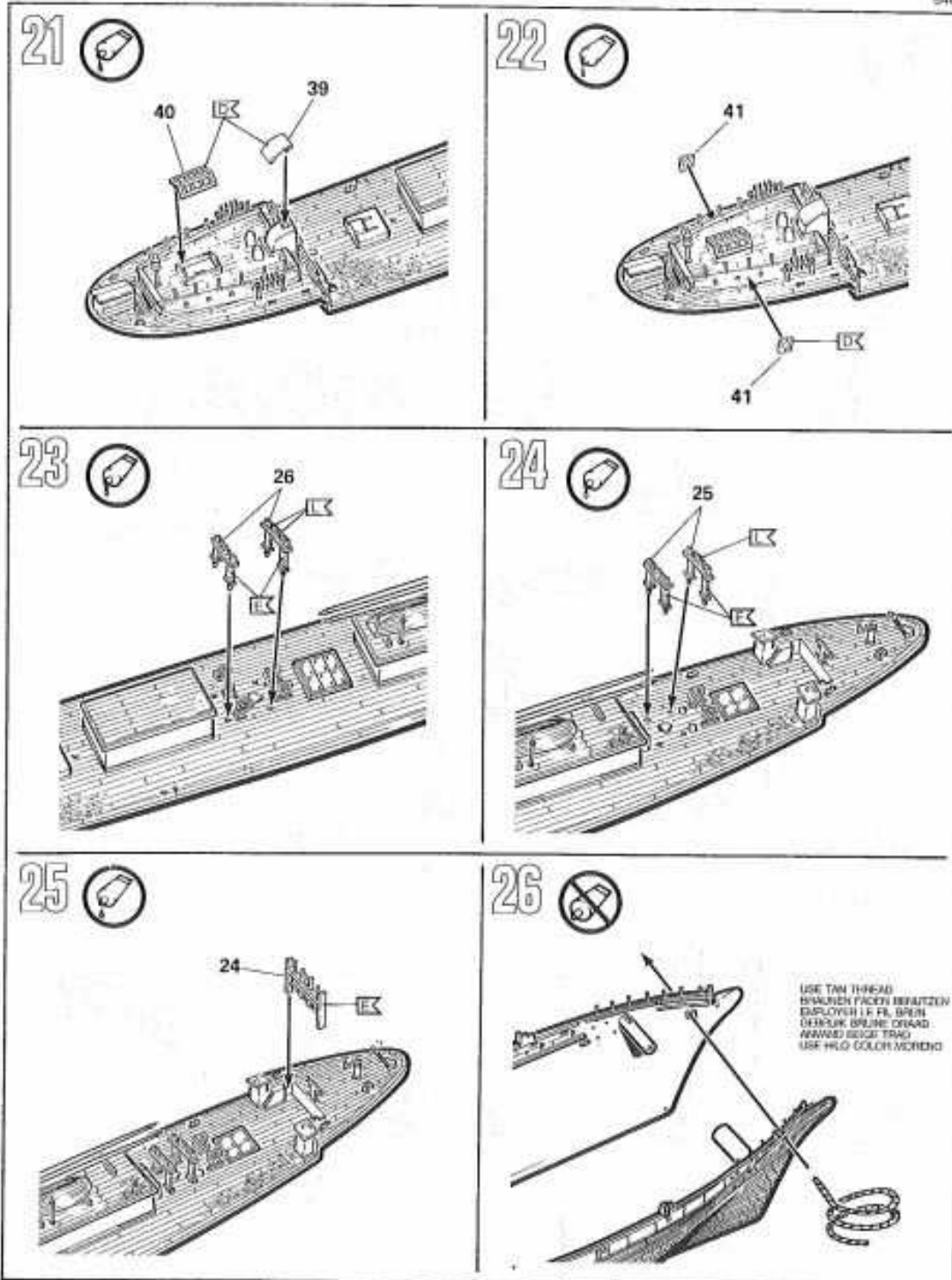

27 

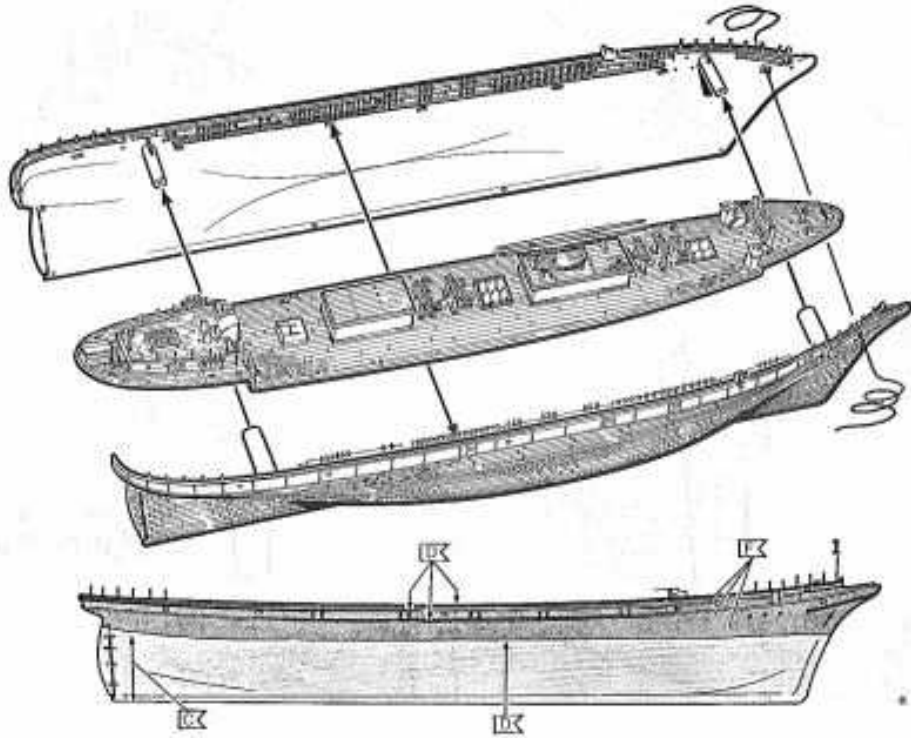

28 

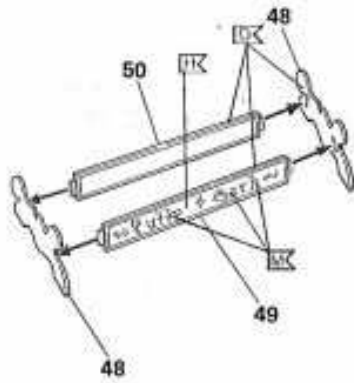

29 

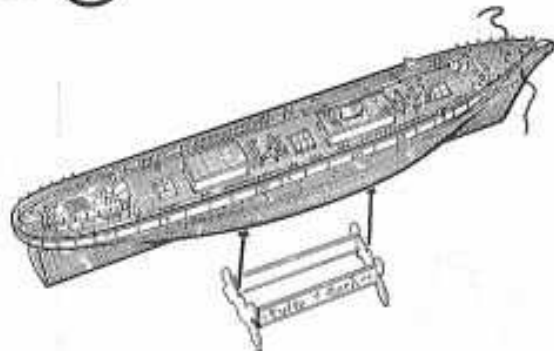

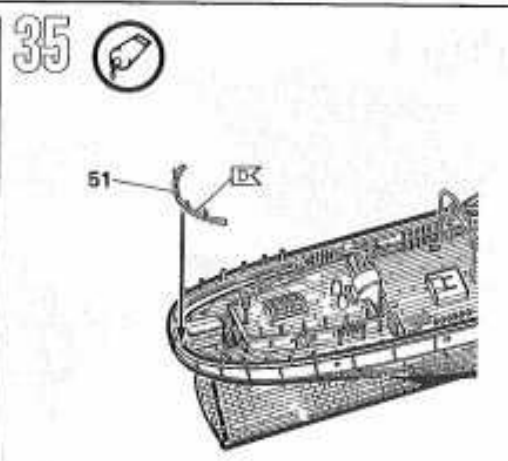
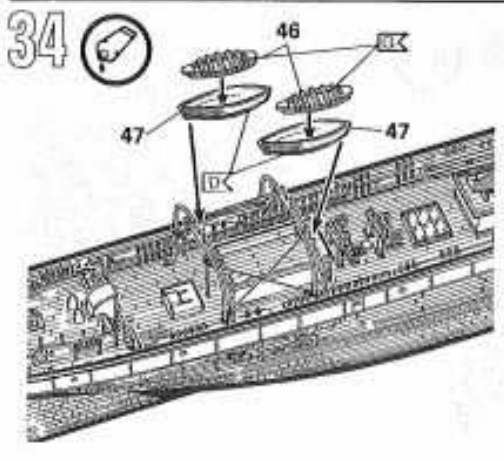
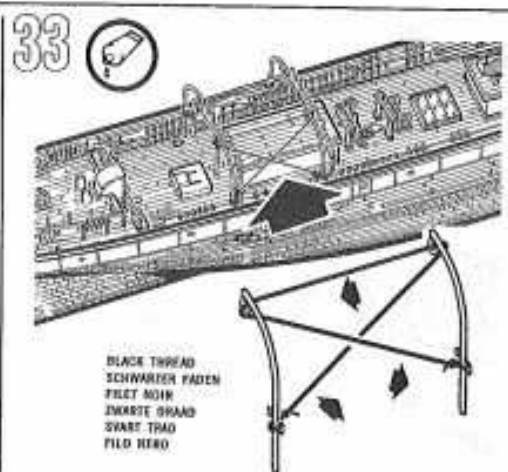
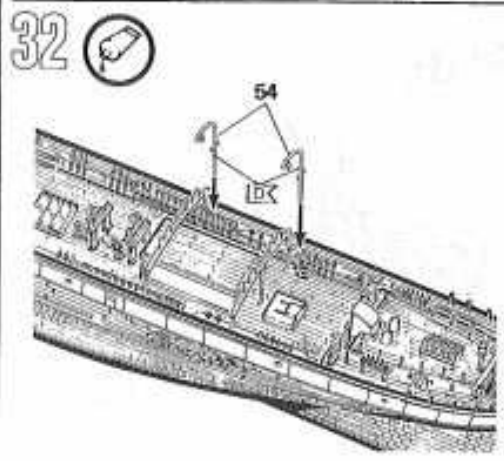
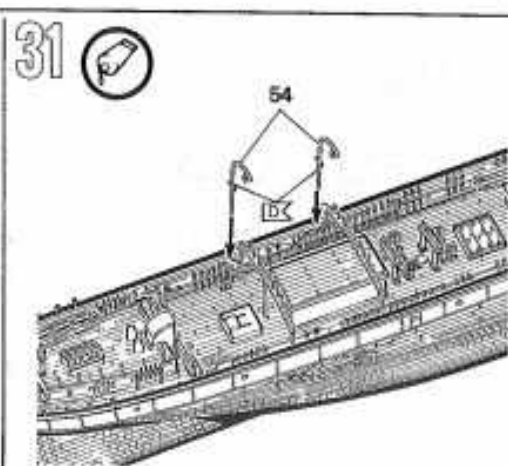
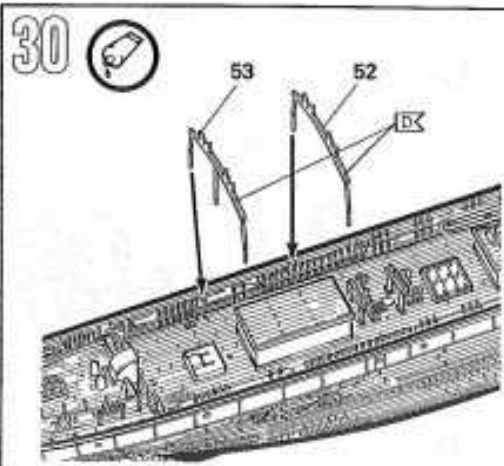

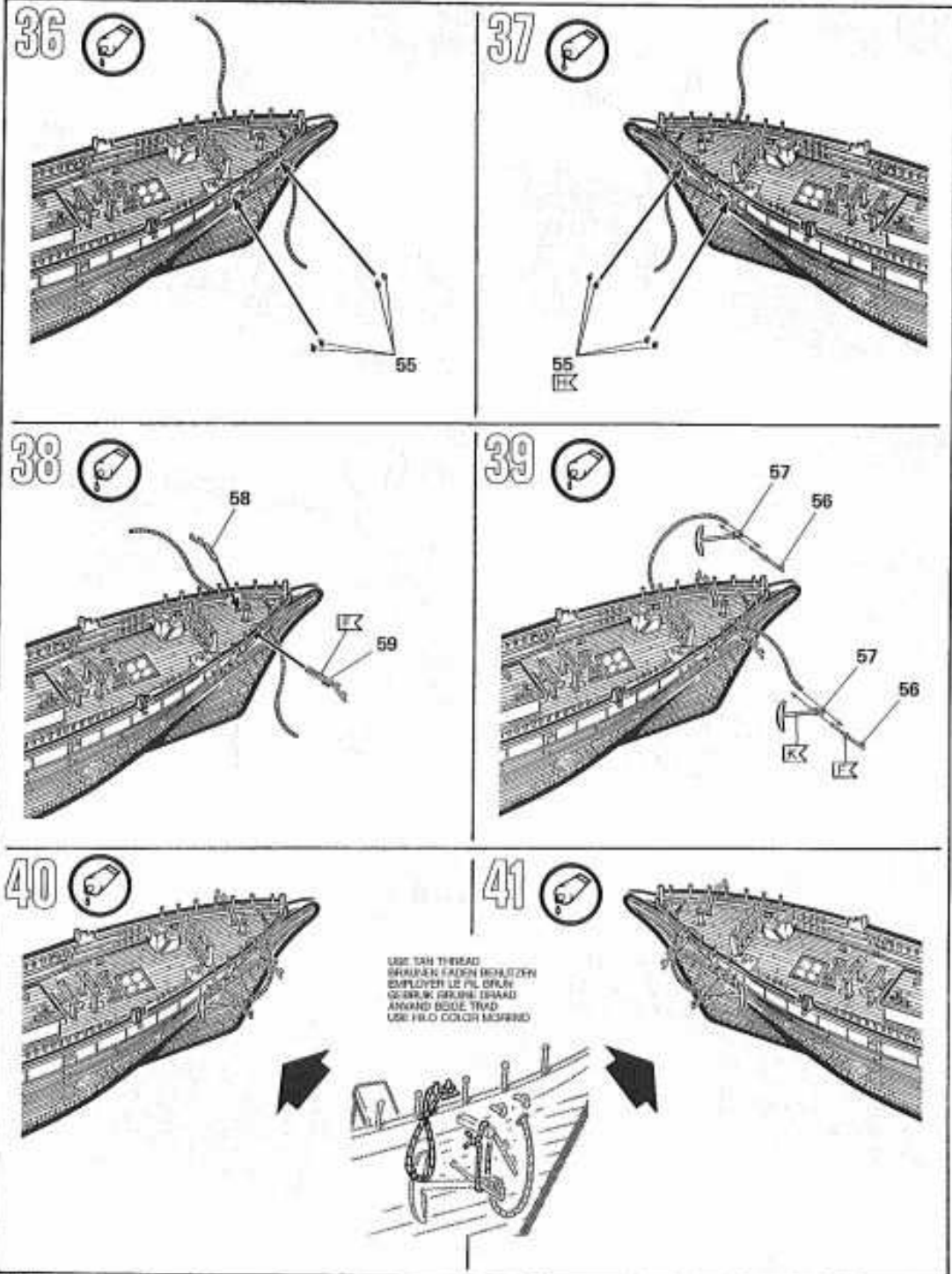

42 

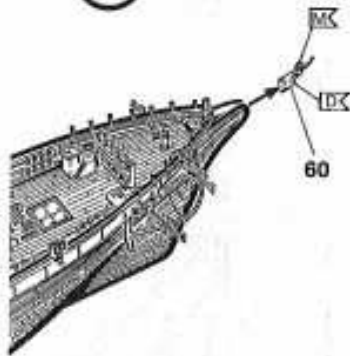

43 

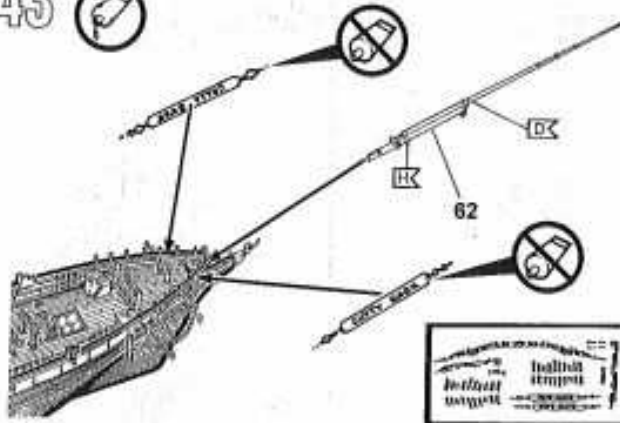

WARNING
Do not use the tool on the hull or deck.
Use the correct tool for the job.
Do not use the tool on the hull or deck.

44 

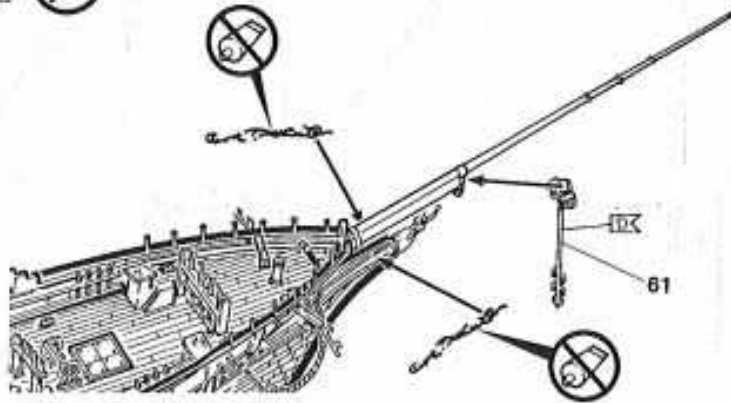

WARNING
Do not use the tool on the hull or deck.
Use the correct tool for the job.
Do not use the tool on the hull or deck.

45 

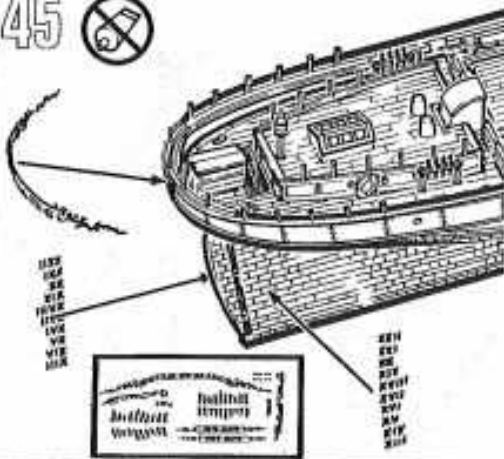

WARNING
Do not use the tool on the hull or deck.
Use the correct tool for the job.
Do not use the tool on the hull or deck.

DO NOT USE THE TOOL ON THE HULL OR DECK

46 

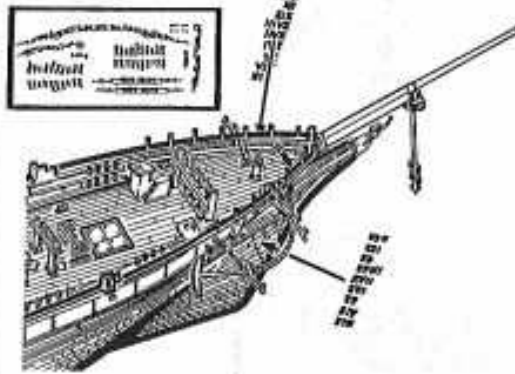

WARNING
Do not use the tool on the hull or deck.
Use the correct tool for the job.
Do not use the tool on the hull or deck.

DO NOT USE THE TOOL ON THE HULL OR DECK

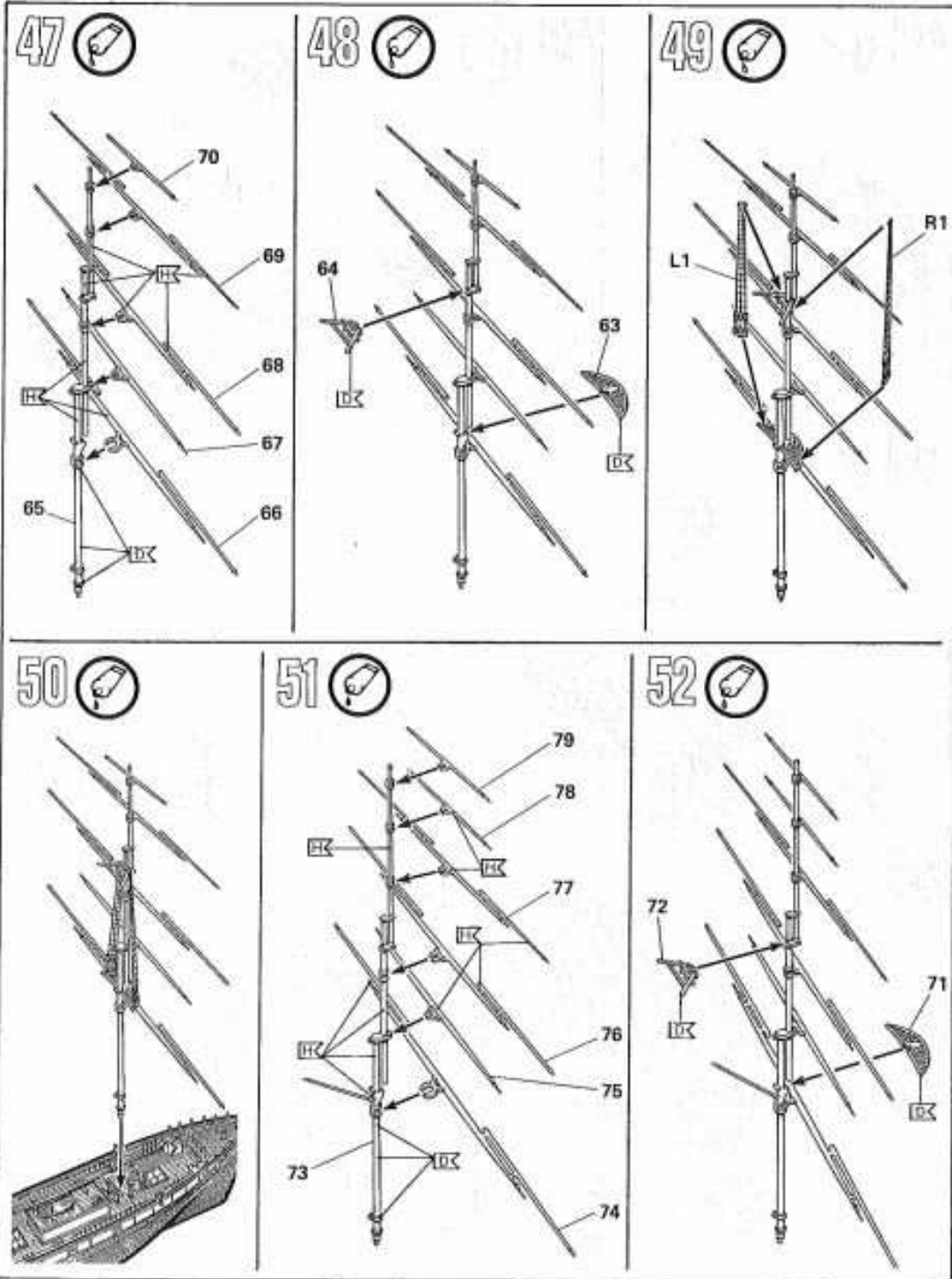

53 

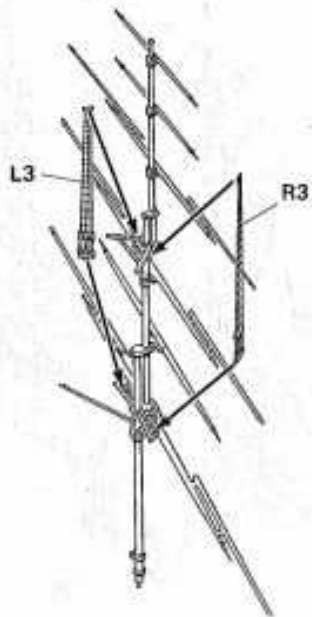

54 

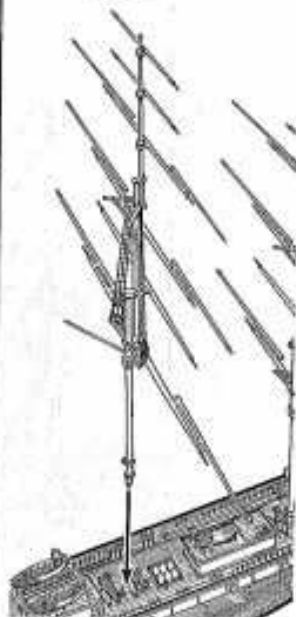

55 

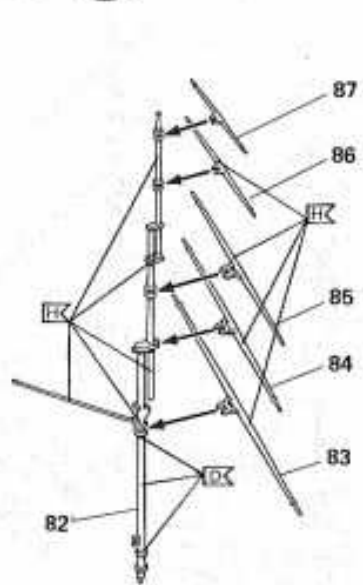

56 

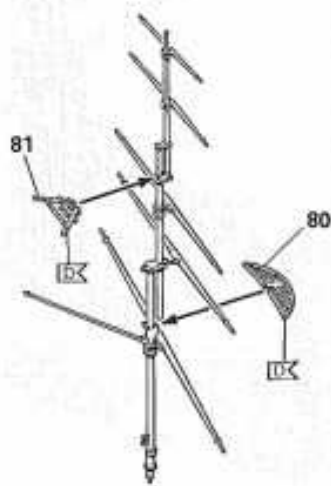

57 

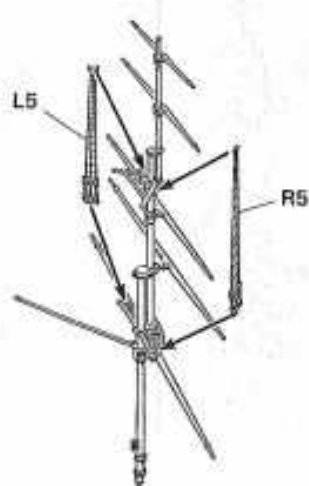

58 

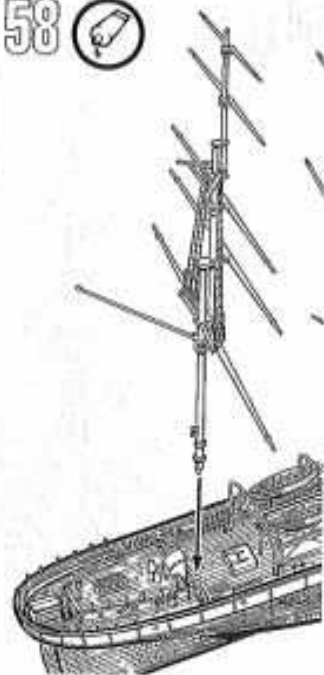

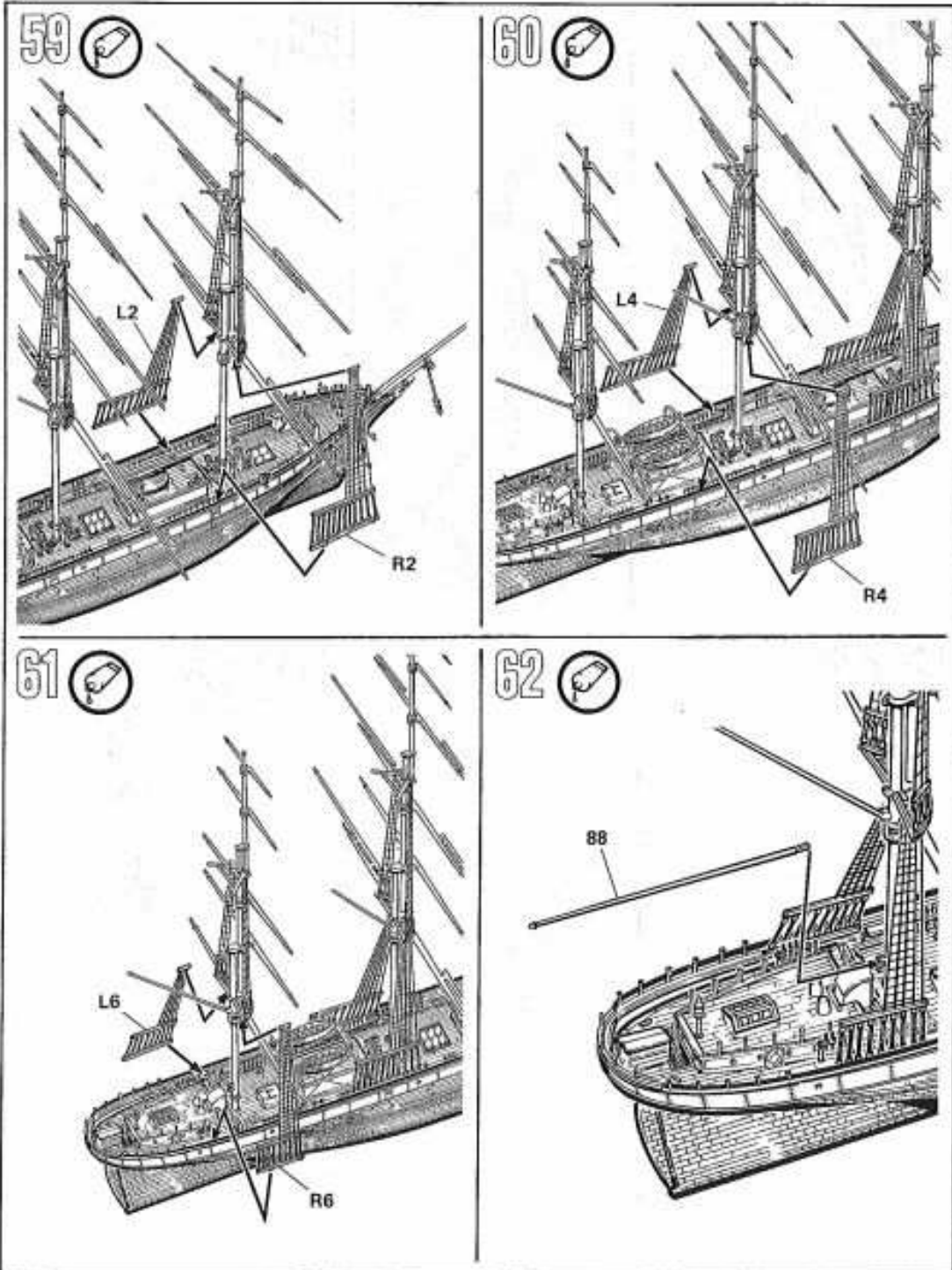

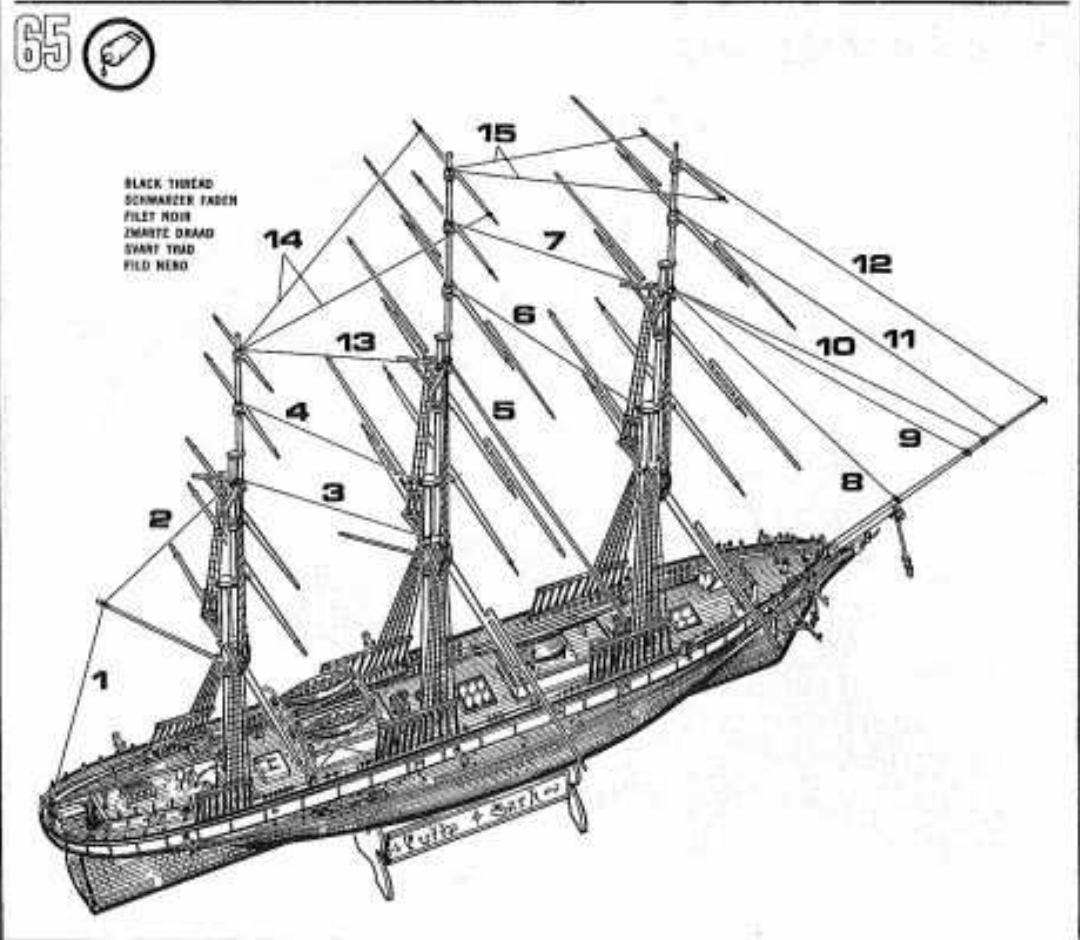
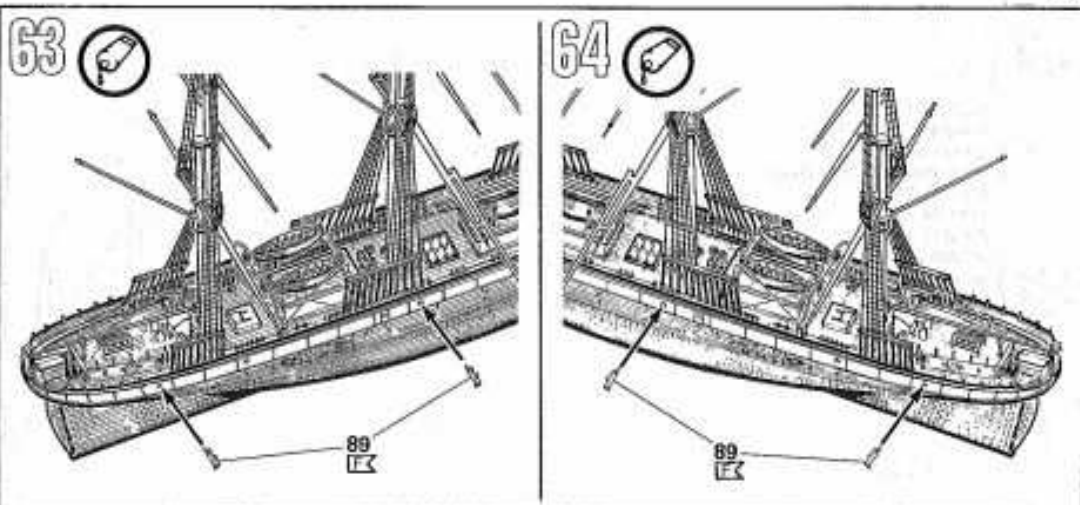

66 ?

A

Simplified rigging
vereinfachte Takelage
gréage simplifié
véereenvoudigde uitrusting
förenklad rigg
schema delle manovre

B

detailed rigging
detaillierte Takelage
gréage détaillé
Gedetailleerde uitrusting
detaljerad rigg
sistemazione in dettaglio delle manovre

C

Running rigging
Tauwerk
gréage en cours
Tauw-werk
Tackel
manovre correnti

67 A



USE TAN THREAD
BRAUNEN FADEN BENUTZEN
EMPLOYER LE FIL BRUN
GEWIK BRUNE ORAAD
ANWIND BEGE TRAD
USE NILD COLOR MORENO

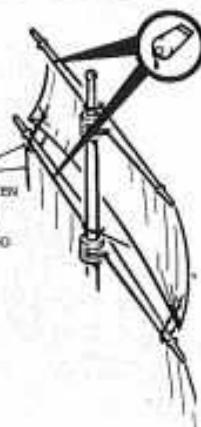
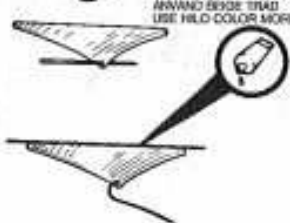

68

A

B

C

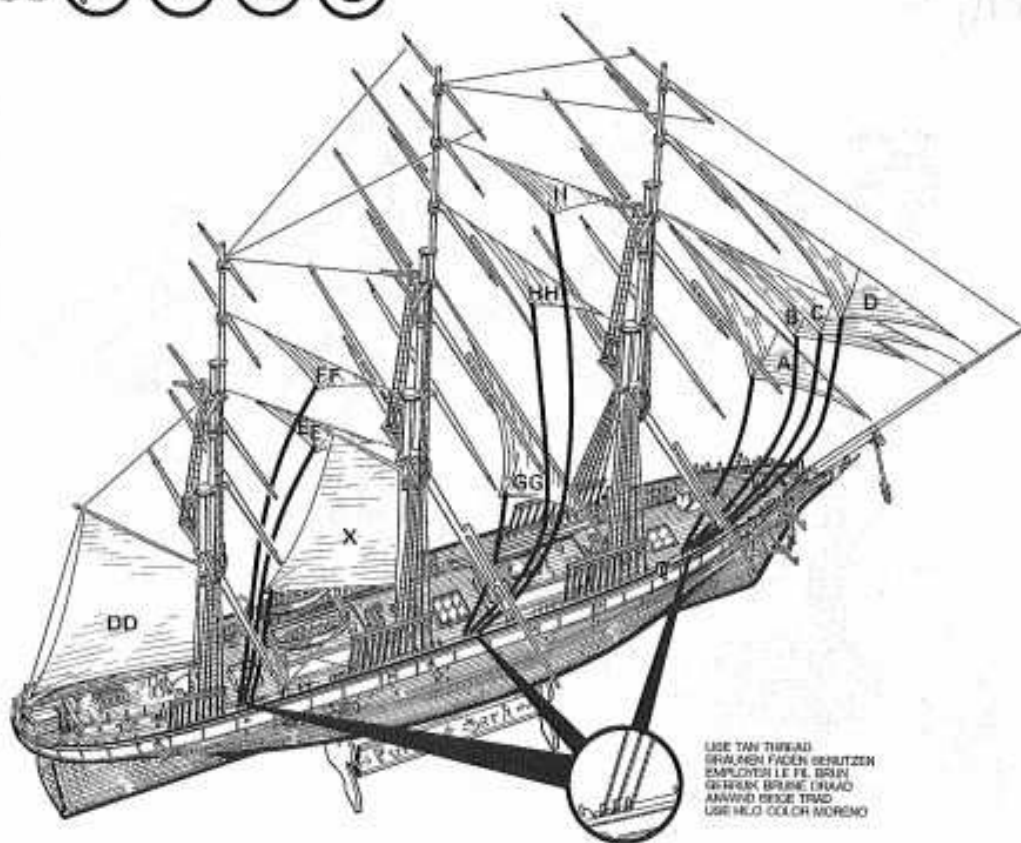

USE TAN THREAD
BRAUNEN FADEN BENUTZEN
EMPLOYER LE FIL BRUN
GEWIK BRUNE ORAAD
ANWIND BEGE TRAD
USE NILD COLOR MORENO

69  (A) (B)

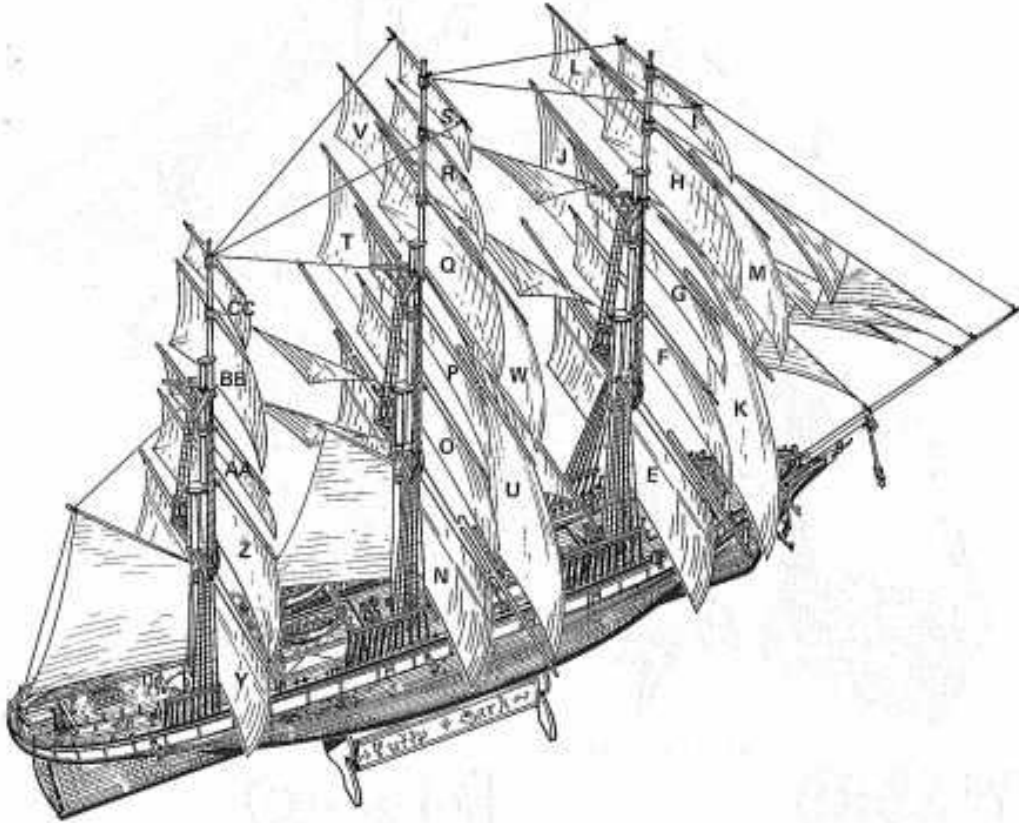

70 (C)

USE TAN THREAD
BRAUNEN FADEN BENUTZEN
D'AVOIRSI LE FIL BRUN
GEBRUIK BRUINE DRAAD
ANWAND BRUINE DRAAD
USE HILD GÖLDER NÖRND



TE AND GLOBE
ANWANDEN UND KLEBEN
ATTACHER ET GLOBE
KLEBEN EN LOUEN
HIND FASIT DICH KLEBEN
ANWAND Y FEGUE
LEBARE Y INCOLLARE

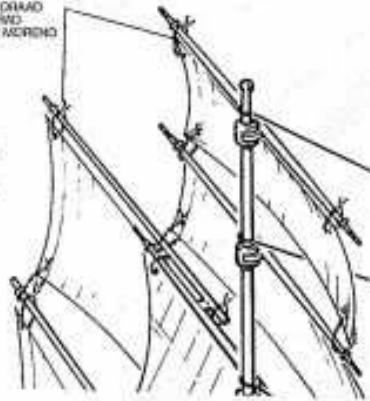

71  **(B)**

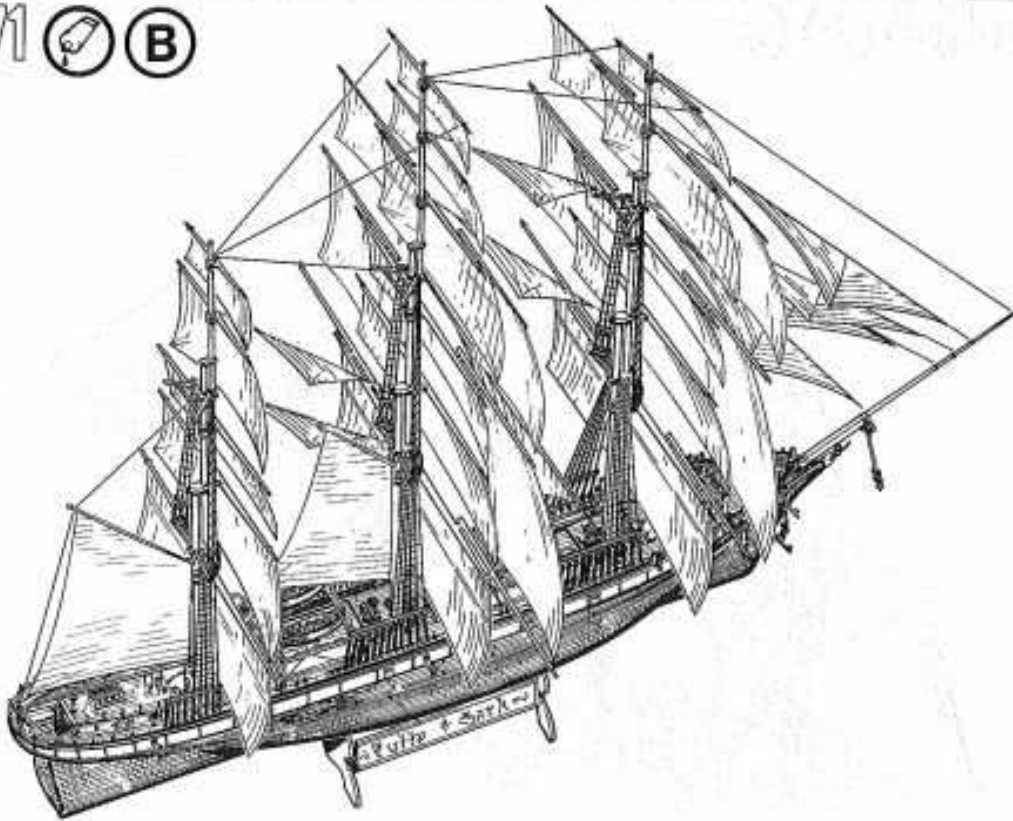

72  **(C)**

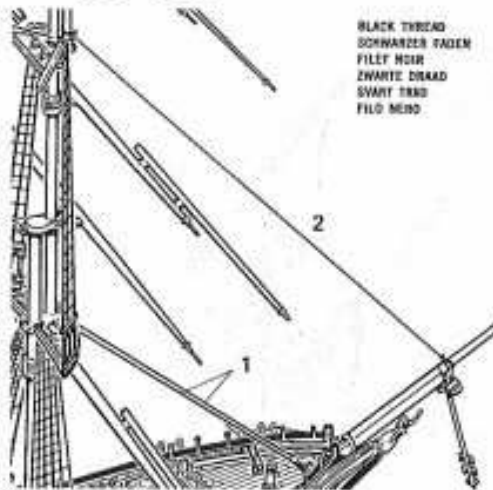

BLACK THREAD
SCHWARZE FADEN
FILET NOIR
ZWARTE DRAAD
SVART TRÅD
FILET NIRO

73  **(C)**

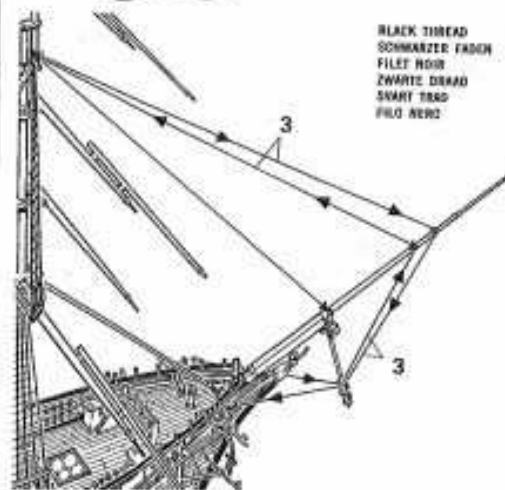

BLACK THREAD
SCHWARZE FADEN
FILET NOIR
ZWARTE DRAAD
SVART TRÅD
FILET NIRO

74



C

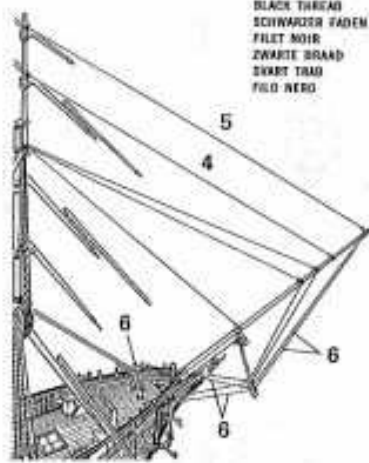

BLACK THREAD
SCHWARZER FADEN
FILET NOIR
ZWARTE DRAD
SWART TRAD
FILO NERO

75



C

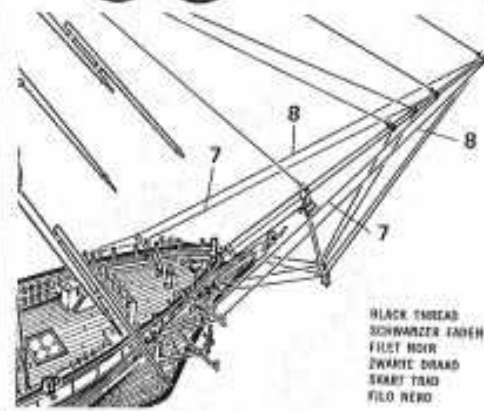

BLACK THREAD
SCHWARZER FADEN
FILET NOIR
ZWARTE DRAD
SWART TRAD
FILO NERO

76

C

BLACK THREAD
SCHWARZER FADEN
FILET NOIR
ZWARTE DRAD
SWART TRAD
FILO NERO

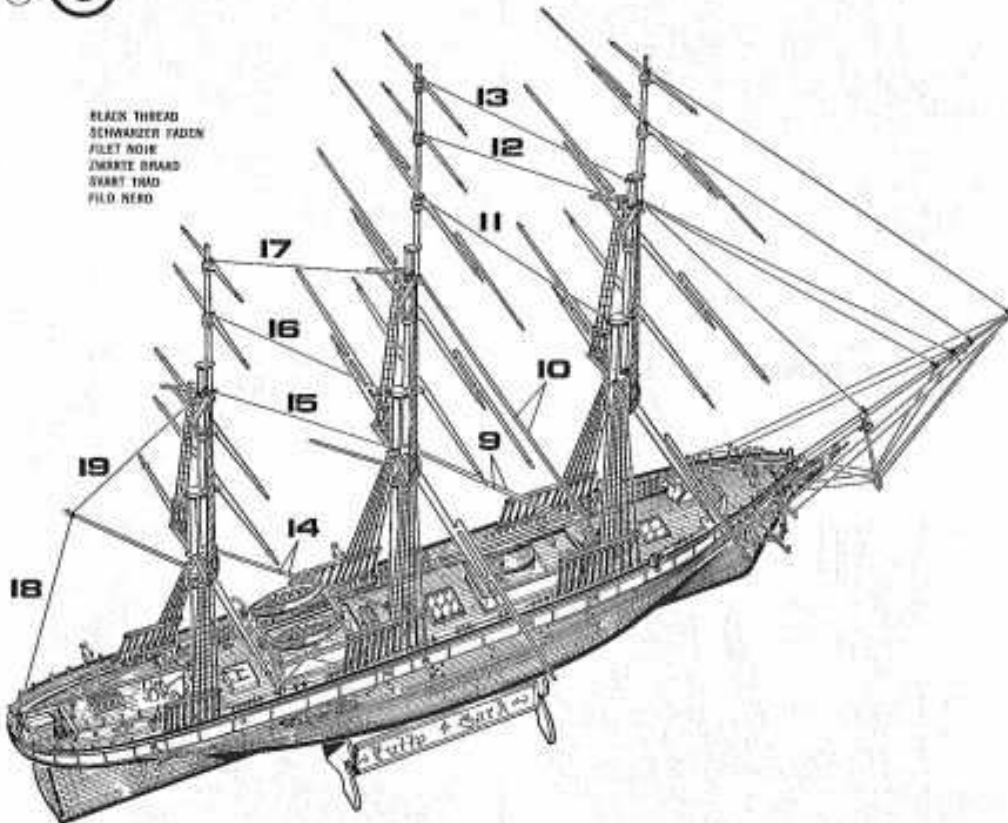

77  

BLACK THREAD
SCHWARZER FADEN
FILET NOIR
ZWARTE DRAAD
SVART TRÅD
FILO NERO

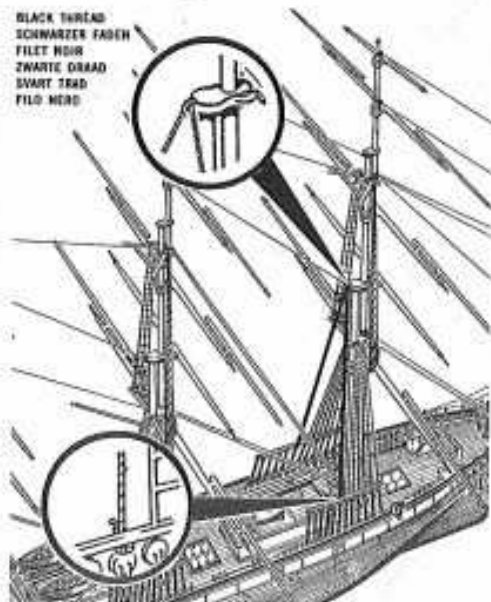
78  

BLACK THREAD
SCHWARZER FADEN
FILET NOIR
ZWARTE DRAAD
SVART TRÅD
FILO NERO

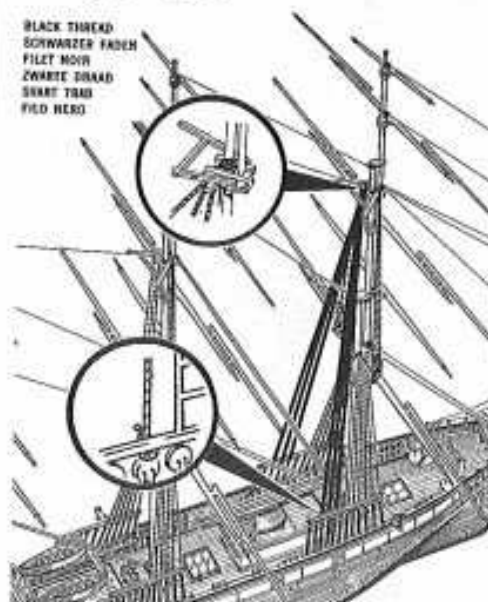
79  

BLACK THREAD
SCHWARZER FADEN
FILET NOIR
ZWARTE DRAAD
SVART TRÅD
FILO NERO

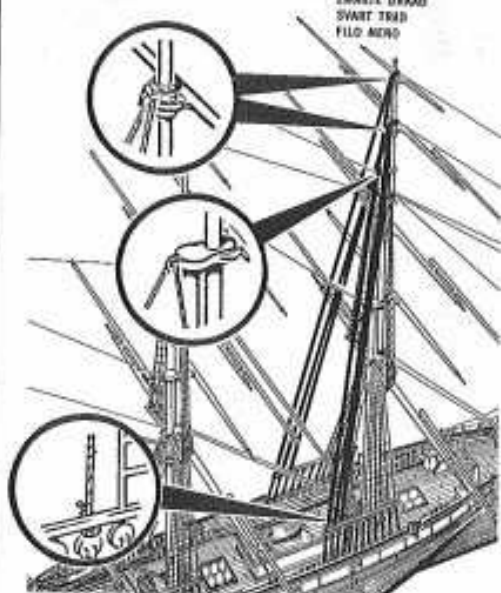
80  

BLACK THREAD
SCHWARZER FADEN
FILET NOIR
ZWARTE DRAAD
SVART TRÅD
FILO NERO

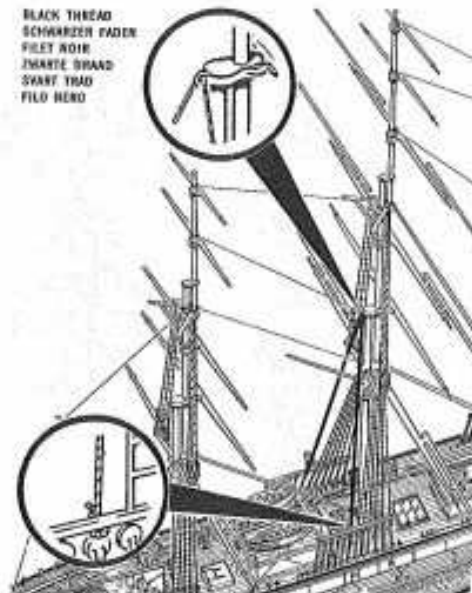

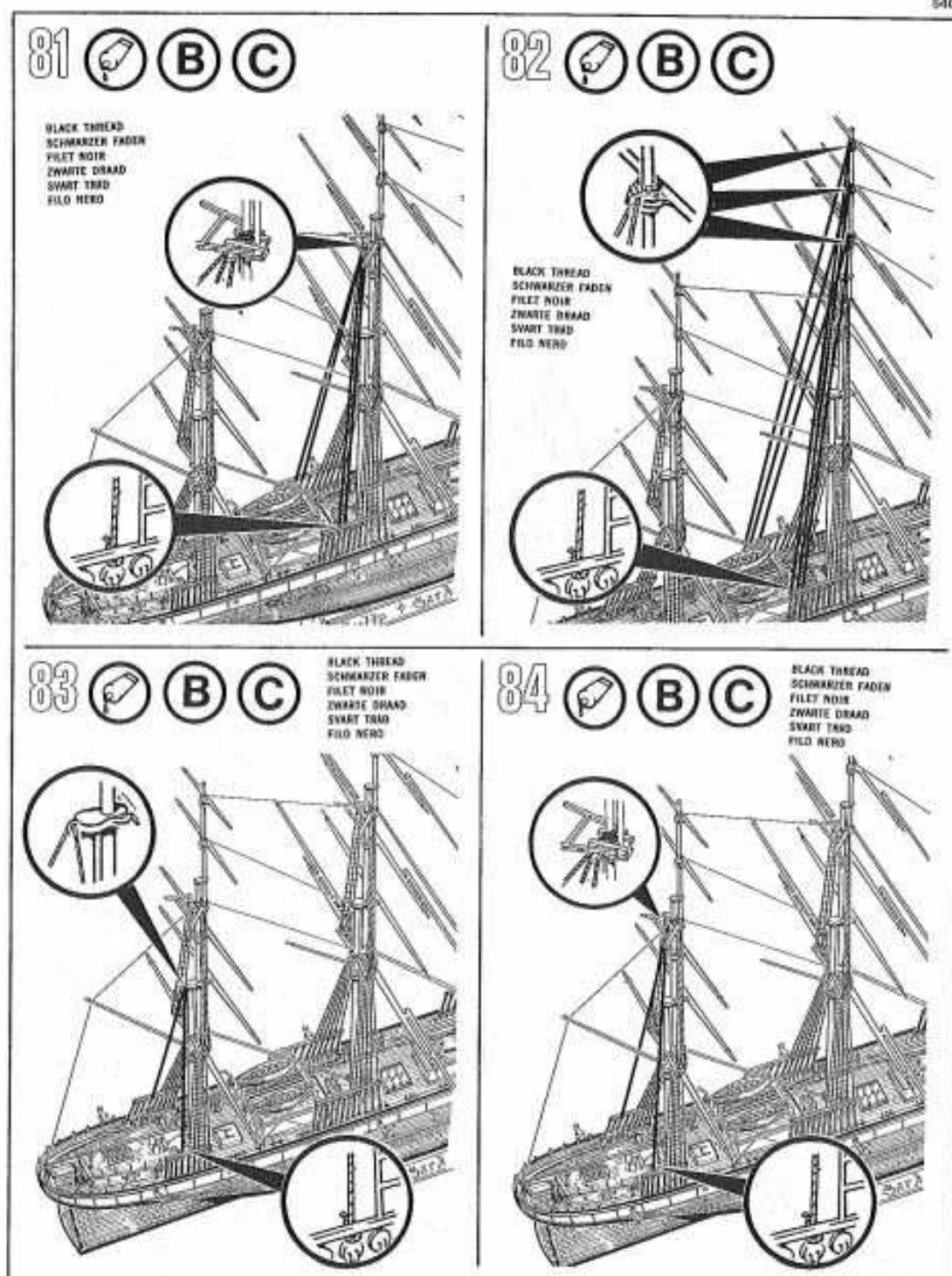

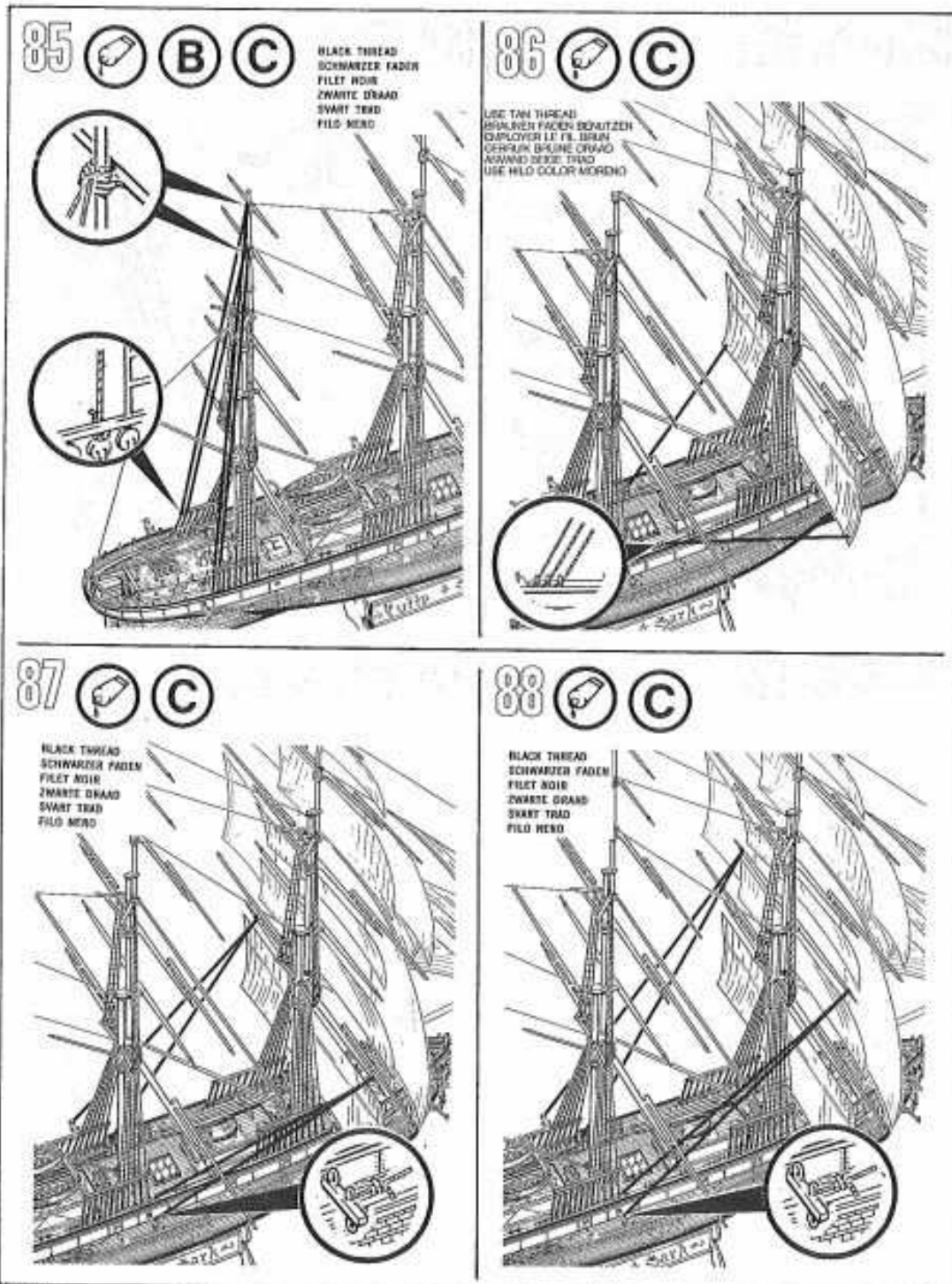

89  

BLACK THREAD
SCHWARZER FADEN
FILET NOIR
ZWARTE DRAAD
SWART TRAD
FILO NERO

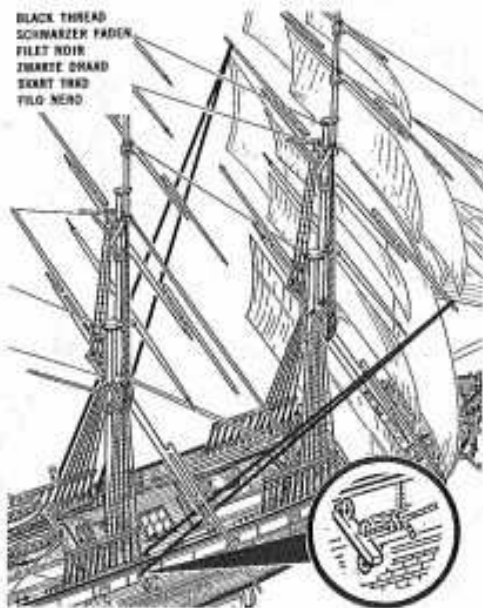

90  

BLACK THREAD
SCHWARZER FADEN
FILET NOIR
ZWARTE DRAAD
SWART TRAD
FILO NERO



91  

BLACK THREAD
SCHWARZER FADEN
FILET NOIR
ZWARTE DRAAD
SWART TRAD
FILO NERO

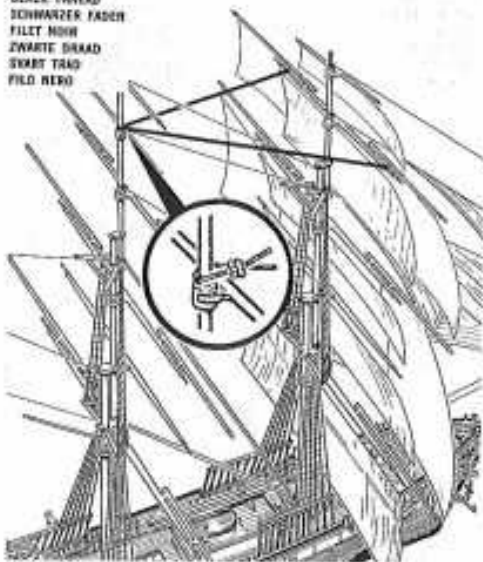

92  

BLACK THREAD
SCHWARZER FADEN
FILET NOIR
ZWARTE DRAAD
SWART TRAD
FILO NERO

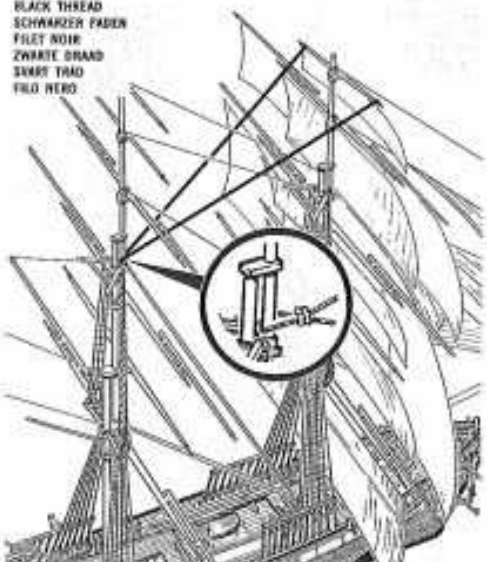

93  

USE TAN THREAD
 BRÄUNLICHEN FADEN BENUTZEN
 EMPLOYER LE FIL MARRON
 GEBRUIK BRUINE DRAAD
 AYWANG NINGE TRAU
 USE HILO COLOR MORENO

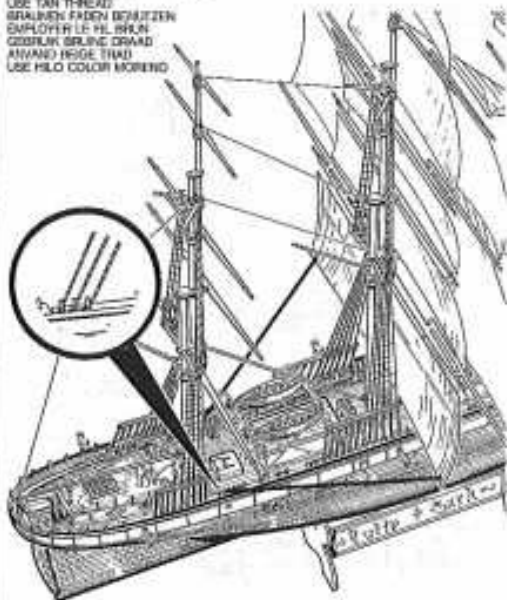
94  

BLACK THREAD
 SCHWARZER FADEN
 FILET NOIR
 ZWARTE DRAAD
 ZWART TRAD
 FILD NERO

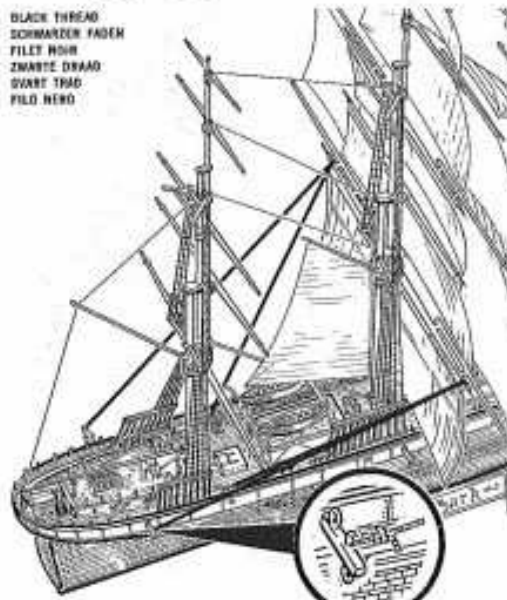
95  

BLACK THREAD
 SCHWARZER FADEN
 FILET NOIR
 ZWARTE DRAAD
 ZWART TRAD
 FILD NERO

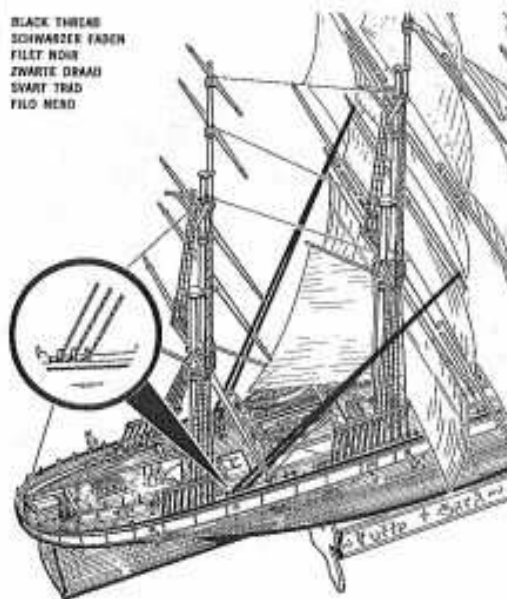
96  

BLACK THREAD
 SCHWARZER FADEN
 FILET NOIR
 ZWARTE DRAAD
 ZWART TRAD
 FILD NERO

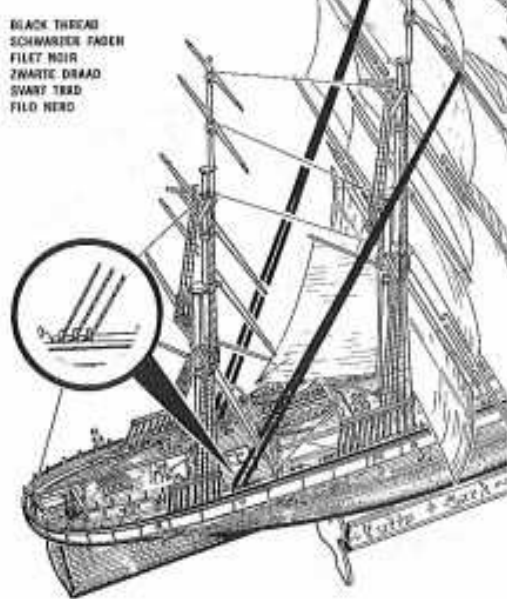

97  

BLACK THREAD
SCHWARZER FADEN
FILET NOIR
ZWARTE DRAAD
SWART TRAD
FILO NERO

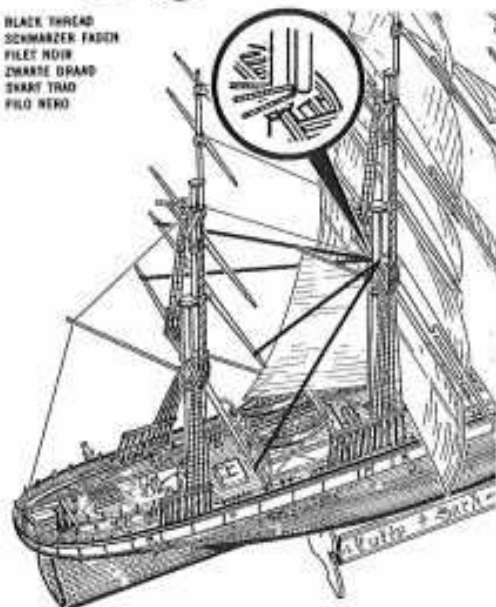
98  

BLACK THREAD
SCHWARZER FADEN
FILET NOIR
ZWARTE DRAAD
SWART TRAD
FILO NERO

99  

BLACK THREAD
SCHWARZER FADEN
FILET NOIR
ZWARTE DRAAD
SWART TRAD
FILO NERO

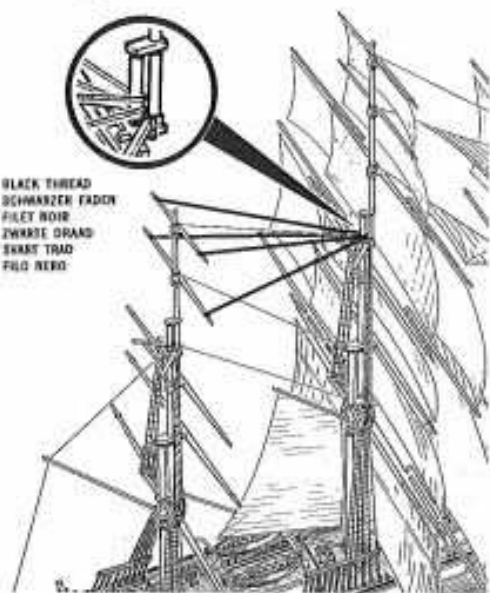
100  

BLACK THREAD
SCHWARZER FADEN
FILET NOIR
ZWARTE DRAAD
SWART TRAD
FILO NERO



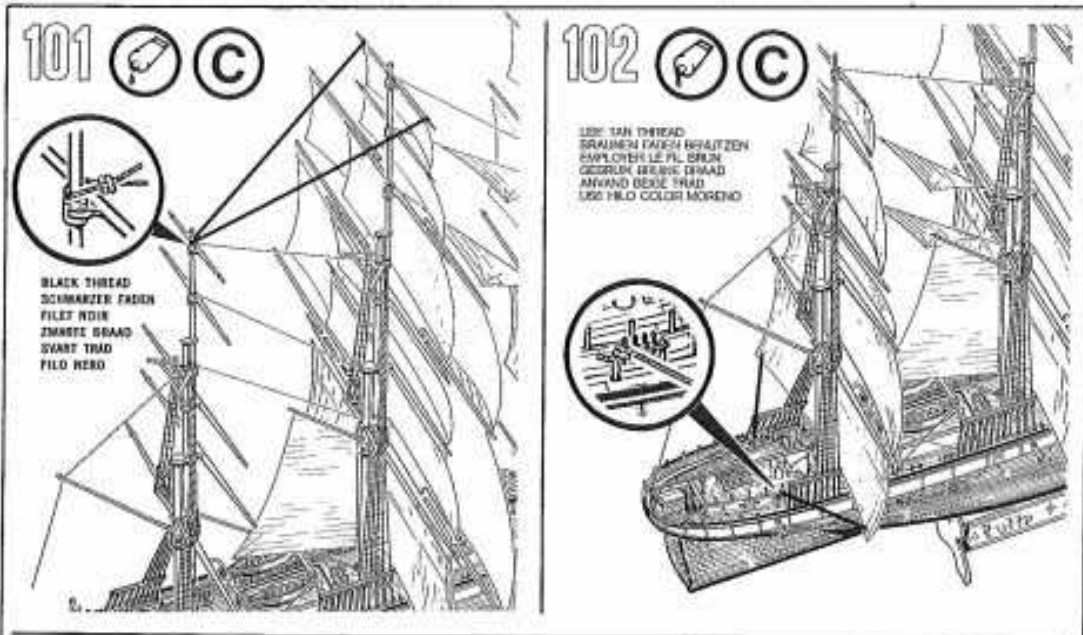

101



BLACK THREAD
SCHWARZER FADEN
FILET NOIR
ZWARTE GBAAD
SVART TRÅD
FILO NEGRO



102

USE TAN THREAD
BRAUNEN GADEN ERHALTEN
EMPLOYER LE FIL BRUN
GEBRUIK GEELDE GBAAD
ANWIND GELE TRAD
USO FILO COLORE MORENO

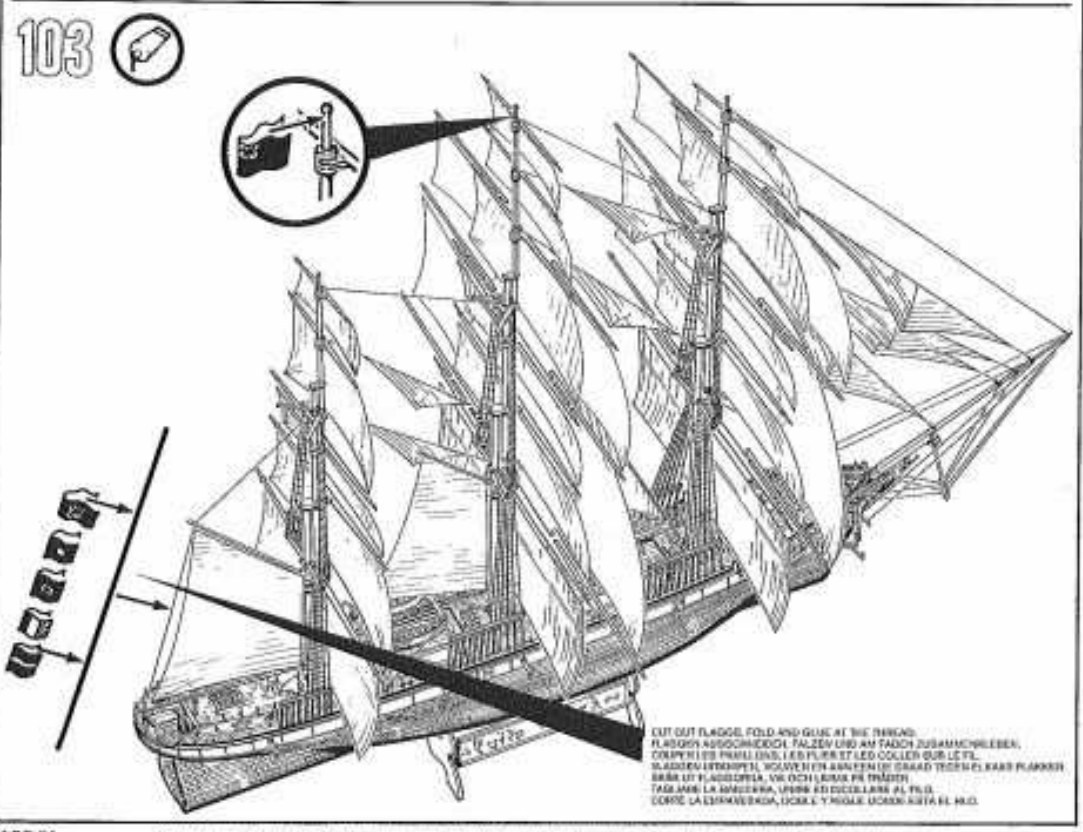

103



CUT OUT FLAGGE, FOLD AND GLUE AT THE RINGS.
FLAGGEN AUSSCHNEIDEN, FALZEN UND AM RINGEN ZUSAMMENLEBEN.
CUTTER LES PAVILONS, LES PLIÉS ET LES COLLÉS SUR LES RINGES.
BLAGGIVAN USTROPIVET, NOLIVAN IAN PAVILON TSIHAD TSIHAD IAN PAVILON.
SÅR LJÖ FLAGGET, VIK OCH LÄMNA PÅ RINGEN.
TAGG AV DEN FLAGGAN, VIK OCH LÄMNA PÅ RINGEN.
CORTE LA BANDERERA, DOBLA E Y NUNGA USTROPIVET A LAS RINGES.