



A825-200

1/48 scale Gloster Meteor

IMPORTANT!

READ THESE POINTS BEFORE YOU BEGIN

- 1 This kit may be built more than one way. Decide on which version you may wish to build before final assembly.
- 2 "TEST FIT" all parts before cementing. Cement all parts unless otherwise indicated by the instructions.
- 3 Use paint and cement made for styrene plastic only. Trim excess plastic from parts before joining.
- 1 Paint all sub-assemblies before attaching parts.
- 2 Scrape paint away from surfaces to be cemented together.
- 3 Follow all of the numbers on the instruction sheet beginning with number one.

PAINT SUGGESTIONS

The following suggestions may be of help to you in painting your model: Use only bottle or spray paint made for styrene plastics. Allow time for paint to dry thoroughly before handling parts.

FLAT MEDIUM SEA GRAY – Lower portion of wings, fuselage, horizontal stabilizers, landing gear doors (open or closed).

FLAT TAN – Pilot's face and hands.

FLAT BROWN – Pilots' helmet and suit

SILVER – Pilot's goggles, head set, landing gear (open position), dials on the instrument panel and some of the engraving on the inside of cockpit and landing gear.

FLAT BLACK – Pilot's shoes, seat, mask, instrument panel, interior walls, engine cap (with crossbar silver), landing gear wheels (forward and wing), control stick, interior floor, inside of cockpit and wheel openings (forward and wings).

FLAT GREEN – Antenna, V-1 missile.

FLAT BATTLE GRAY – Frame of canopy.

FLAT DARK GREEN & FLAT OCEAN GRAY – For camouflage effect, paint upper portion of wings, fuselage, horizontal stabilizers. Use box art for reference.

I. FUSELAGE ASSEMBLY

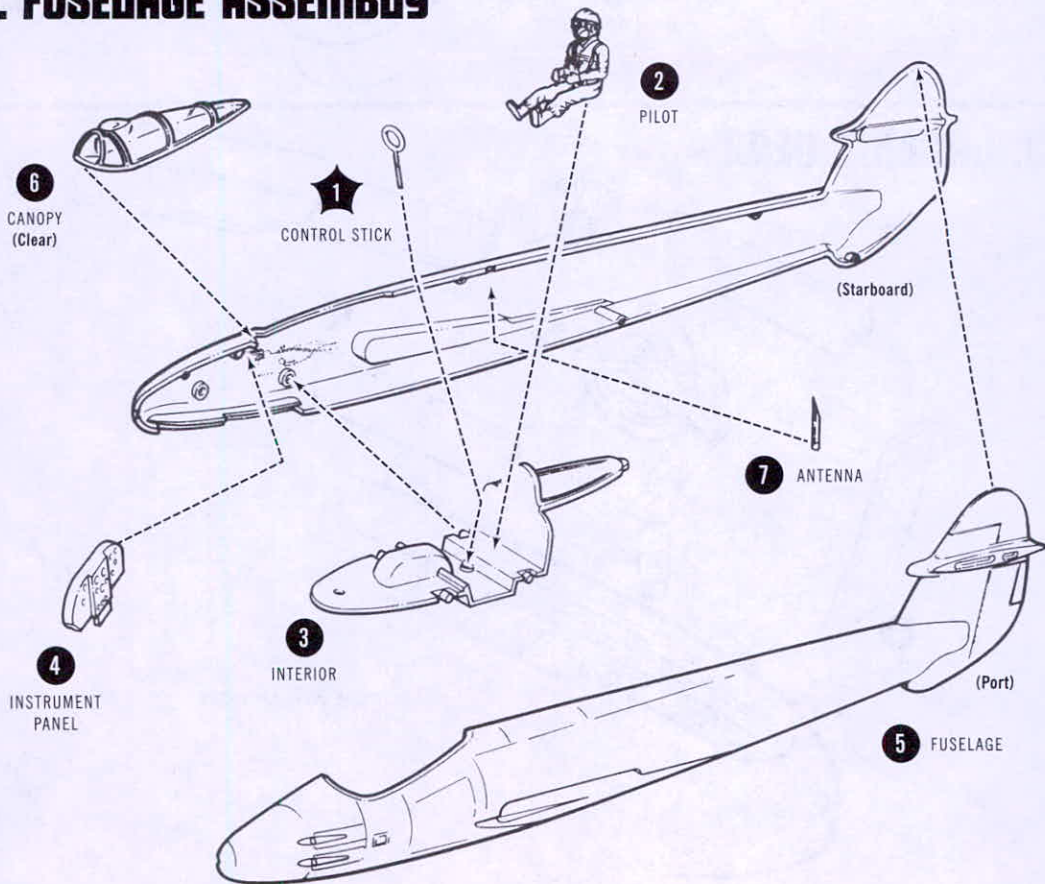

2. WING ASSEMBLY

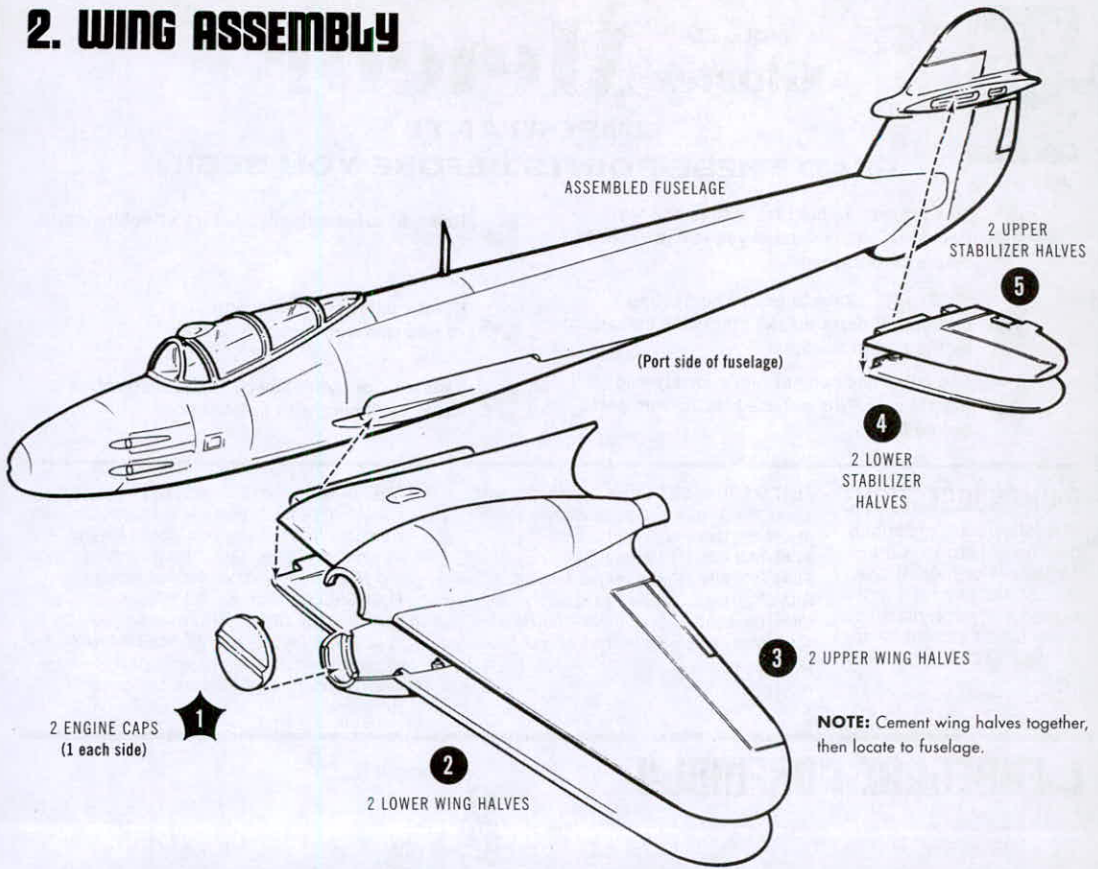

3. LANDING GEAR

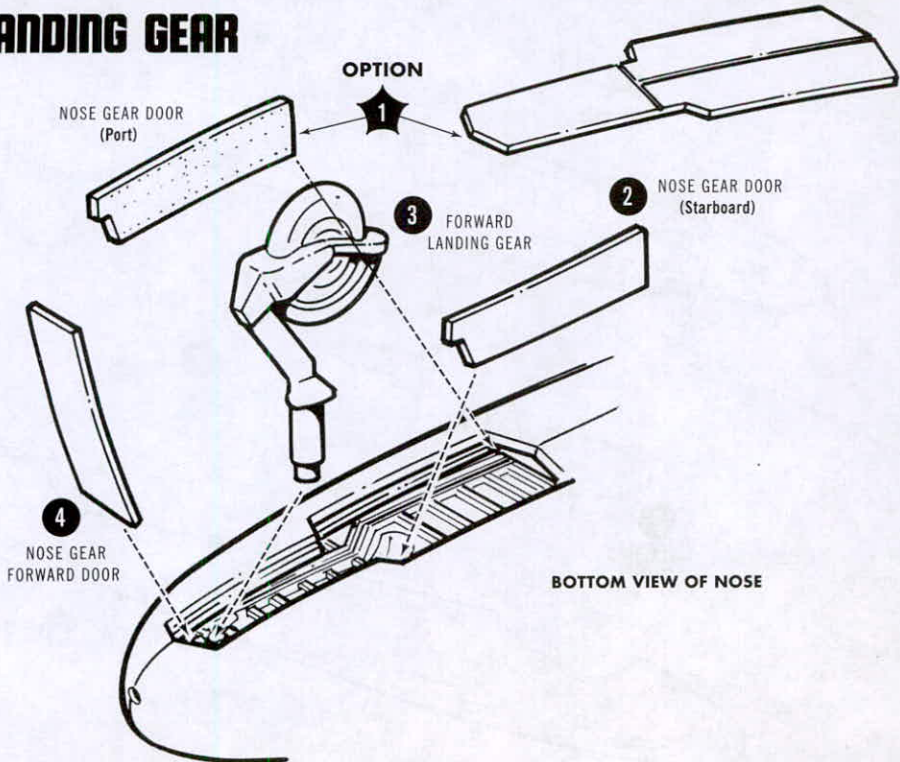

4. LANDING GEAR (Continued)

(Use in open position only)

2 LANDING GEAR WHEELS
(2 pcs. each)

NOTE:

(Port side indicated by the numbers (2) (2)
(Starboard side indicated by the numbers (1) (1))

OPTION

NOTE: Doors may be cemented in either the open or closed position.

2 LANDING GEAR INBOARD DOORS

2 LANDING GEAR OUTBOARD DOORS

(Trim off tabs for Closed position)

BOTTOM VIEW OF WING



3 TAIL SUPPORT (Clear)

NOTE: To hold up tail end when in landed position.

V-1 ROCKET ASSEMBLY

6 ROCKET ENGINE INLET CAP

5 ROCKET ENGINE (2 pcs.)

4 FUSELAGE (Upper)

2 REAR STABILIZER

3 FUSELAGE (Lower)

1 WING

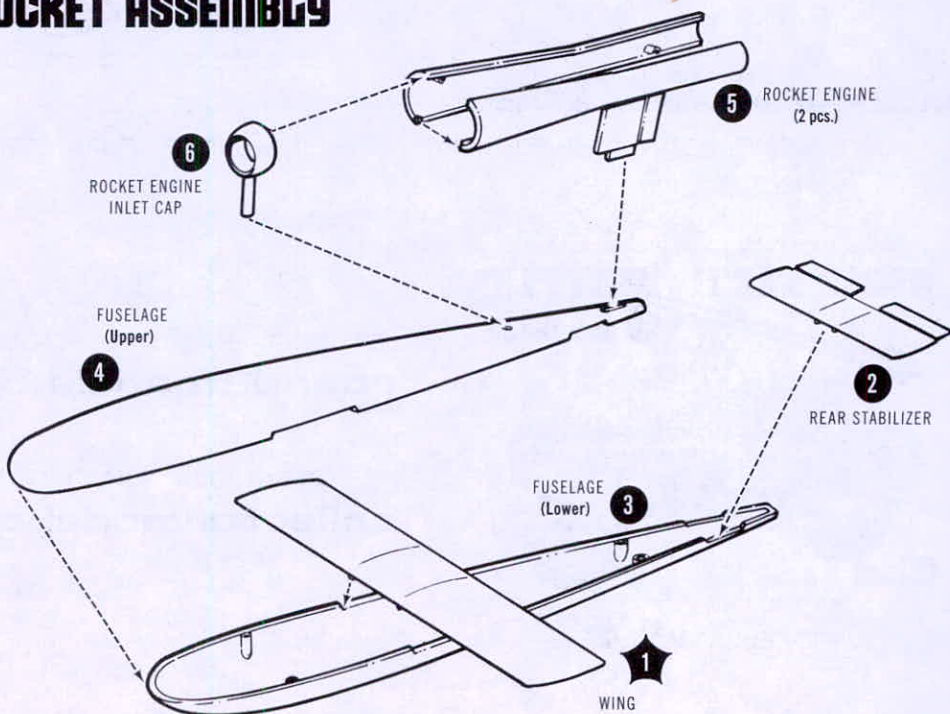

PAINTING GUIDE

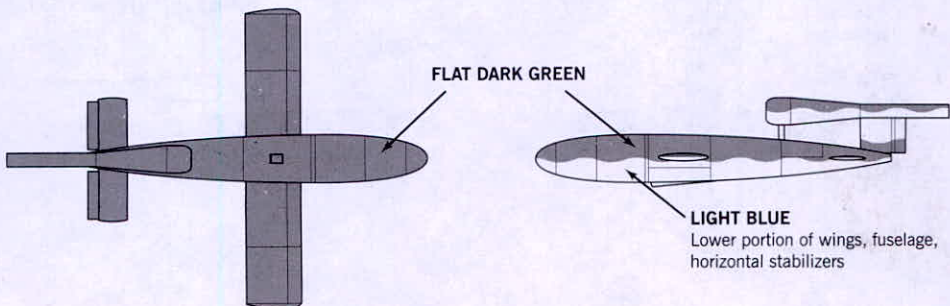
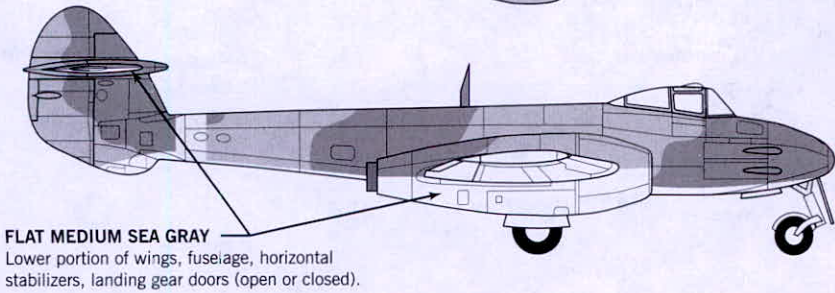
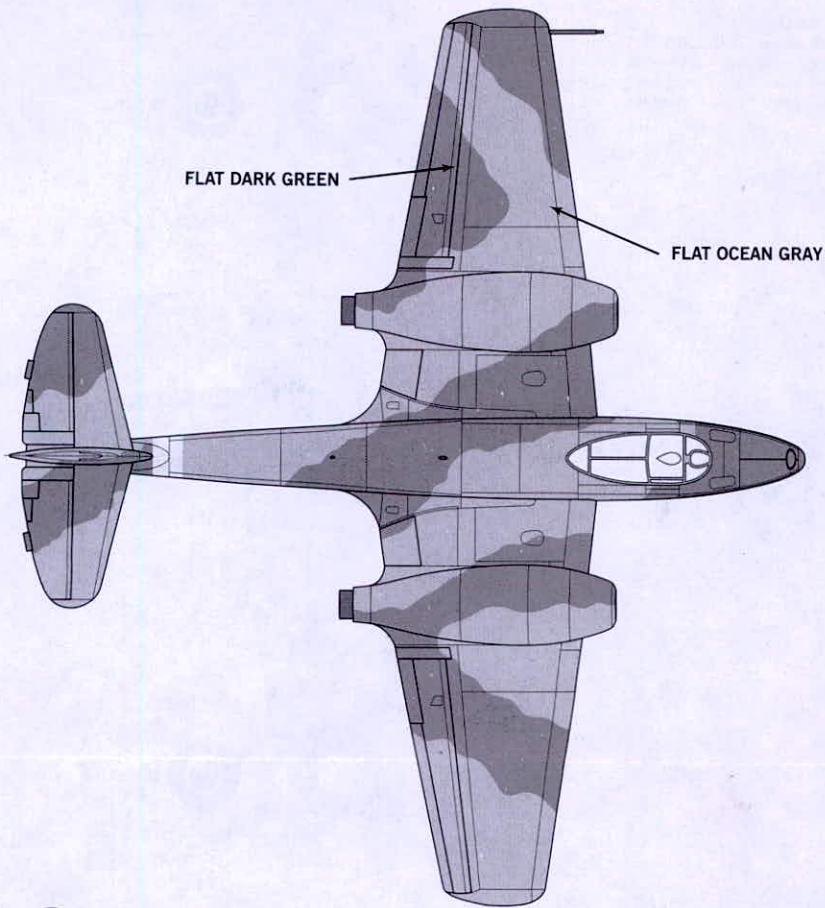

DECAL PLACEMENT

IMPORTANT NOTE:

Follow directions on back of DECAL SHEET when applying decals. Duplicates of the very small decals in this kit have been included to serve as backups, should any get lost or otherwise compromised during application.

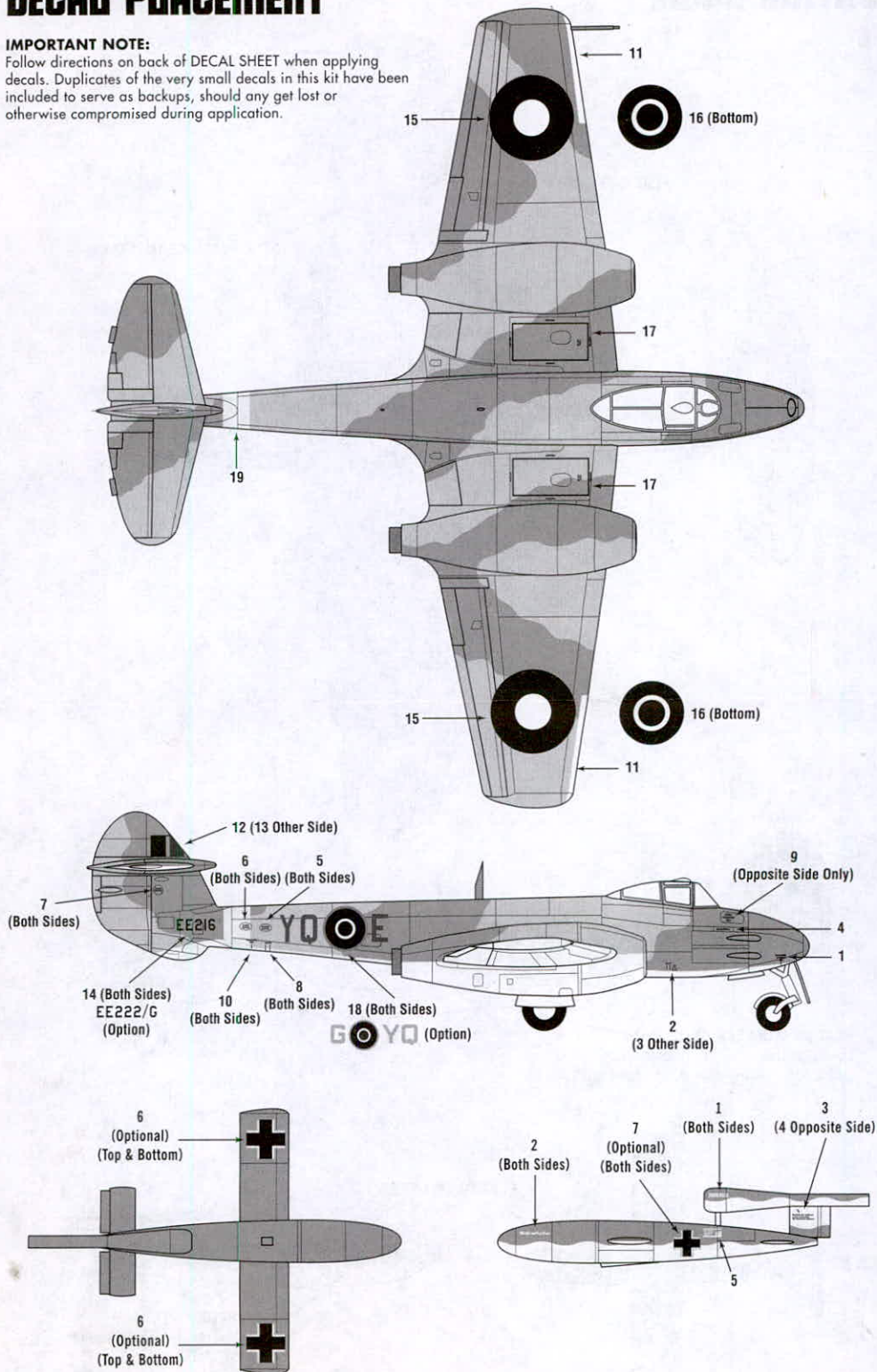

BE SURE TO LOOK FOR THESE OTHER GREAT MILITARY MODEL KITS:



AMT802 F-14A TOMCAT™



AMT820 F-16A FALCON®



AMT779 F-18A HORNET



AMT813
GRUMMAN F9F PANTHER



MPC785 WWII JEEP

For more information, visit
round2models.com

visit our blog at:
collectormodel.com