

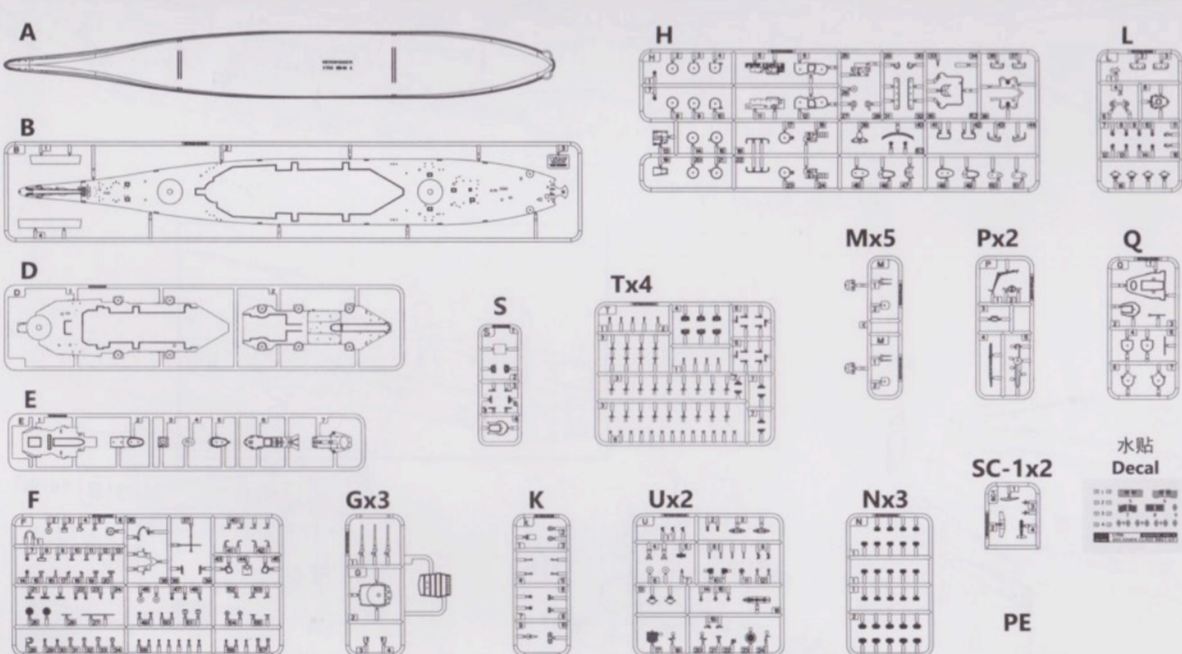

USS MISSOURI BB-63 1945.9 美国海军战列舰“密苏里”号



图标说明
Icon description:

1 步骤	Step	① 组件	Unit
B 对侧相同	Both sides	O 对侧	Opposite
X2 制作两组	Make 2sets	⊗ 钻孔	Make hole

- 组合前先阅读说明书。
Read the manual before you start assembling.
- 确认零件完整。
Confirm that the parts are all complete.
- 组件取出零件后的塑料袋，小孩子有可能把他当成帽子戴上，有窒息的危险，请把它撕掉。
After taking out the parts from the plastic bag, tear up the plastic bag. Little child may wear it over his head only to be suffocated.
- 制作过程中的零件和碎片，要放在小孩子触摸不到的地方。
While assembling the kit, place the parts and chips on a safe place out of the reach of little children.
- 使用胶水和油漆时，请打开窗户换气，避免火源。
If you desire to use an adhesive, and paint, open the window for sufficient amount of fresh air Avoid using fire nearby.

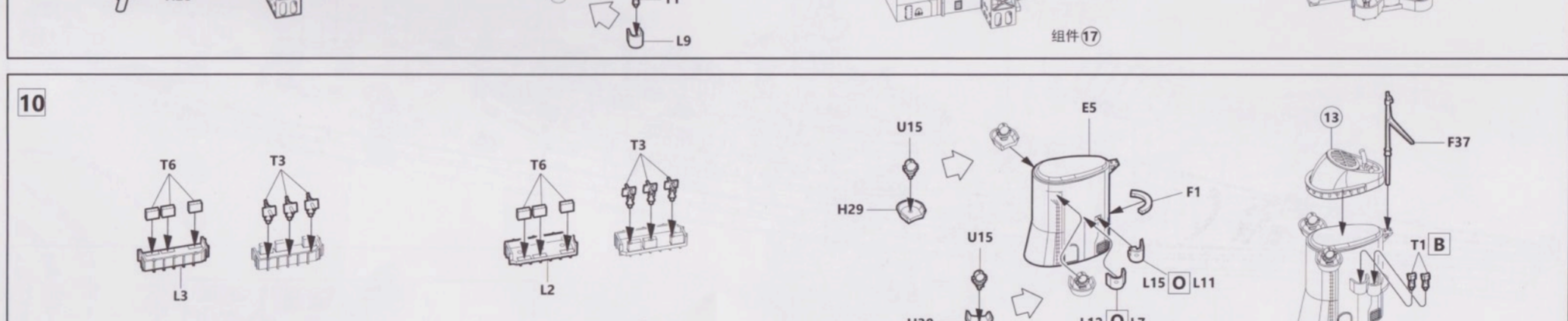
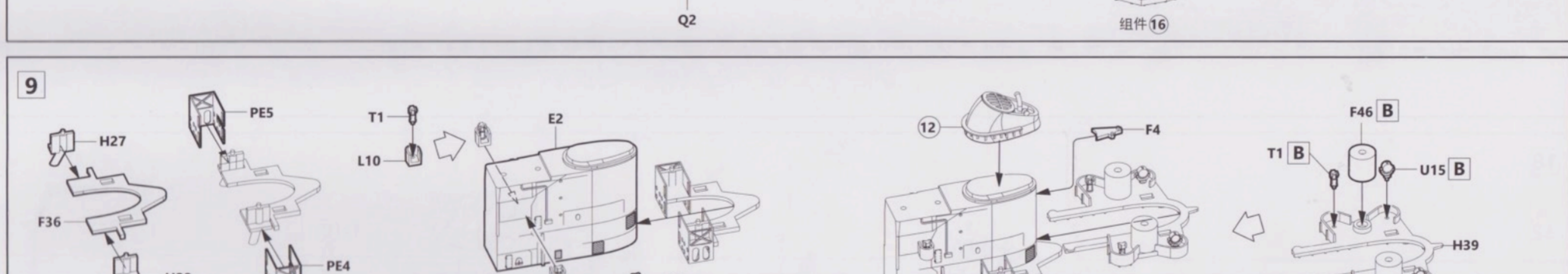
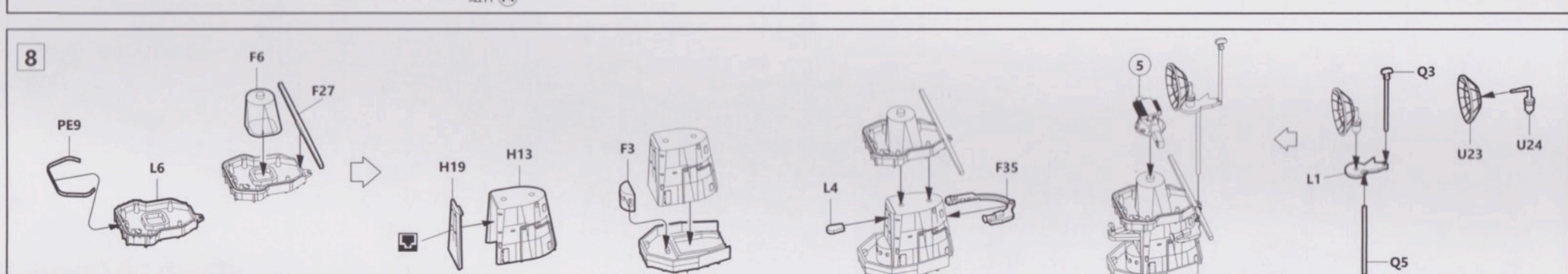
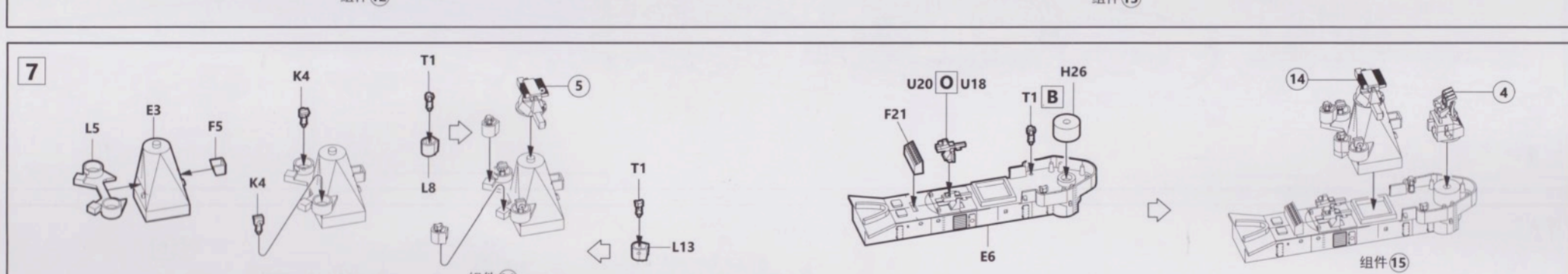
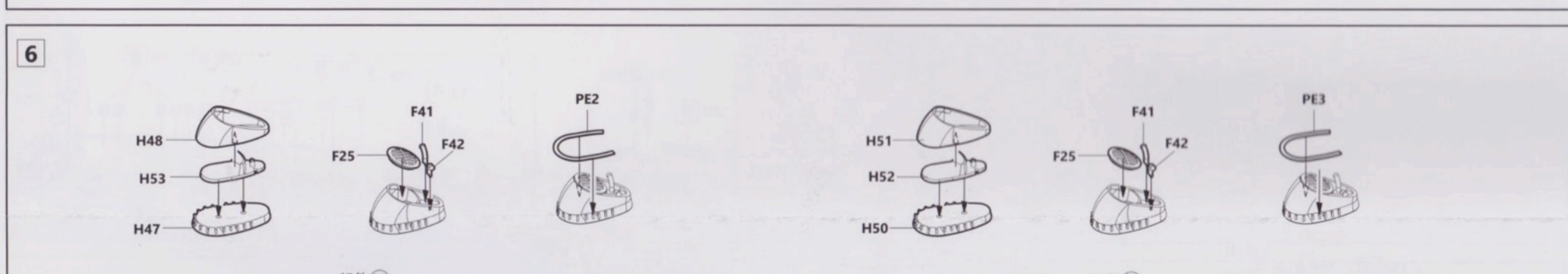
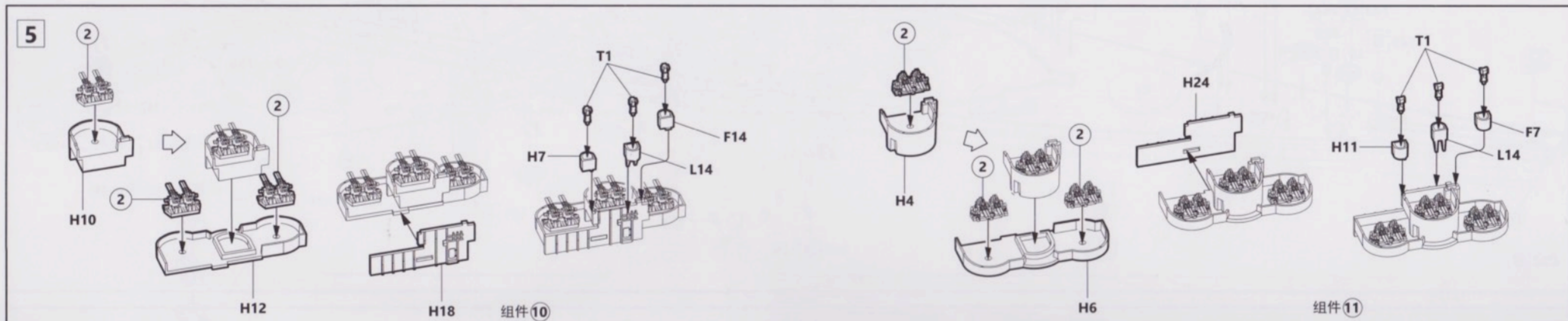
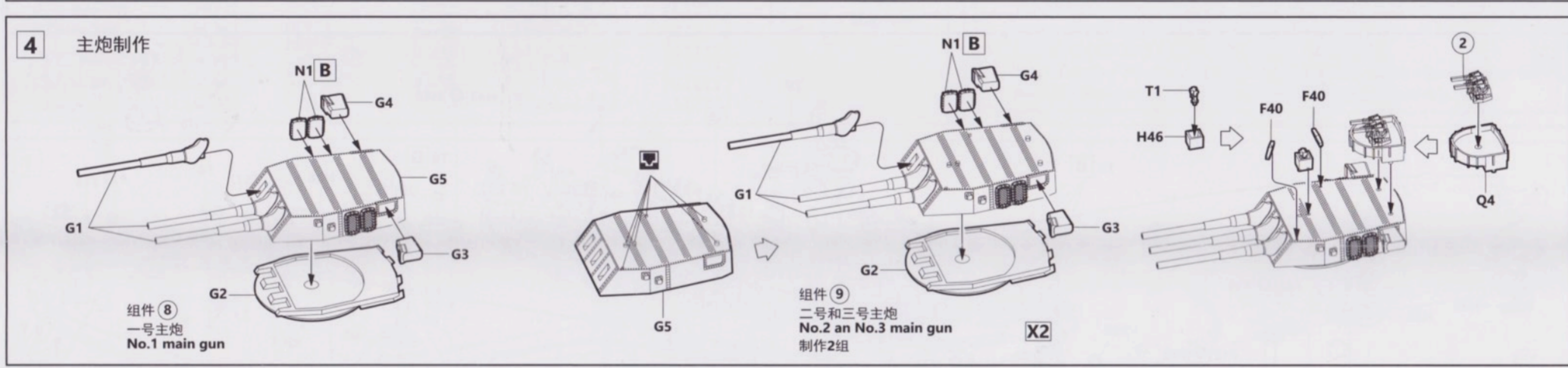
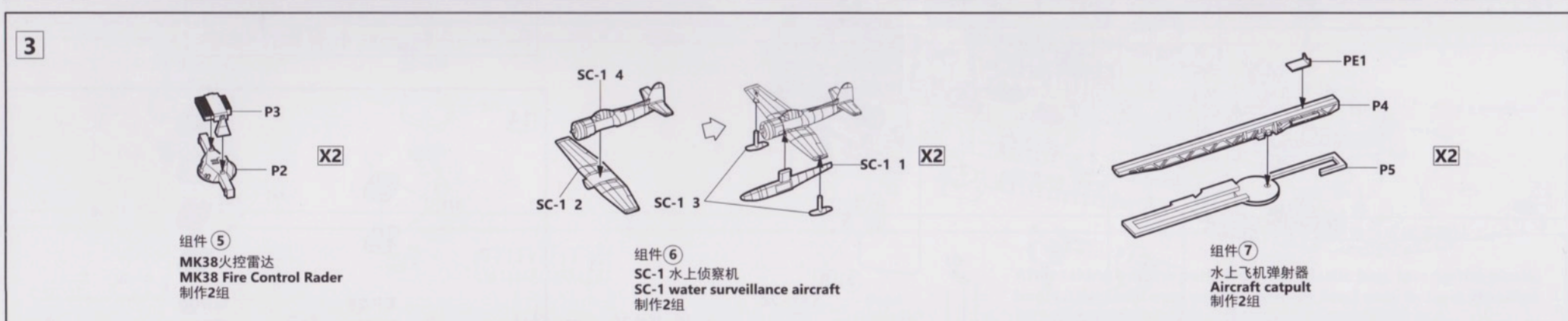
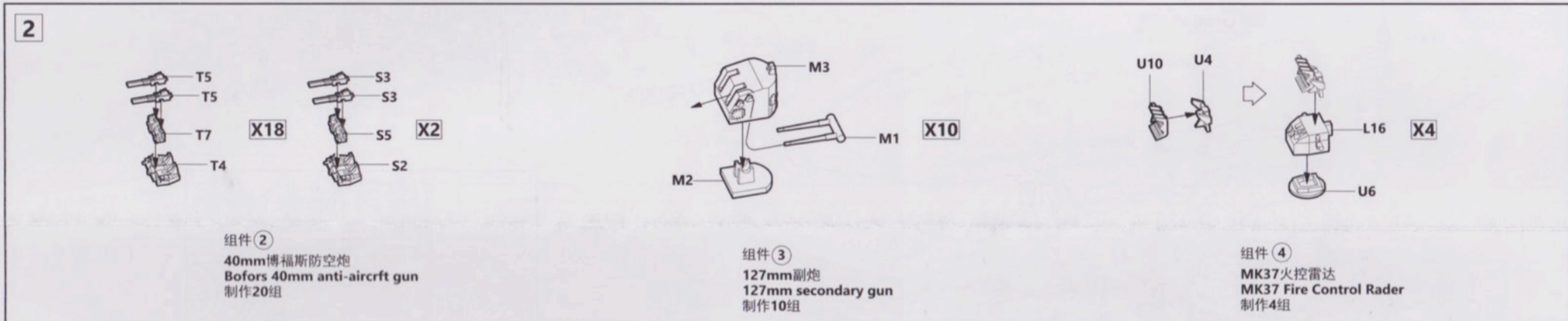
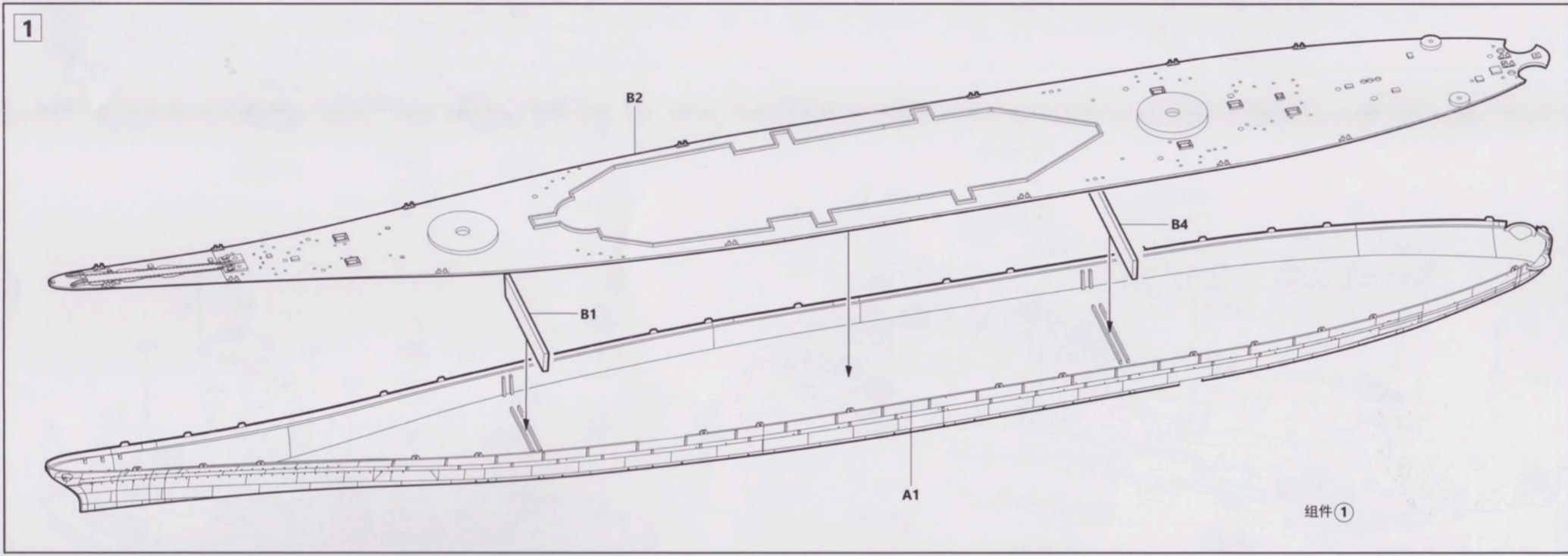

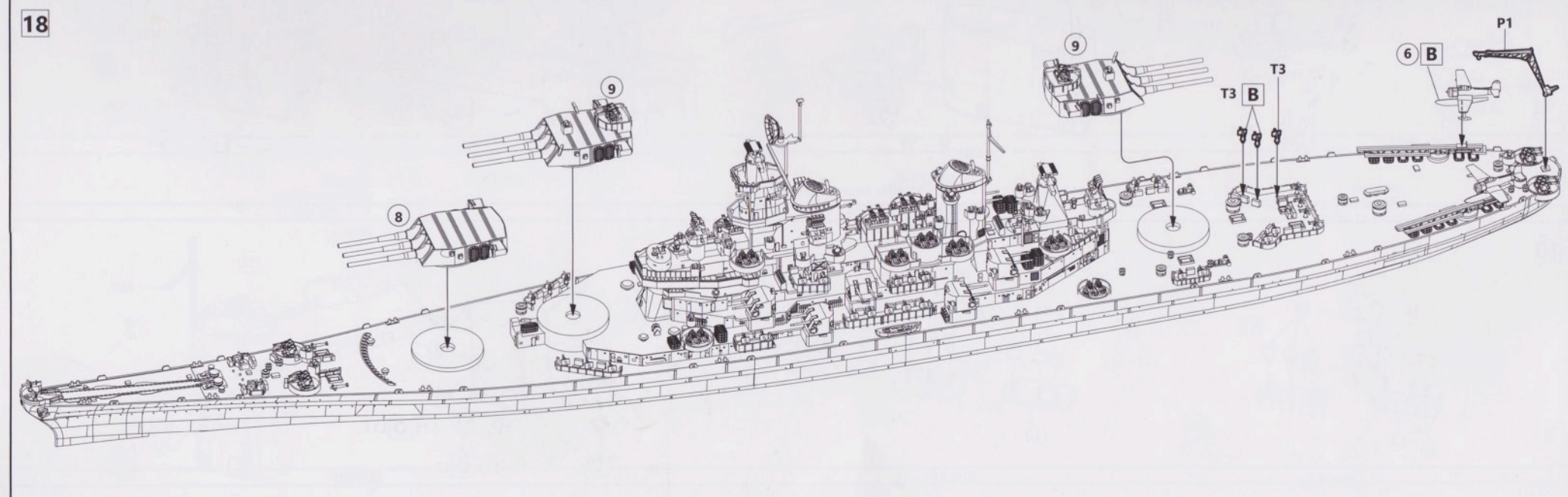
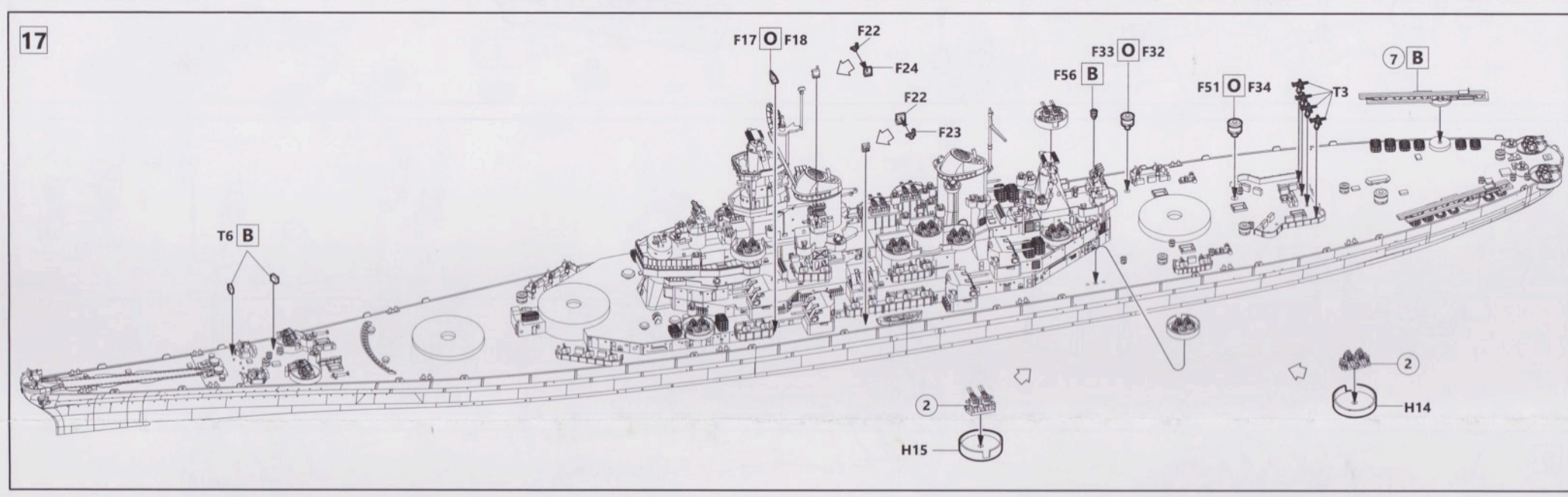
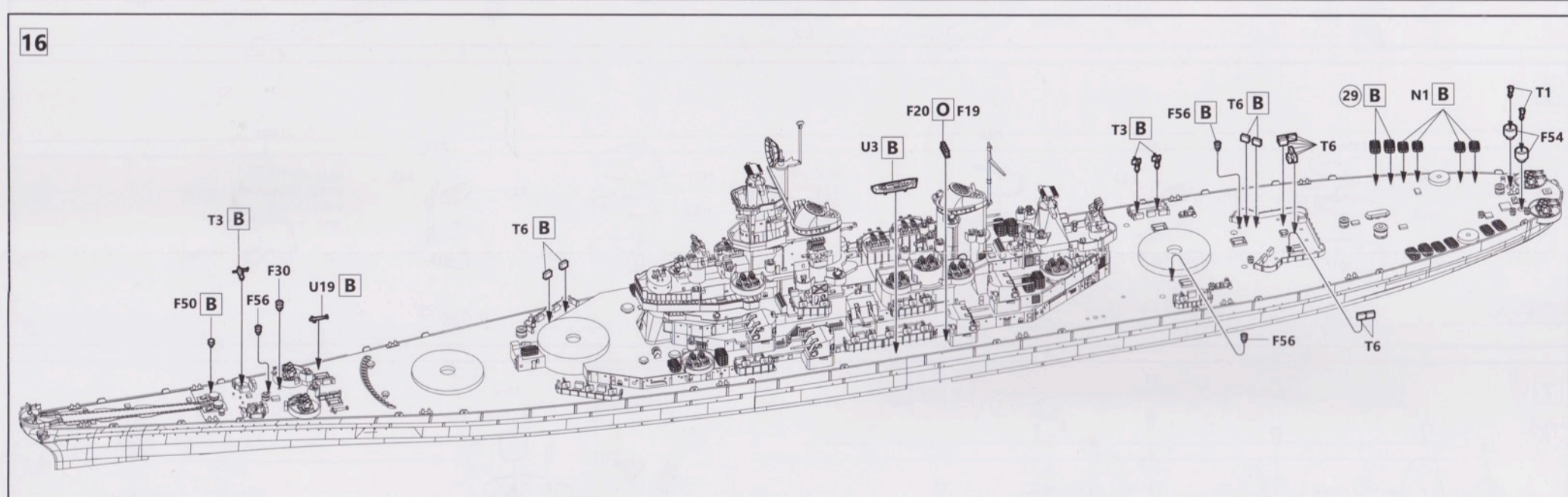
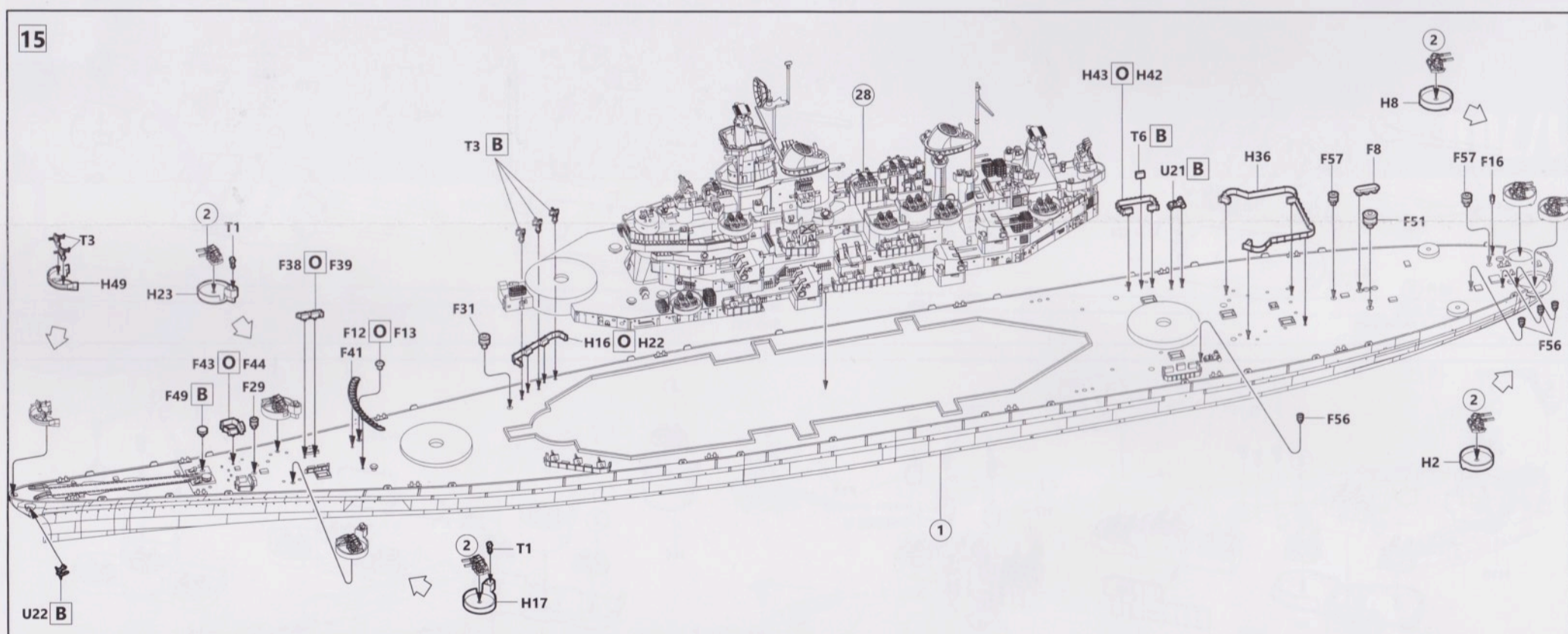
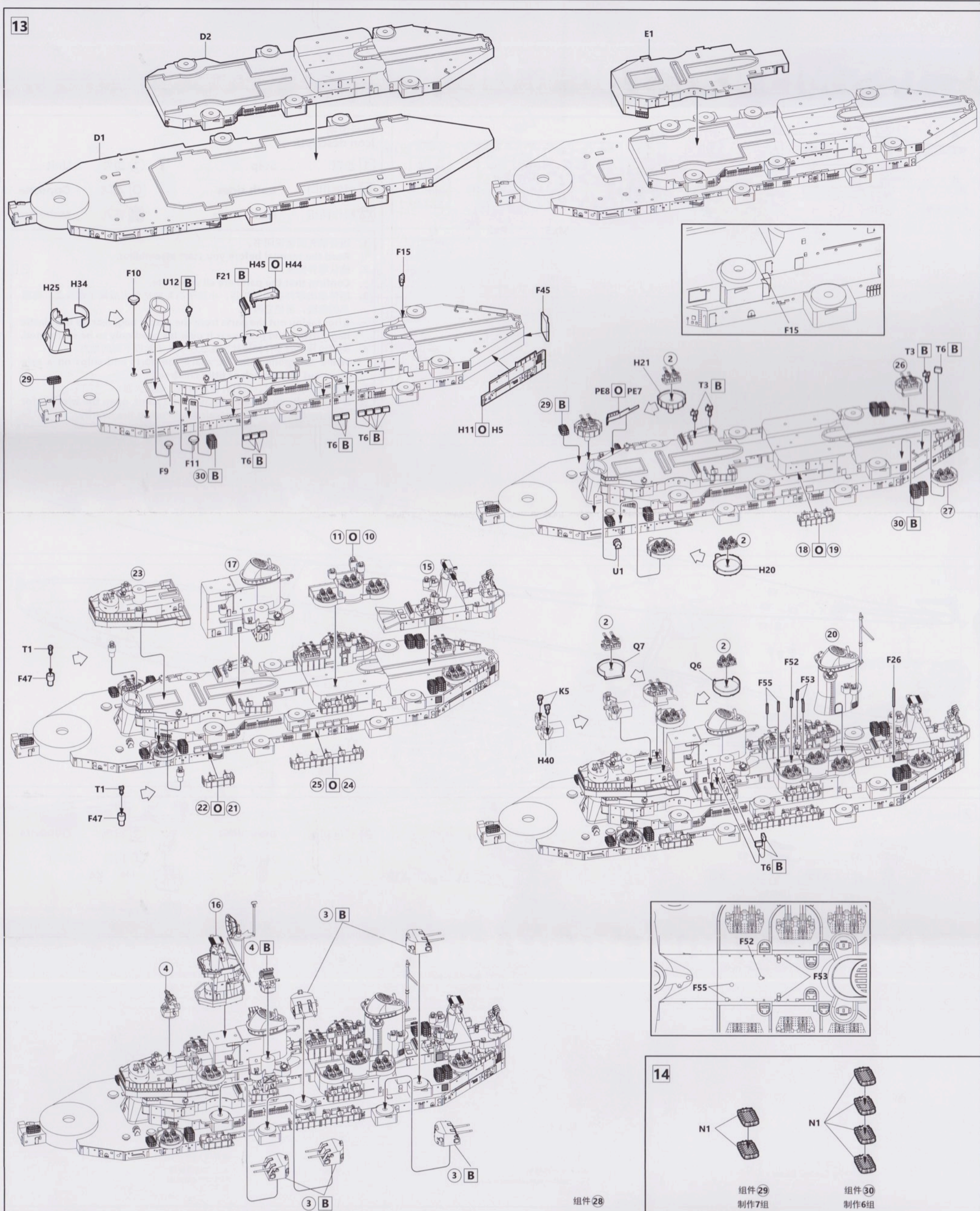
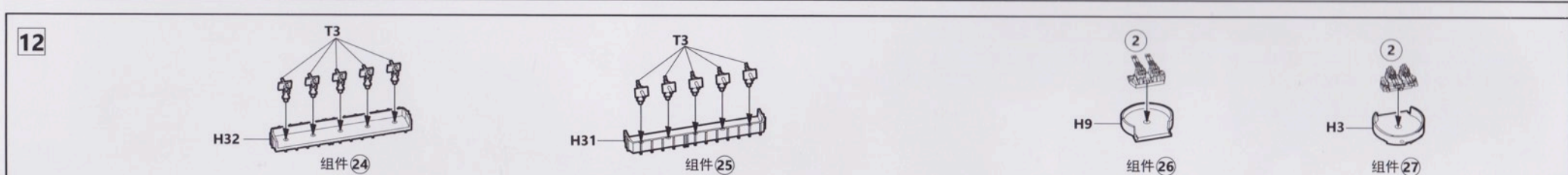
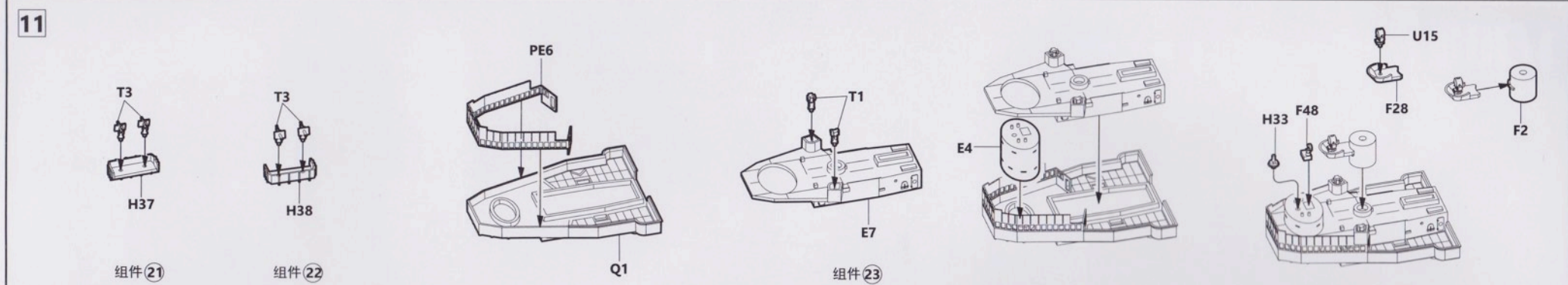

USS MISSOURI BB-63 1945

美国海军战列舰“密苏里”号

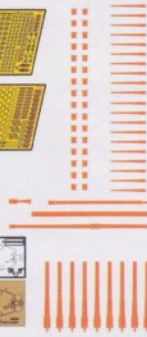
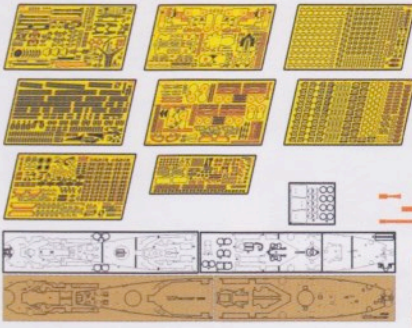

- | | |
|----------------|------------|
| I 步骤 | Step |
| B 对侧相同 | Both sides |
| X2 制作两组 | Make 2sets |
| 钻孔 | Make hole |
| 切断 | Cut off |
| 对侧 | Opposite |
| 折叠 | Bend |
| 弯曲 | Roll |
| 选择 | Choose |

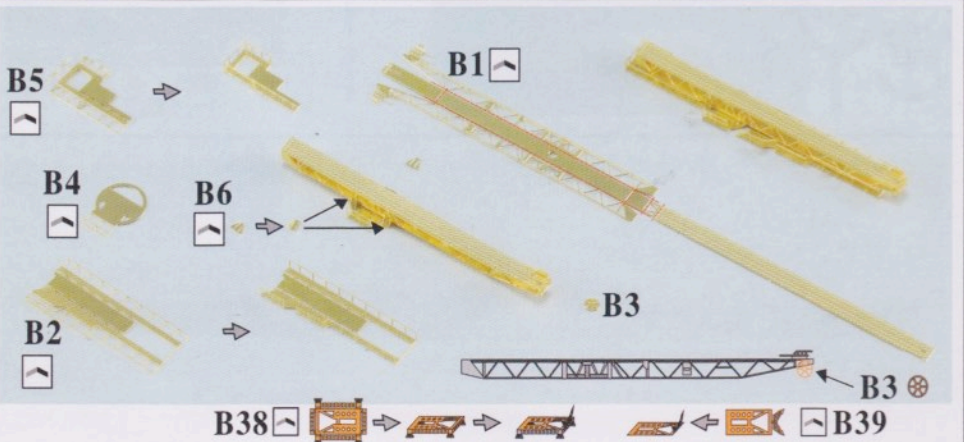
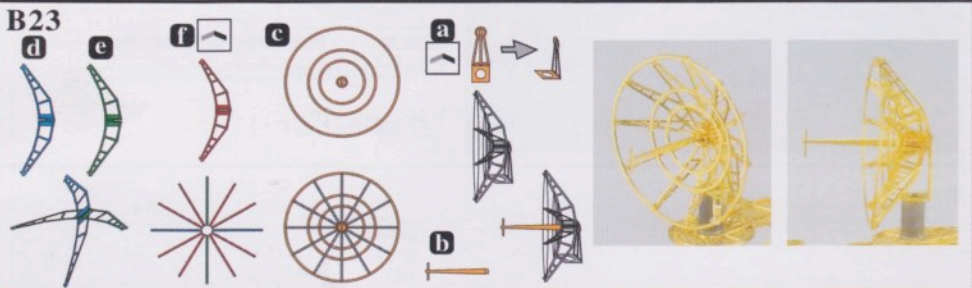
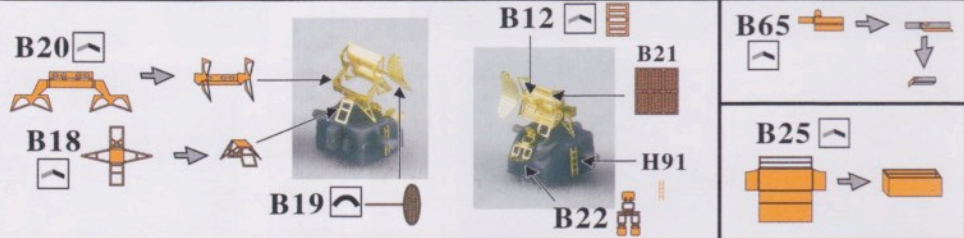
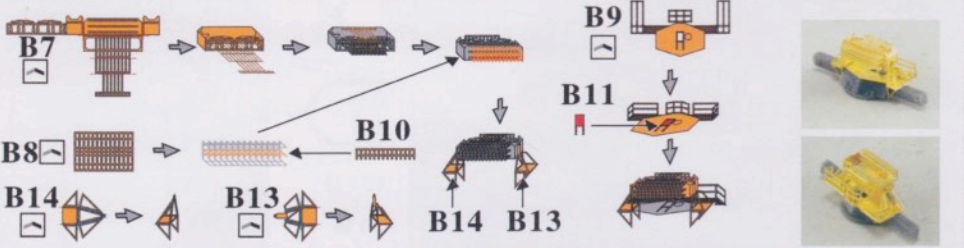

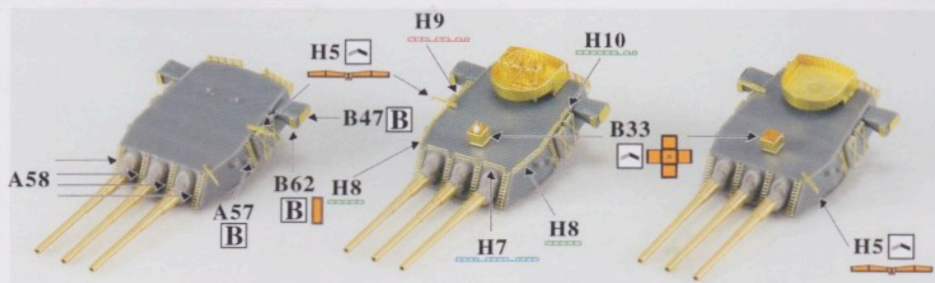
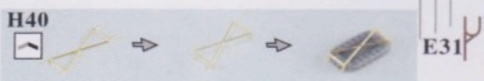
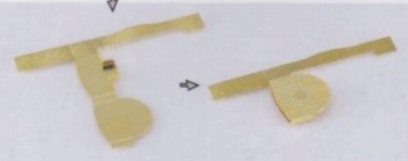
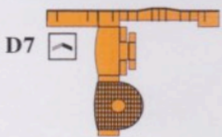
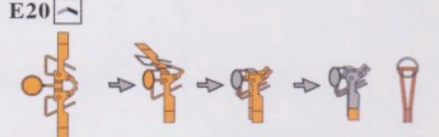
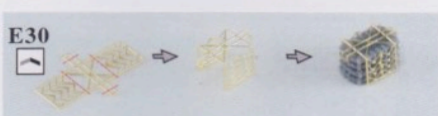
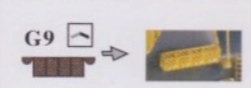
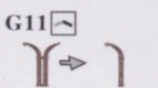
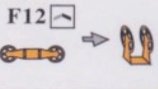
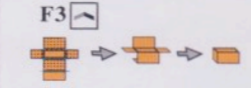
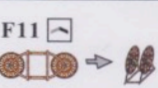
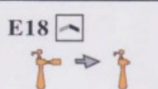
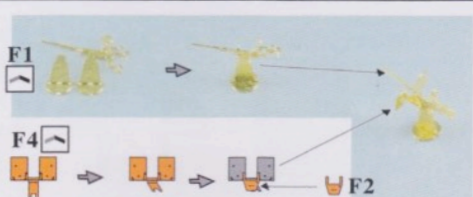
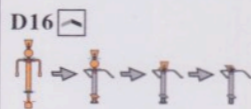
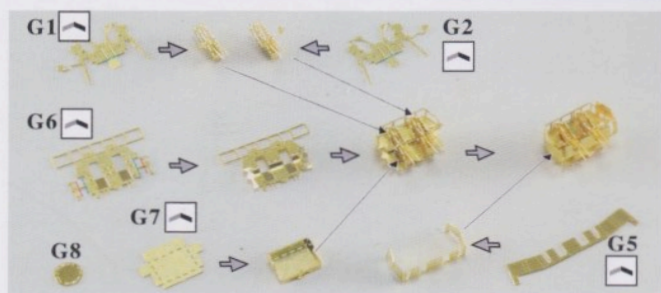
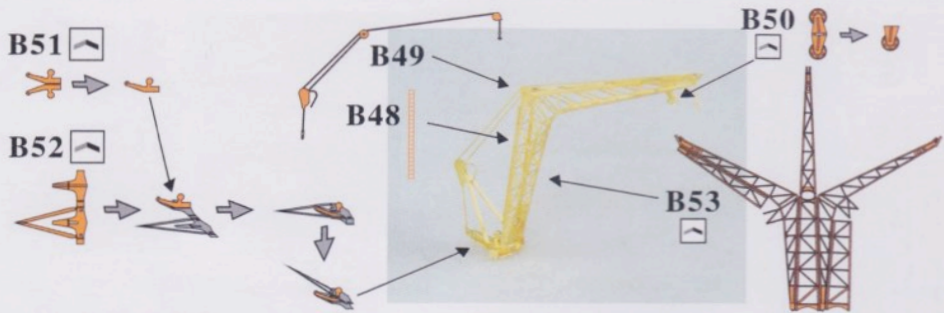

H7, H8, H9, 只安装在B炮塔
H7, H8, H9 only turret B

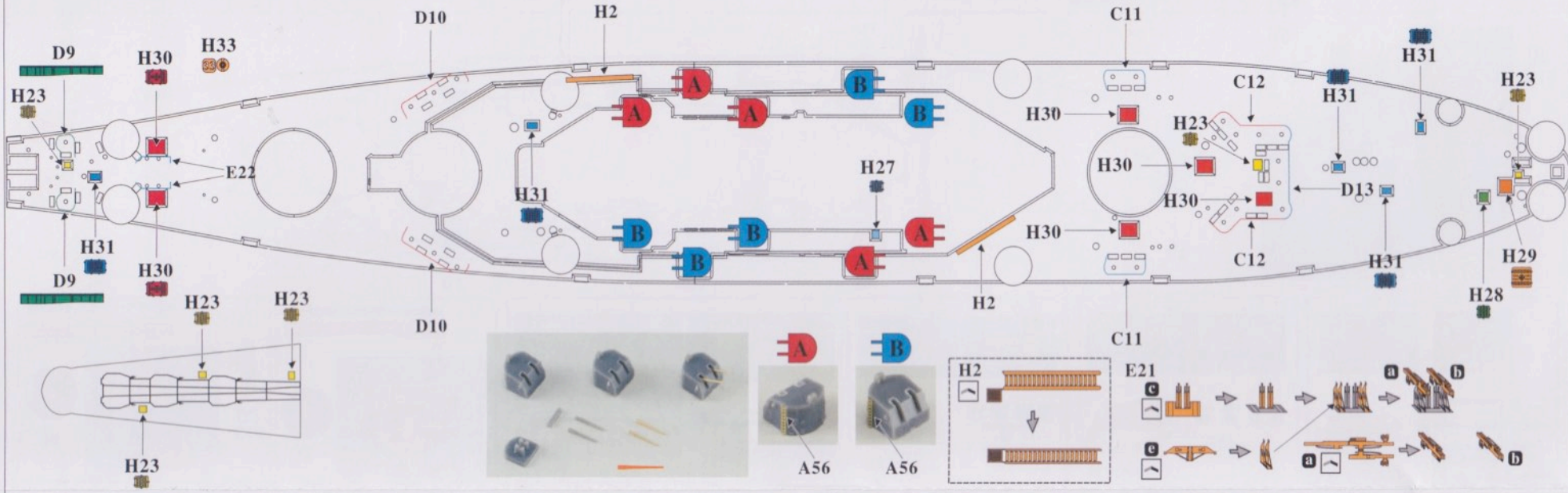
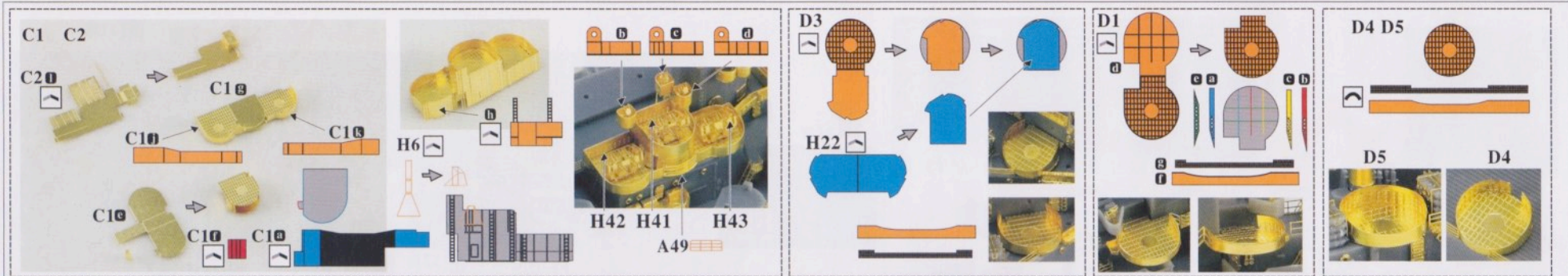

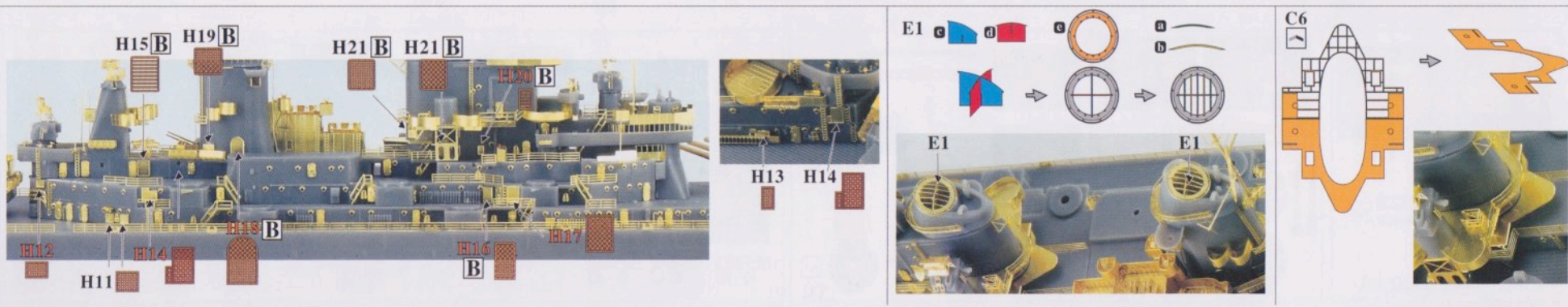
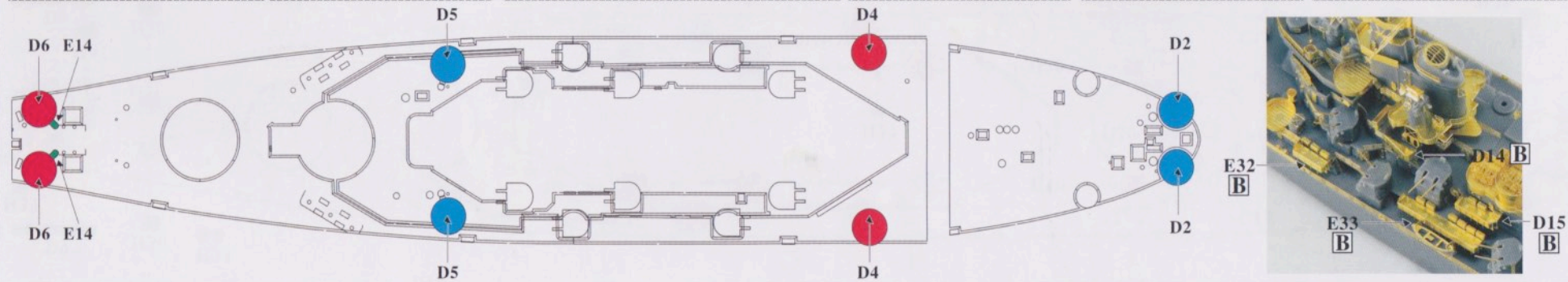
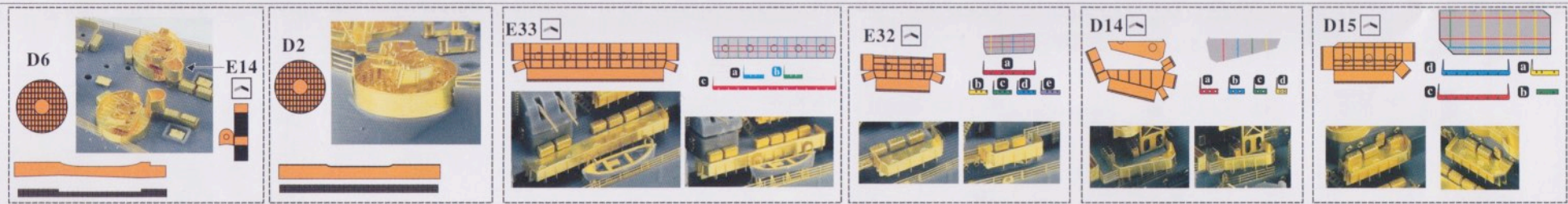

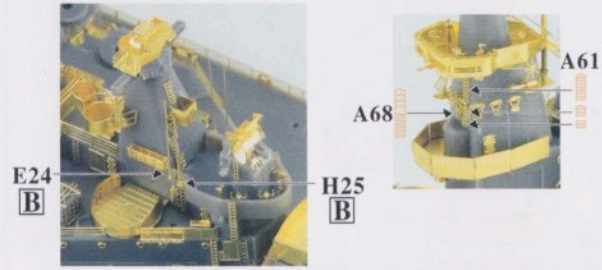
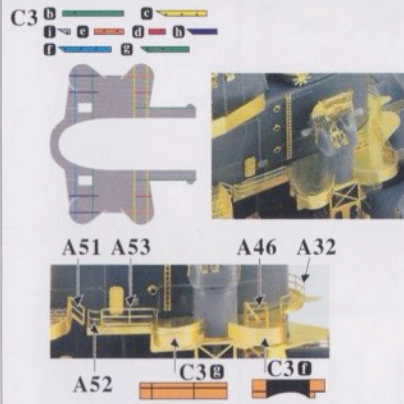
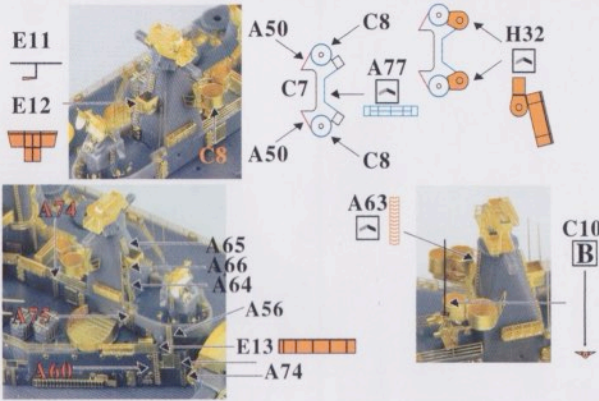

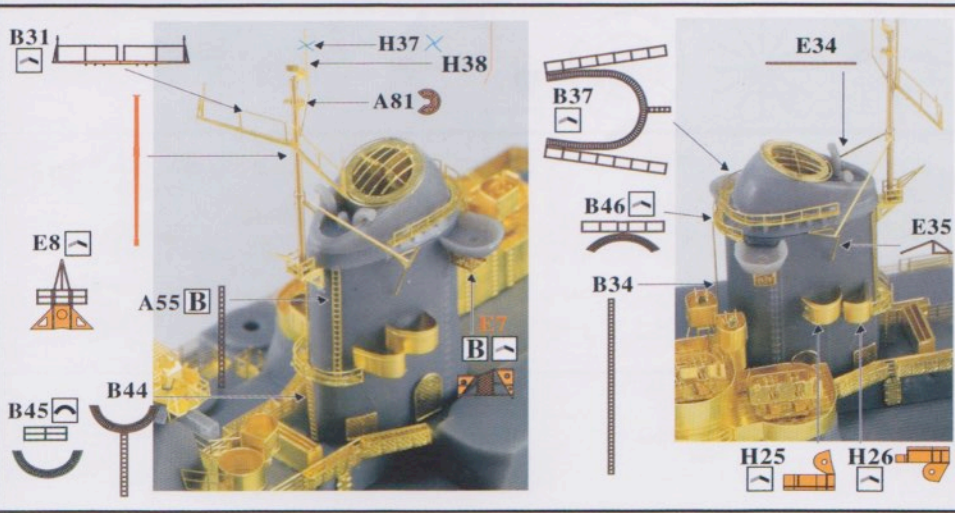
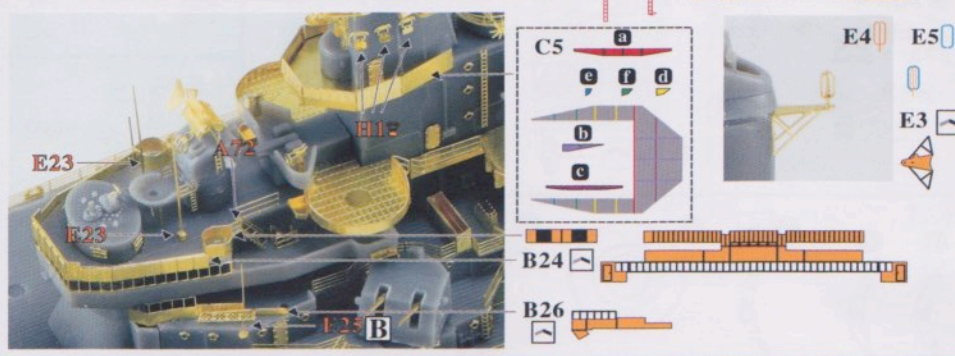
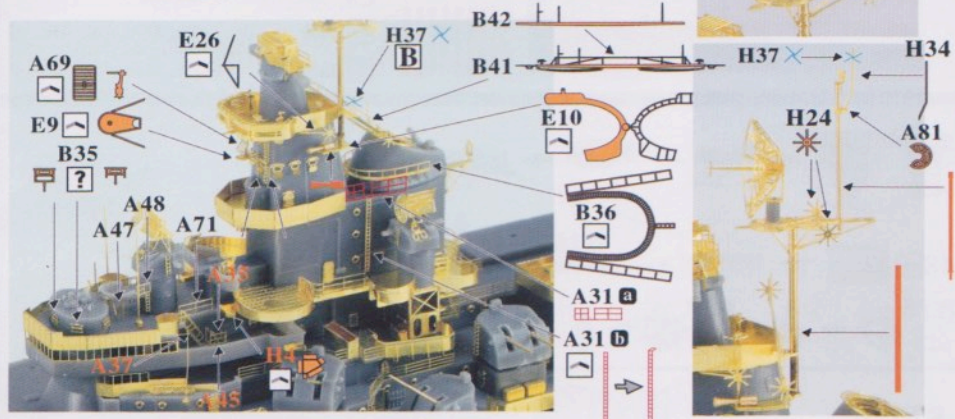
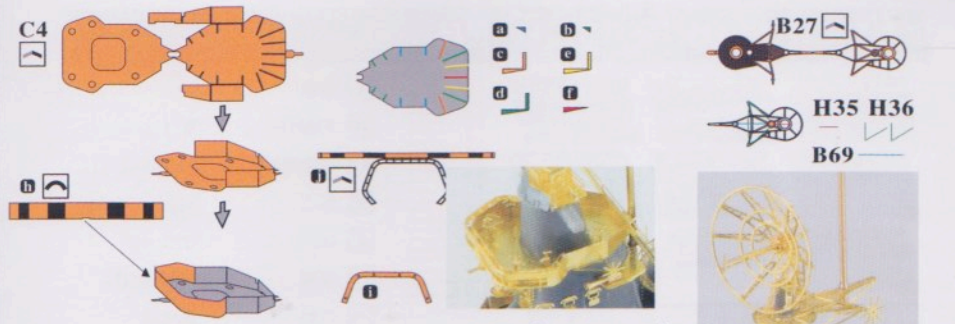

颜色	配色方案	颜色	配色方案
5U	C311	5N	C14:C72=50%:50%
5P	C308	5D	C14:C72=75%:25%
5L	C307	DB	C305:C33=25%:75%
5H	C337	FDS	C305:C72=90%:10%
5O	C366	20B	C72:C305:C14=50%:40%:10%
5S	C14:C72=25%:75%		

