



## NÁVOD / INSTRUCTION MD-500E

1/72

### CZ - Historie

Vrtulníky řady MD-500/Hughes 500 slouží jako lehké užitkové civilní i vojenské prakticky po celém světě. Vývoj vrtulníku zahájila firma Hughes podle požadavků armády USA na lehký pozorovací vrtulník již na začátku šedesátých let. První vrtulník továrního označení model 369 a vojenského OH-6 Cayuse vzletl poprvé již v roce 1963. Byl dodáván jako vojenský i civilní. V roce 1976 byla do výroby zavedena nová verze 500D s novým pětistupňovým rotorem, přepracovaným nosníkem vyrovnávacího rotoru s ocasními plochami ve tvaru T a možností instalace čtyřlístového vyrovnávacího rotoru.

V roce 1982 byly zavedeny do výroby verze 500E a 530F s novým provedením kabiny pilotů a cestujících. Zahrocená před těchto verzí nabídla větší pohodlí a prostor v interieru. Verze 530F disponuje navíc výkonnějším motorem pro práce v horkém a vysokohorském prostředí. Od roku 1984 jsou vrtulníky vyráběny pod označením MD-500E a MD-530F firmou McDonnell Douglas, později MD Helicopter Inc. Vojenské varianty nesou jméno Defender. Pod označením NH-500E jsou MD-500E licenčně vyráběny firmou Augusta (Breda-Nardi) v Itálii.

V poslední dekádě minulého století byla do výroby zavedena verze MD-520N s unikátním ventilátorovým systémem vyrovnávání rotočního momentu hlavního rotoru. Systém je označován jako NOTAR a kromě nižšího hluku přispívá hlavně k větší bezpečnosti provozu.

Délka: 9,4 m, Průměr rotoru: 8,1 m, Výška: 2,6 m, Max. rychlost: 282 km / h, Dolet: 429 km, Dostup: 4877 m, Stoupavost: 9 m/s

### EN - History

The MD-500 series light utility civilian and military helicopters have seen service around most of the world. Hughes company started the development of this machine in response to a US Army requirement for a light observation helicopter at the beginning of the 1960s. The prototype of the Hughes Model 369 (military designation OH-6 Cayuse) was taken aloft for the first time in 1963 and production machines were supplied to civilian and military customers alike. In 1976, a new version known as the Hughes 500D was introduced and differed in having a new five-bladed main rotor assembly, redesigned tail boom, T-shaped vertical stabilizer and also an optional four-bladed tail rotor.

In 1982, two new versions appeared, the Hughes 500E and 500F with a recontoured forward canopy and redesigned interior providing more comfort for both the pilot and the passengers. The 500F was also equipped with a more powerful engine optimized for hot and high work. In 1984, Hughes Helicopters was acquired by McDonnell Douglas bringing the change to the type's designation, the 500 series being produced from then on as the MD 500. Finally, since 1999, the type is produced by MD Helicopter Inc company. The military versions of the 500 series are known as the Defender, while the type MD-500E is also produced under licence in Italy by Agusta (Breda-Nardi).

In the early 1990s, the MD-500N version was also developed, equipped with a unique NOTAR system that eliminates the need for a standard tail rotor by using a set of slots in the tail boom and the Coanda effect to counteract the torque of the main rotor. Another benefits of this configuration is reduced level of noise and increased operational safety.

Length: 9.4m, Main Rotor Diameter: 8.1m, Height: 2.6m, Max.Speed: 250km/h, Range: 429km, Ceiling: 4,877m, Rate of Climb: 9m/s

PLASTIC PARTS

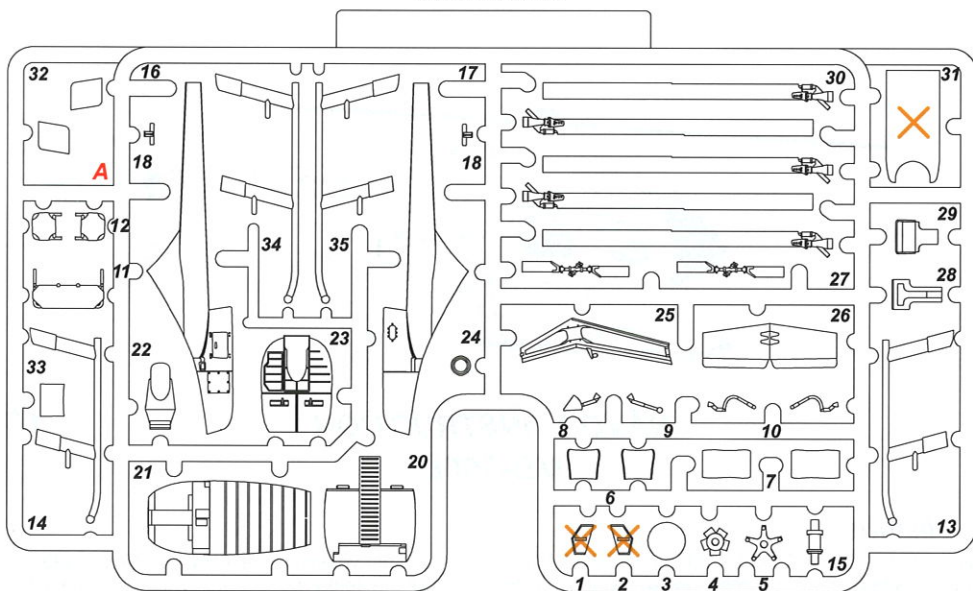

CLEAR PARTS

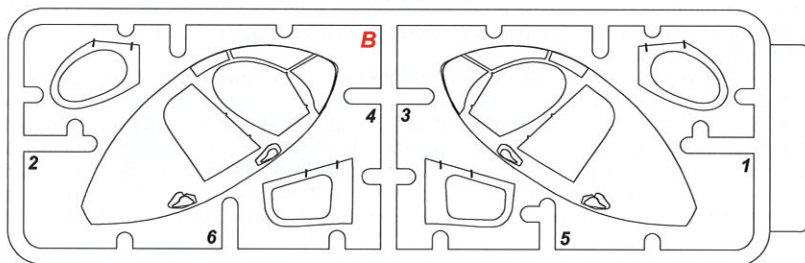
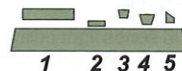
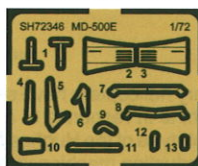

PHOTO-ETCHED PARTS PP

POLYURETHAN PARTS PUR



Tento díl nepoužít  Do not use this part

**Rapier GUNZE/ GUNZE Colour No.**

<b>A</b> Černá / Black	H2 / C2	<b>F</b> Světlá zelená/ Light Green	H312/ C312	<b>K</b> Signální Červená/ Dayglo Red	C171
<b>B</b> Matná černá/ Matt Black	H12 / C33	<b>G</b> Písková/ Sand	H27 / C44	<b>L</b> Kouřová/ Smoke Clear	H95/ C101
<b>C</b> Bílá / White	H1 / C1	<b>H</b> Modrá/ Blue	H25 / C34		
<b>D</b> Hliník / Aluminium	H8 / C8	<b>I</b> Žlutá/ Yellow	H4 / C4		
<b>E</b> Olivová zelená/ Olive Green	H303 / C303	<b>J</b> Signální Oran./ Dayglo Oran.	C173		

SYMBOLS

 MOŽNOST VOLBY OPTIONAL NACH BELIEBEN OPTION	 POUŽÍT KYANOAKRYLÁTOVÉ LEPIDLO INSTANT CYANOACRYLATE GLUE ZYANOAKRYLÁTKLEBER COLLE CYANOACRYLAT	 OHNOUT BEND BIEGEN COURBER	 ZHOTOVIT NOVÉ SCRATCH BUILD FERTIGSTELLEN ACHEVER	 ŘEZAT/VRTAT CUT OFF/DRILL ENTFERNEN DETACHER	 GSI <b>A</b> colours code	 NATŘÍT COLOUR FARBEN FEINDRE
---	--	---	--	---	--	---

**1** Díly A20, 21, 22 a 23 slepte jako první  
**First assemble parts A20, 21, 22 and 23 together**

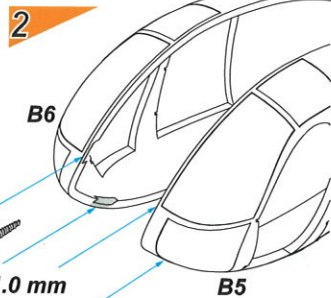
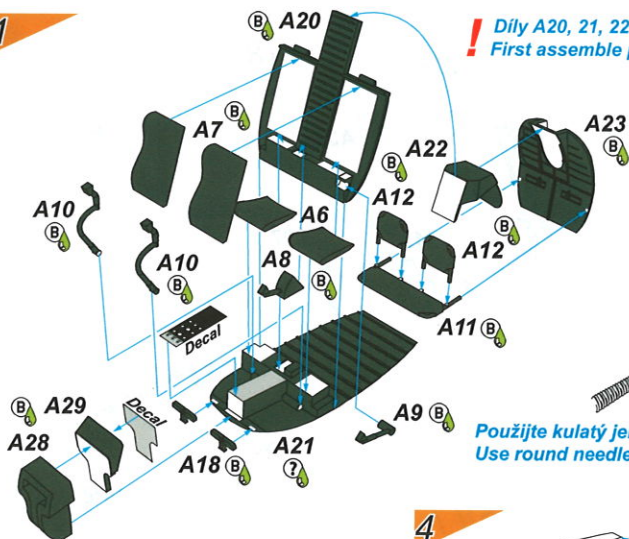

Použijte kulatý jehlový pilník  
 Use round needle-shaped file

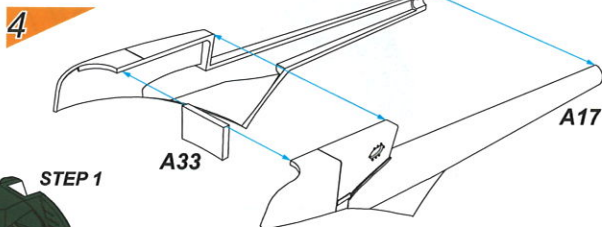
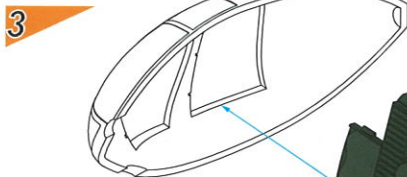

**INTERIÉROVÉ BARVY**

Rámy oken:

-kam. A, B, C černá (A)

Stěny a sloupky vč. dveří:

-kam. A bílá (C)

-kam. B ol. zelená (E)

-kam. C černá (A)

Podlaha:

-kam. A, C černá (A)

-kam. B přední část ol. zelená (E)

zadní část bílá (C)

**INTERIOR COLOURS**

Window frames:

-Cam. A, B, C Black (A)

Walls and door pillars

incl. doors:

-Cam. A White (C)

-Cam. B Ol. Green (E)

-Cam. C Black (A)

Floor:

-Cam. A, C Black (A)

-Cam. B

front part Ol. Green (E)

rear part White (C)

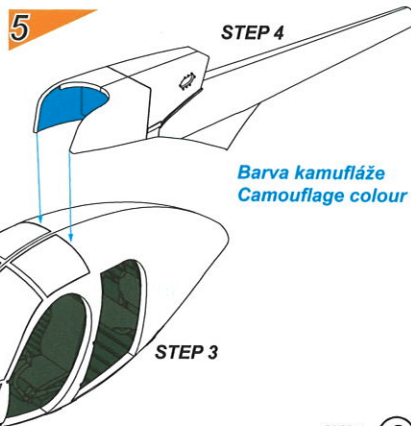
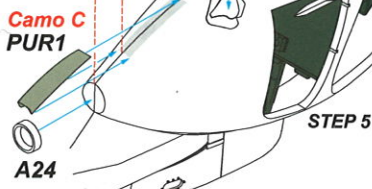

7

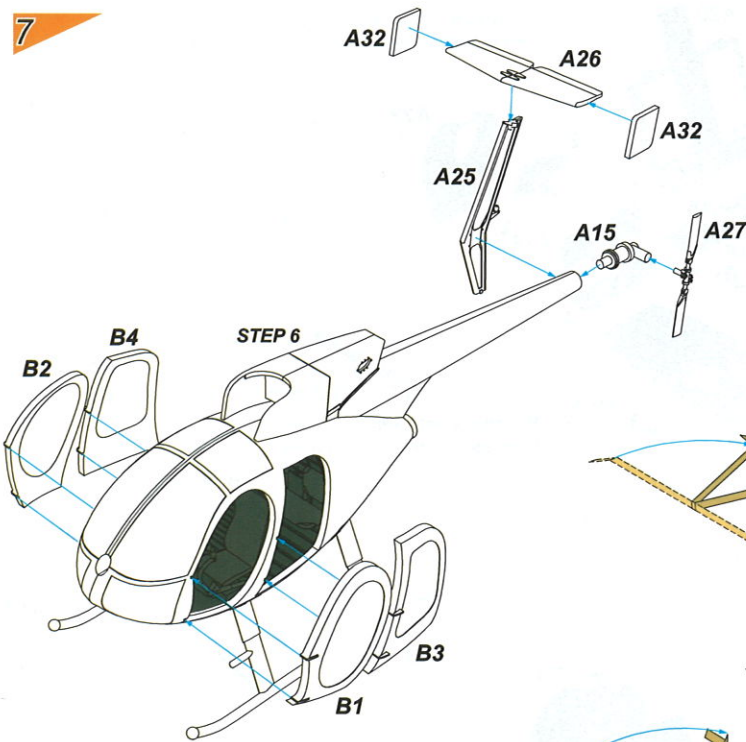

8

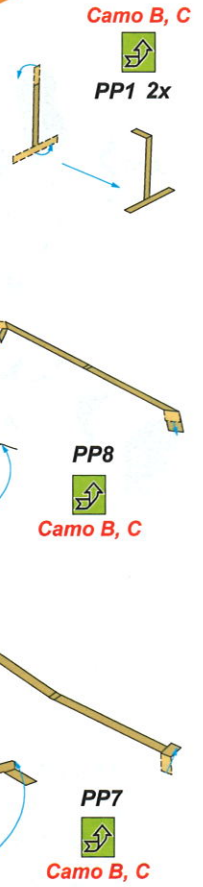

9

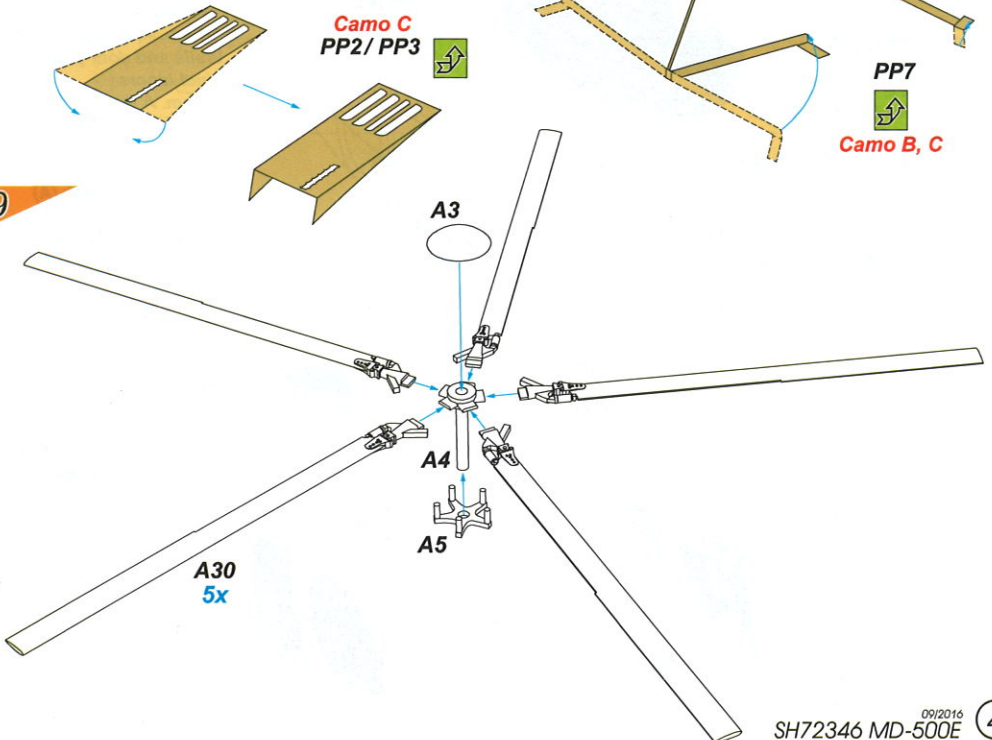

10

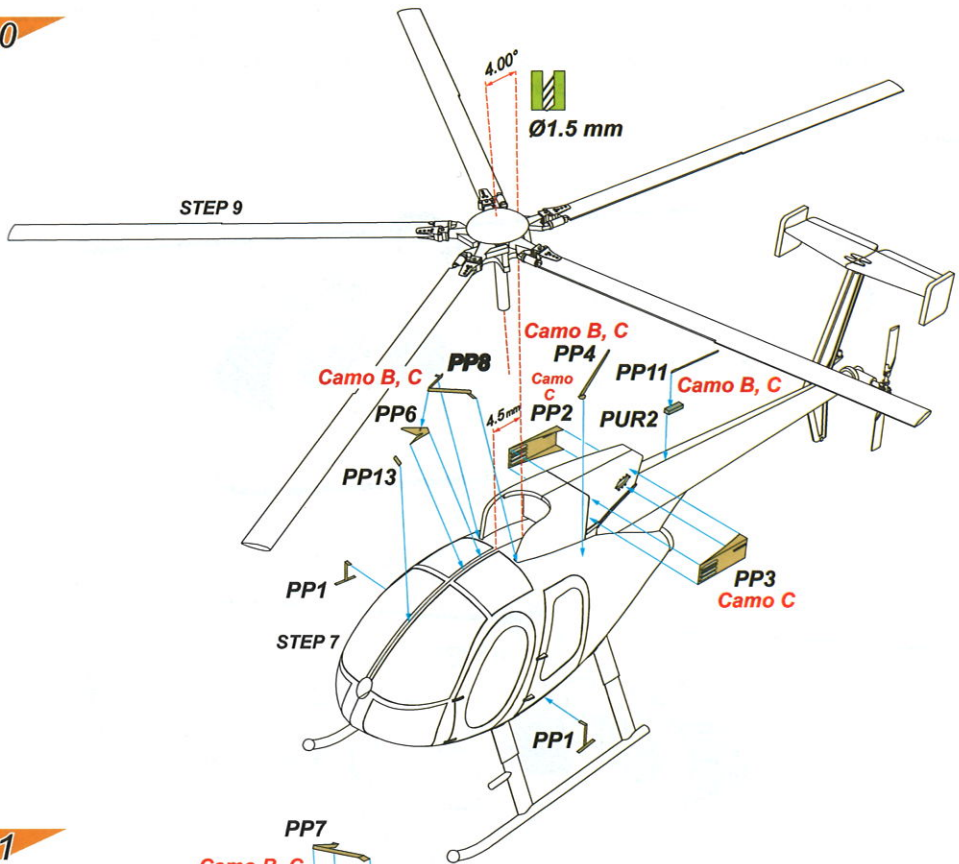

11

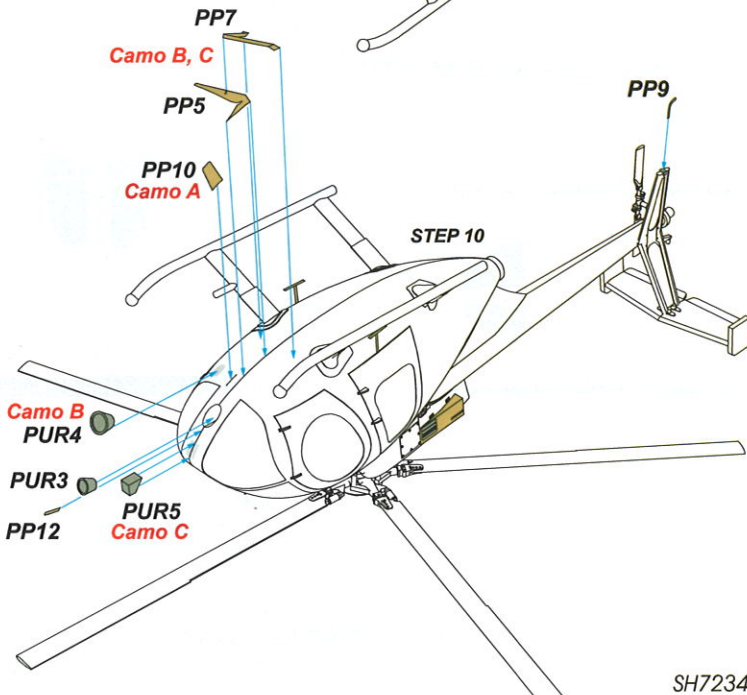

Kawasaki OH-6D, 211-8779, Japan Maritime Self Defense Force (japonské námořní síly sebeobraný). Pokud odstříhnete koncové dvojčíslí obtisku č. 19 a použijete jiné dvojčíslí, můžete postavit stroj s jiným

Kawasaki OH-6D, 2118779, Japan Maritime Self Defense Force. If you cut off the two last digits from decal no. 19 and use another two digits you will get number for another machine.

CAM. A

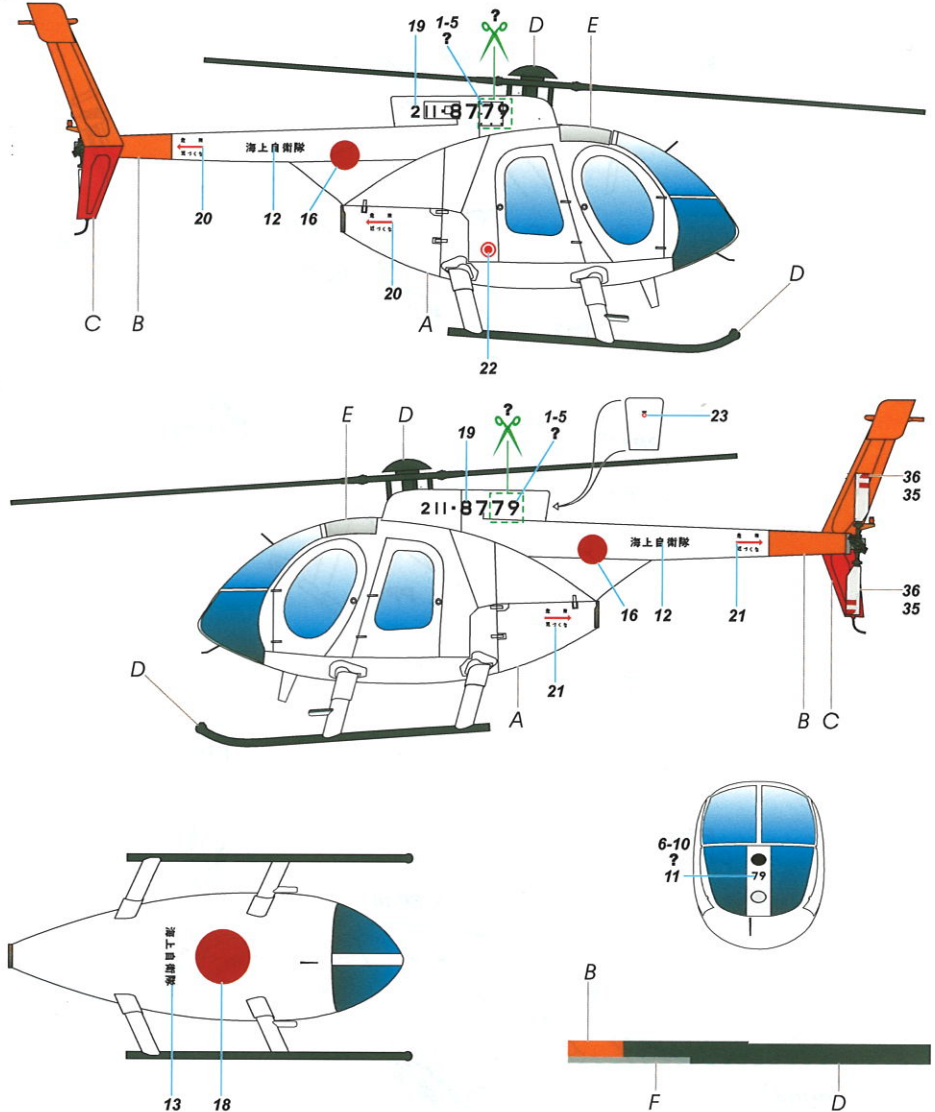

**A** Bílá  
White  
H1/ C1

**B** Signální Oranžová  
Dayglo Orange  
C173

**C** Dyaglo Red  
Signální červená  
C171

**D** Černá  
Black  
H2/ C2

**E** Kouřová  
Smoke Clear  
H95/ C101

**F** Hliník  
Aluminium  
H8/ C8

MD-500E, HH-11, Maavoimat (finská armáda). Pomocí  
obtisků postavíte i stroj HH-10. Ten je fotograficky  
doložen v letu se všemi dveřmi vymontovanými.

MD-500E, HH-11, Maavoimat (Finnish Army). You can  
build machine HH-10 with our decals. Photo reference  
show this machine in flight with all doors removed.

CAM. B

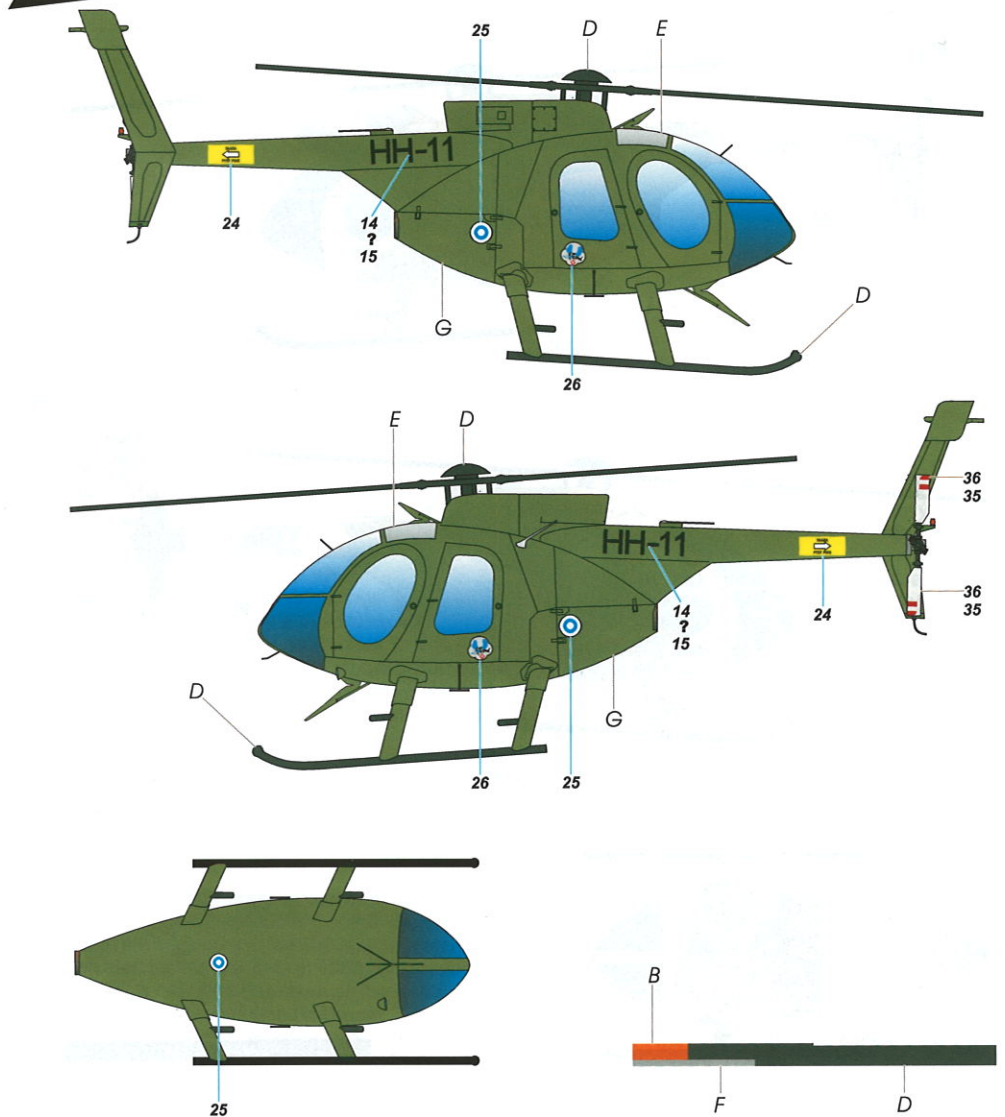

**G** Olivová zelená  
Olive Green  
H303/ C303

**B** Signální Oranžová  
Dayglo Orange  
C-173

**C** Dyaglo Red  
Signální červená  
C-171

**D** Černá  
Black  
H2/ C2

**E** Kouřová  
Smoke Clear  
H95/ C101

**F** Hliník  
Aluminium  
H8/ C8

SH72346 MD-500E

09/2016

7

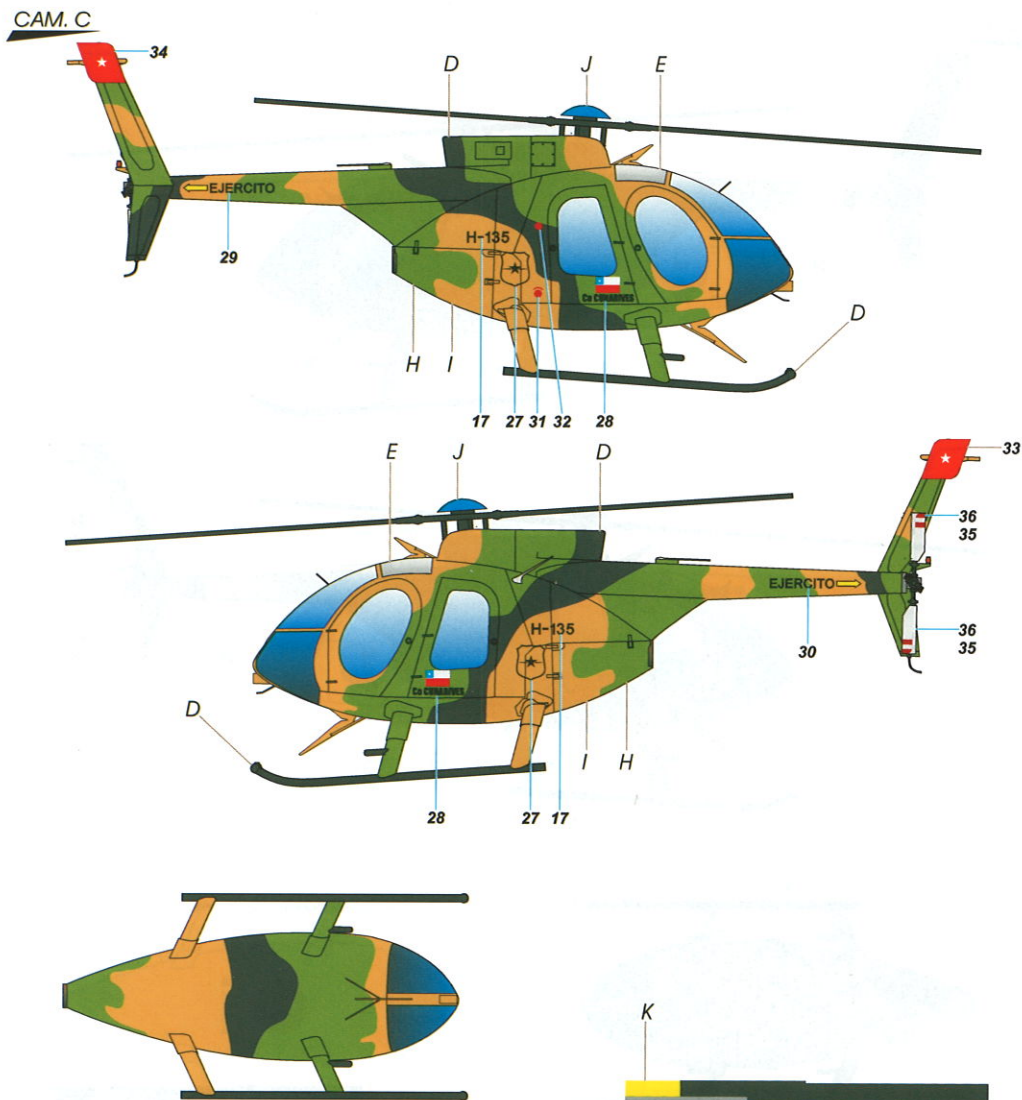

**H** Světlá zelená  
Light Green  
H312/ C312

**I** Písková  
Sand  
H27/ C44

**J** Modrá  
Blue  
H25/ C34

**K** Žlutá  
Yellow  
H4/ C4

**D** Černá  
Black  
H2/ C2

**E** Kouřová  
Smoke Clear  
H95/ C101

**F** Hliník  
Aluminium  
H8/ C8



