

Supermarine Spitfire Tr.8 and Tr.9

Plastic model
scale 1/72

History in brief

Although there were wartime conversions of the Spitfire into a two-seat trainer including the one-off modification of a Mk VC by RAF no. 261 Squadron and a Mk IX converted for use as a trainer by the Soviets, the two-seat Spitfire trainer was primarily a postwar program.

In 1946, a Mk VIII (MT818) was the first Vickers-built trainer built as a demonstrator, but in 1948, 10 Spitfire T Mk IXs, were exported to India. In 1951, a further six TR 9 trainers were converted from the standard Mk IX to train pilots for the Irish Air Corps (IAC) Seafire fleet. The Spitfires provided transition training that included gunnery practice since the type was equipped with two .303 Browning machine guns, one in each outer wing bay.

Most of the TR 9 aircraft passed to the ground technical training school at Baldonnel where they were used as instructional airframes for the training of aircraft engineers for the Air Corps.

Four of the IAC aircraft survived and two went on to join the warbird fleet in the 1970s and later.

In total, 5656 Mk IXs were built, 561 by Supermarine and 5,095 by Castle Bromwich.[22] Production of the Mk IX ended in April 1945 and, in combination with the Mk XVI this "compromise" was produced in larger numbers than any other Spitfire variant.

Armament: Irish Air Force, Indian Air Force and Netherlands Air Force
2 machine-guns 7,7 mm

Plastic parts

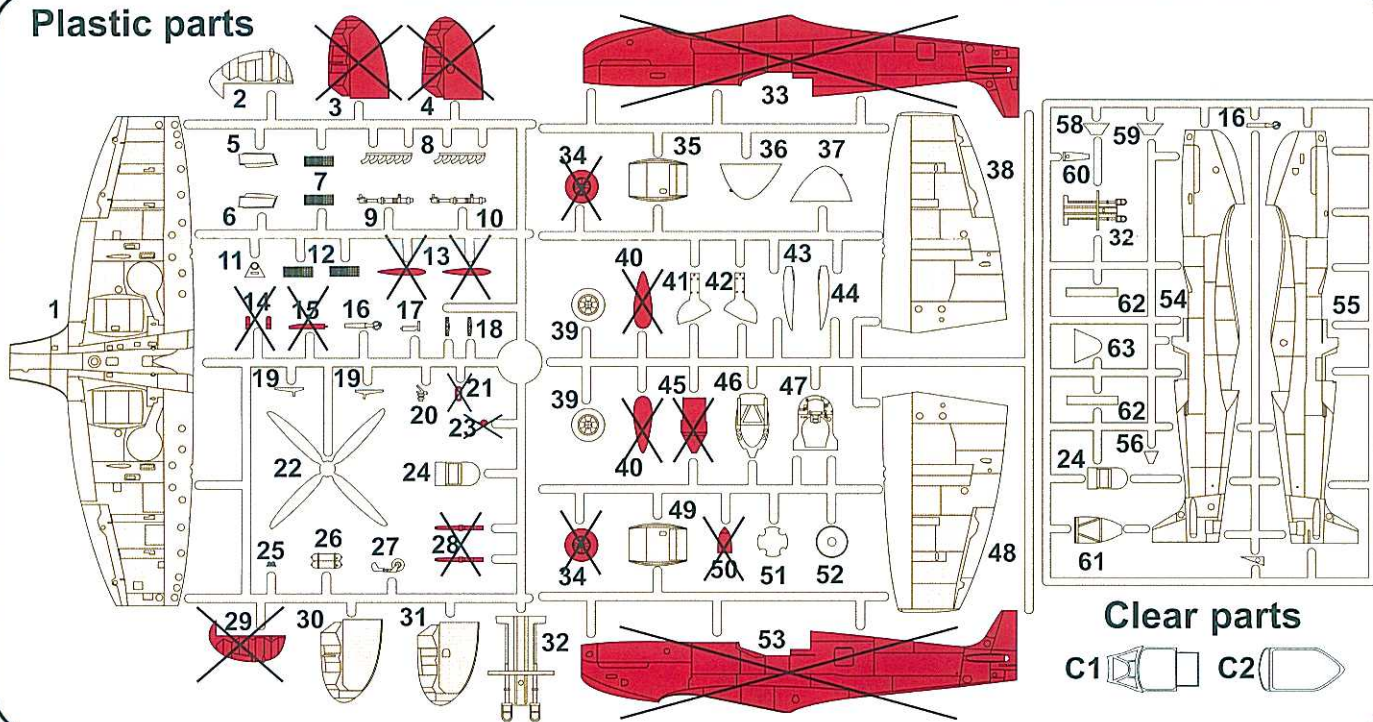

Clear parts



Symbols



Colour name	Humbrol	Colour name	Humbrol
A Black	H33	G Aluminium	H56
B White	H34	H Silver	H11
C Interior Green	H76	I Red Brown	H100
D Gunmetal	H53	J Red	H132
E Brown	H186	K Tyre	H85
F Yellow	H24	L Rust	H113

References:

SAM Publications:
The Supermarine Spitfire- A Comprehensive Guide for the Modeller: Part 1 Merlin Powered
By Eric Morgan and Edward Shacklady
Spitfire: The History
AJ-Press:
Monografie Lotnicze - Supermarine Spitfire
Internet

Assembly instructions

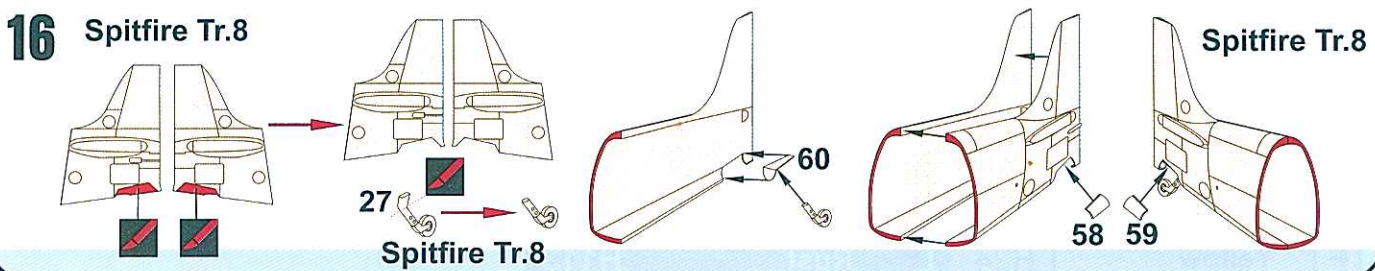
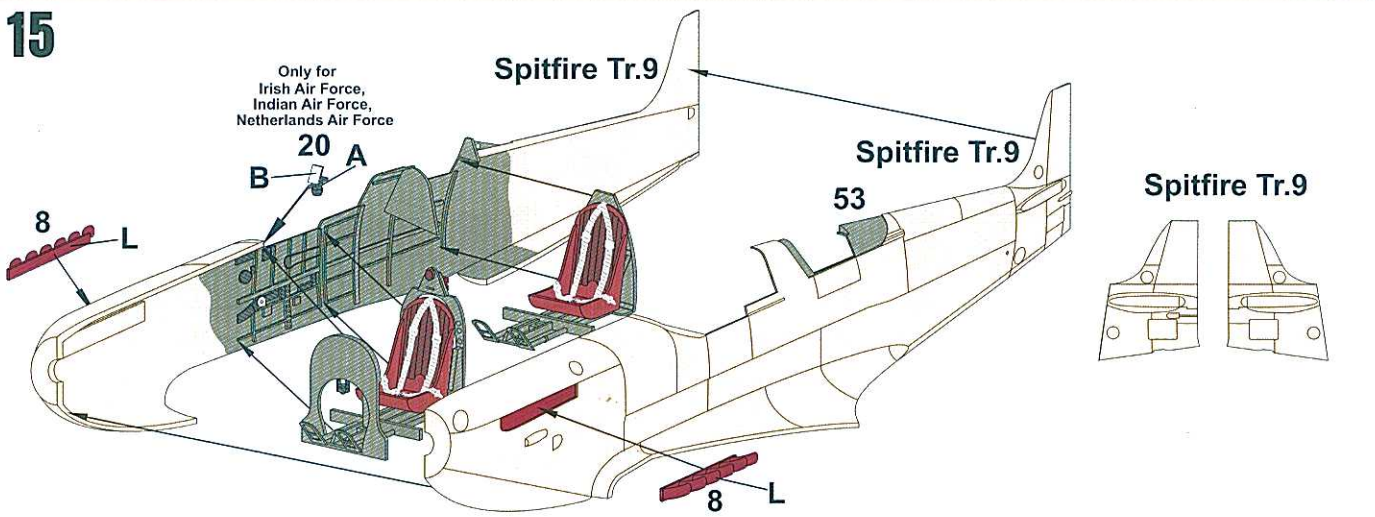
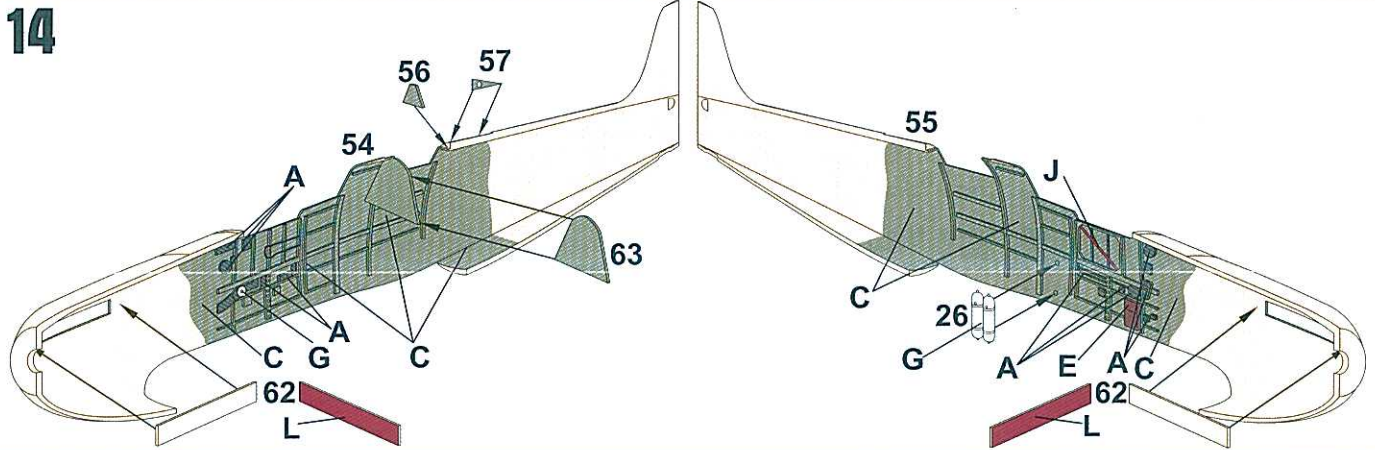
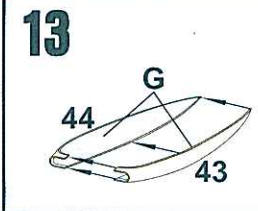
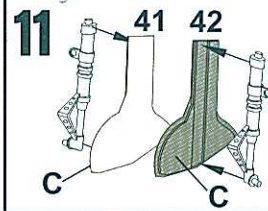
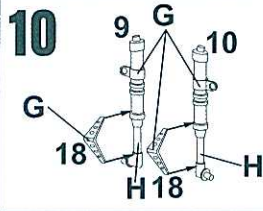
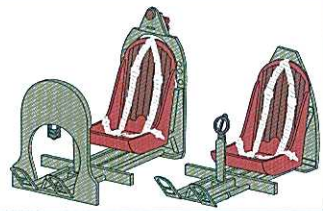
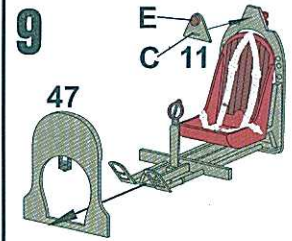
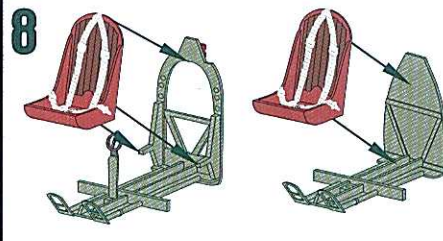
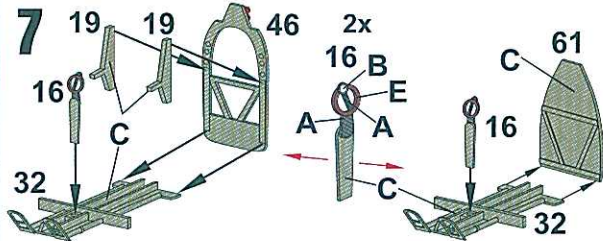
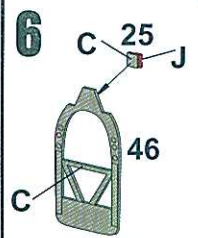
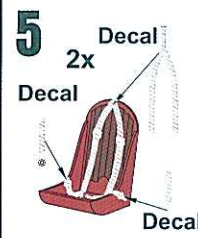
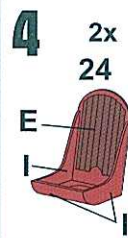
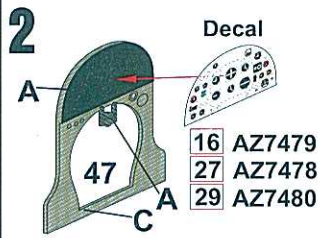
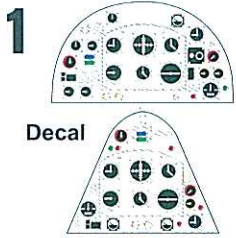

Assembly instructions

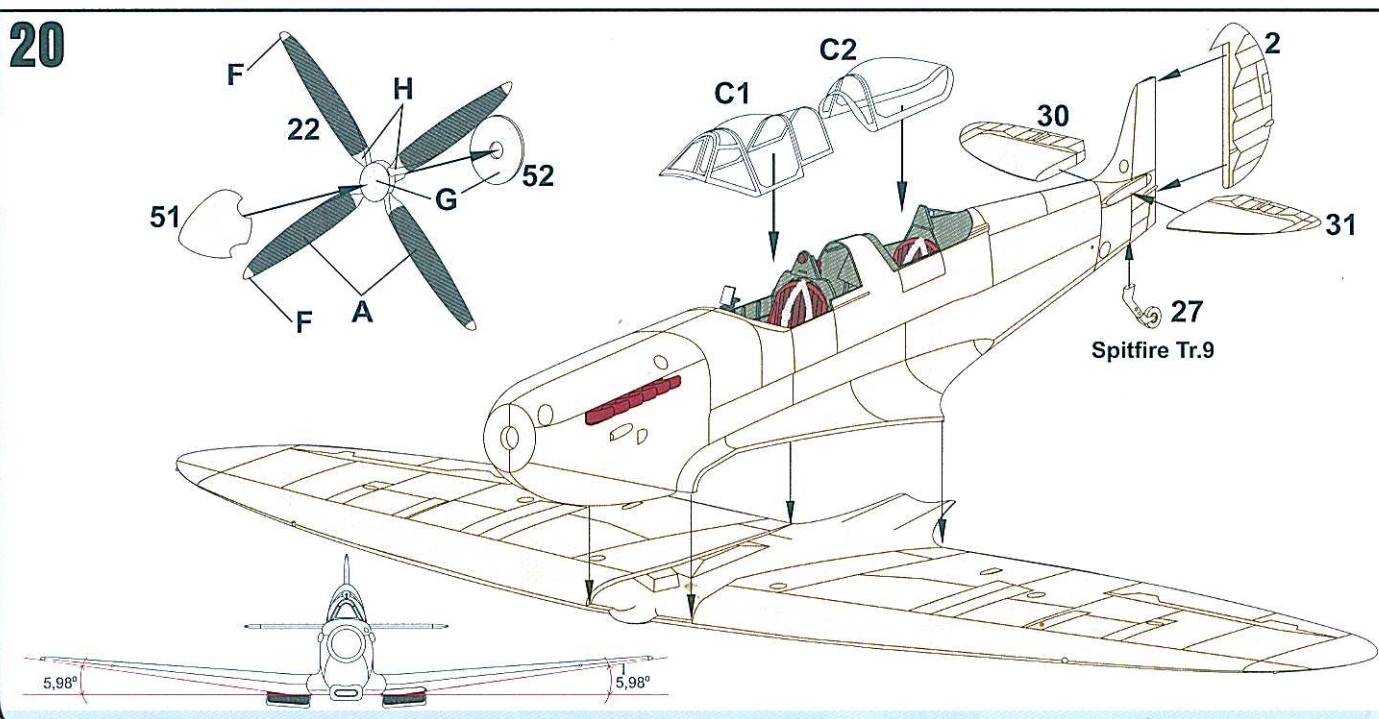
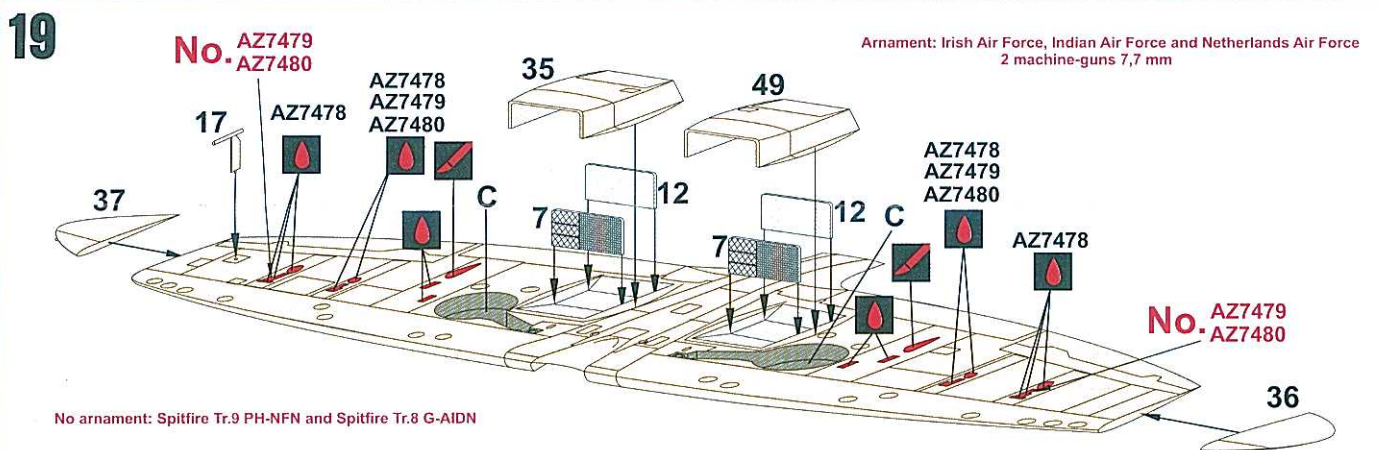
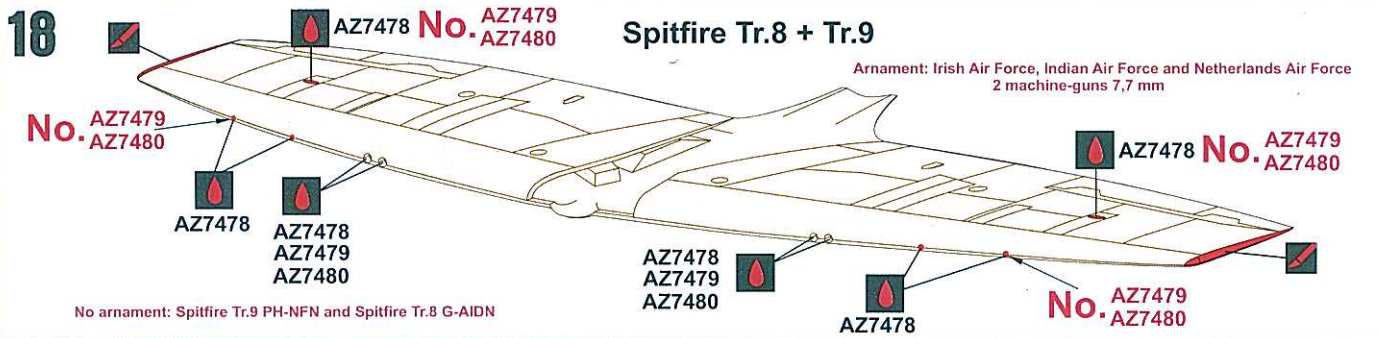
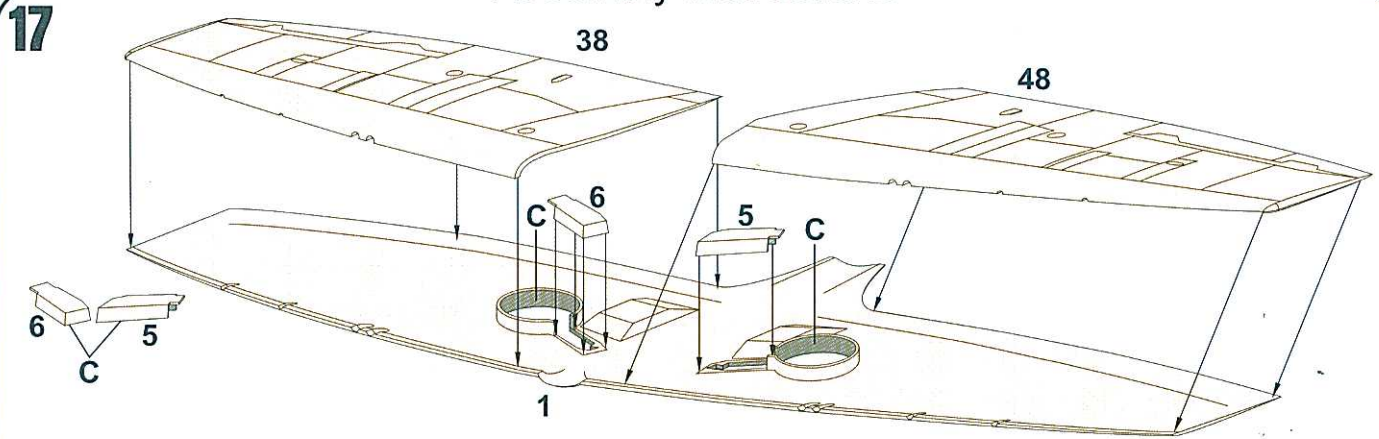

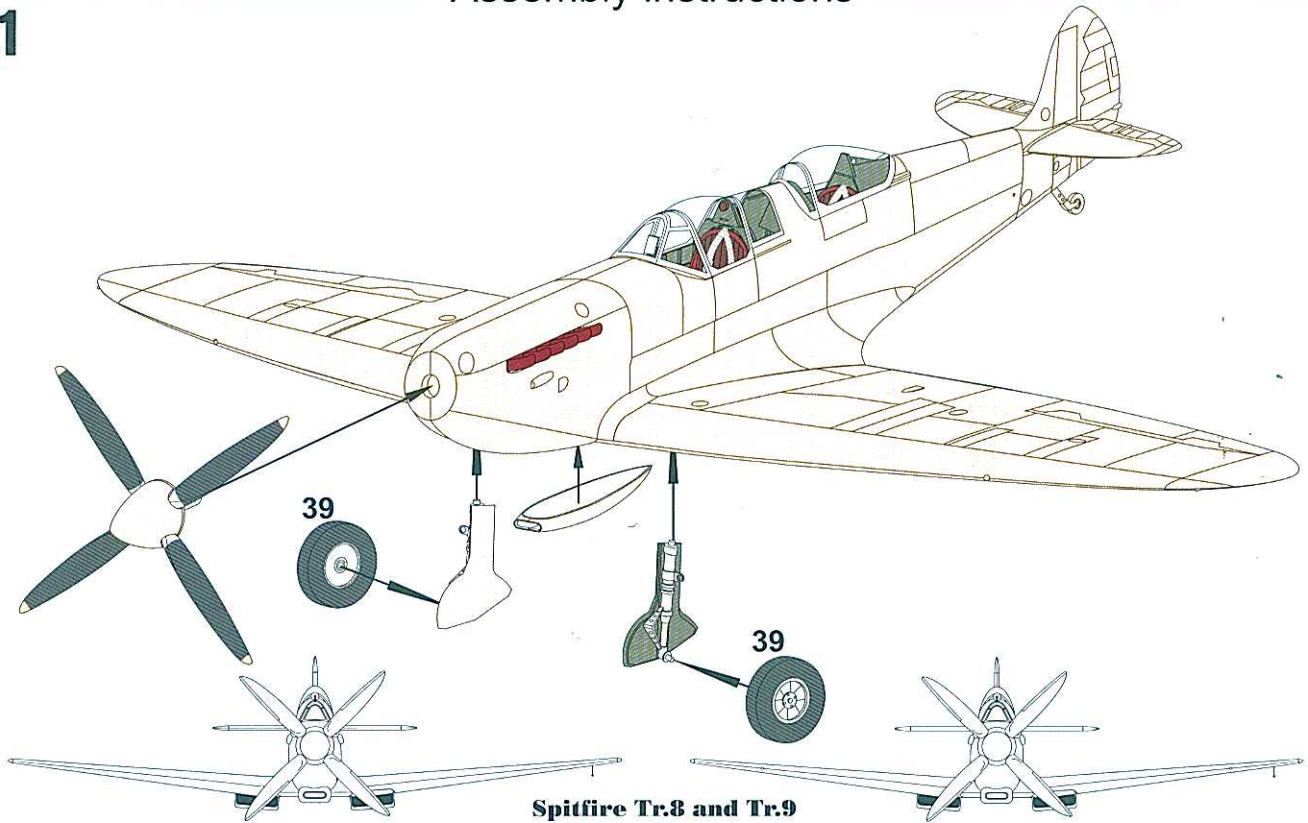

Spitfire Tr.8 and Tr.9

No ornament: Spitfire Tr.9 PH-NFN and Spitfire Tr.8 G-AIDN

Arment: Irish Air Force, Indian Air Force and Netherlands Air Force
2 machine-guns 7,7 mm

Stencils

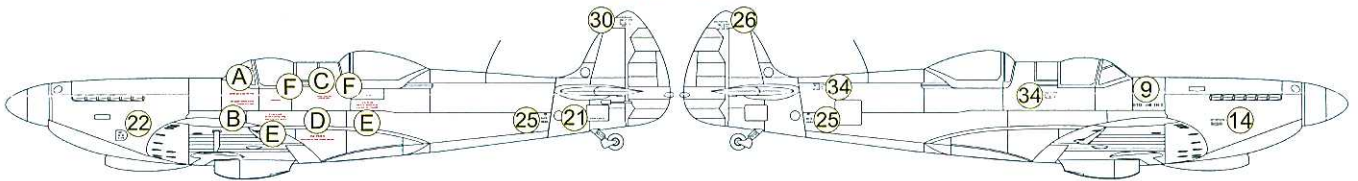

3	1	34	34
2	7		
5	4	8	
23	24	14	13
11	11	16	12
12	12	12	12
22	9	10	19
20	21	18	15
25	26	27	28
29	30	31	32
33			

Supermarine Spitfire Mk I/II stencils

Red Stencils
Royal Netherlands Air Force
H-99(BS147)
Irish Air Force 162

A	C	E	E
B	D	F	F

Black Stencils
Royal Netherlands Air Force 3Wo22
Irish Air Corps No 158
Royal Indian Air Force No.4

G	I	K	K
H	J	L	L

