

# Israeli Air Force Helicopters in the 21st Century

*CH-53 Yas'ur 2000/2025,  
H-60 Blackhawk,  
Bell 206, AH-64A Apache,  
AH-64D-I Apache Longbow  
and AH-1F Cobra.*



# IsraDecal

THE COMPLETE SCALE MODELLING EXPERIENCE

**IsraDecal**   
STUDIO

# Sikorsky CH-53 typical markings

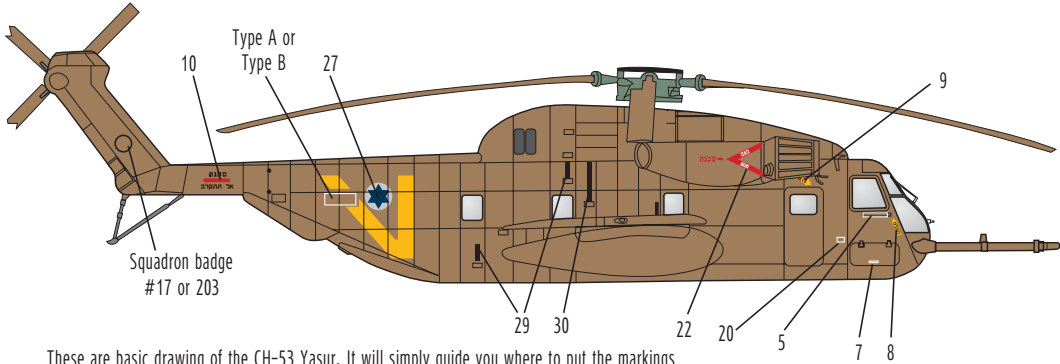

These are basic drawing of the CH-53 Yasur. It will simply guide you where to put the markings and stencils. You should check your photos to choose the helicopter you wish to model. The drawings do not includes the relevant aerials for the relevant helicopters.

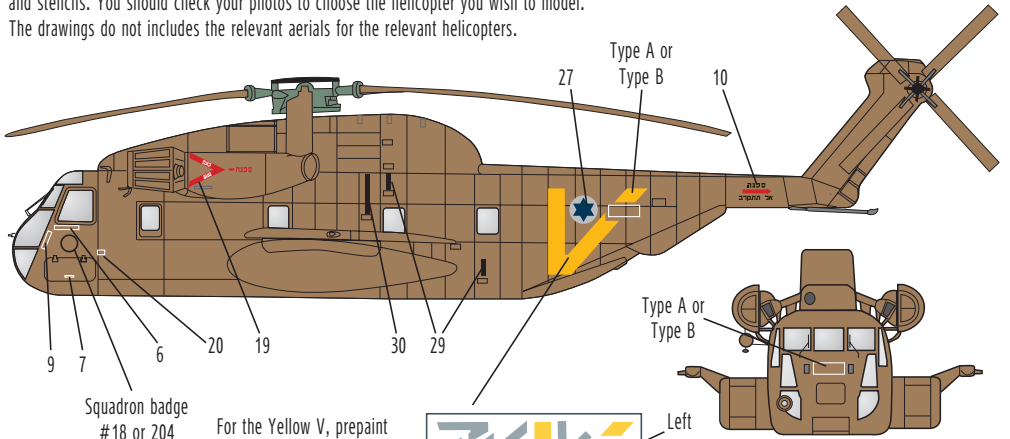

For the Yellow V, prepaint the area in Yellow FS 33538. Mask it with the precut mask provided in the set and then paint the complete helicopter in Brown FS 30145.

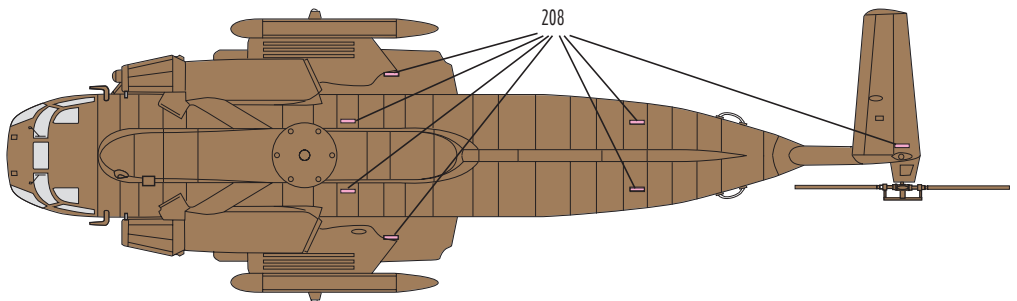

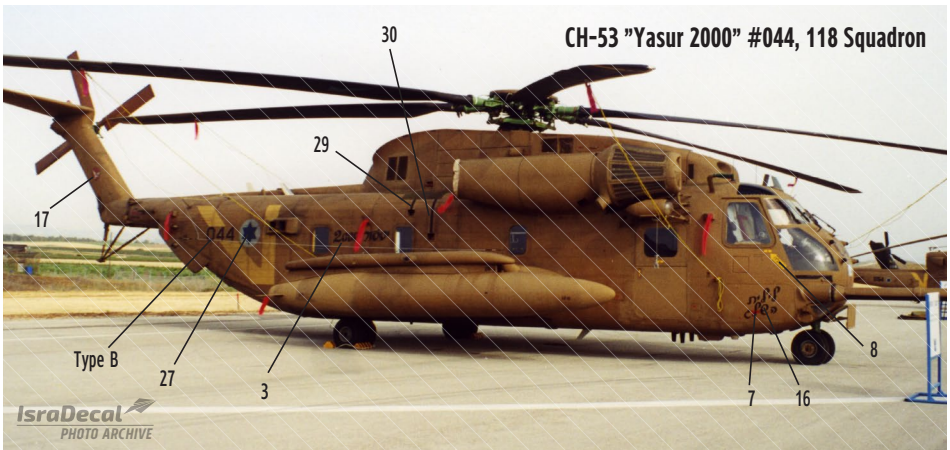





# Black Hawk Stencils

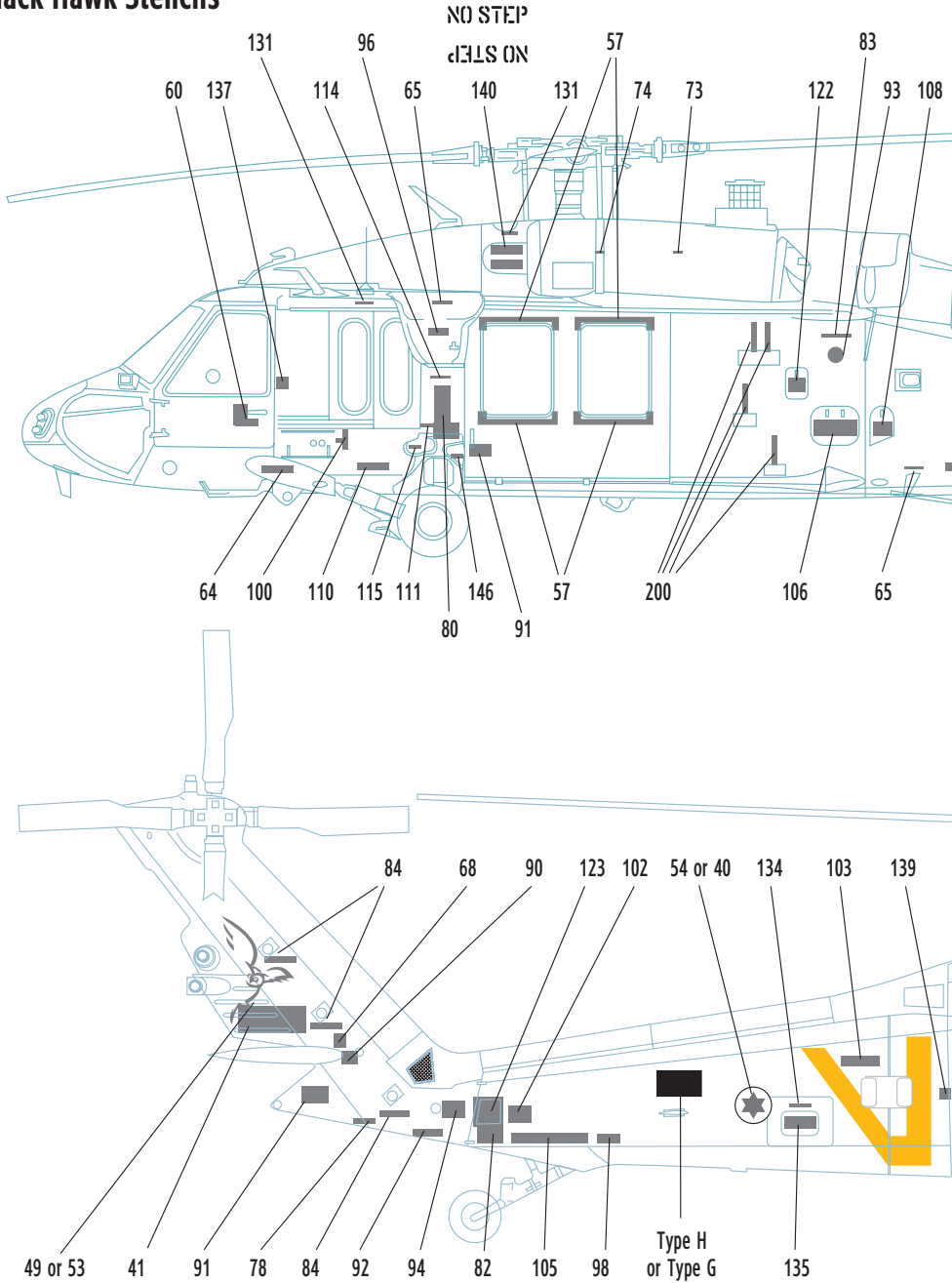

Precut mask for the Yellow V.

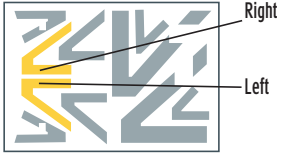
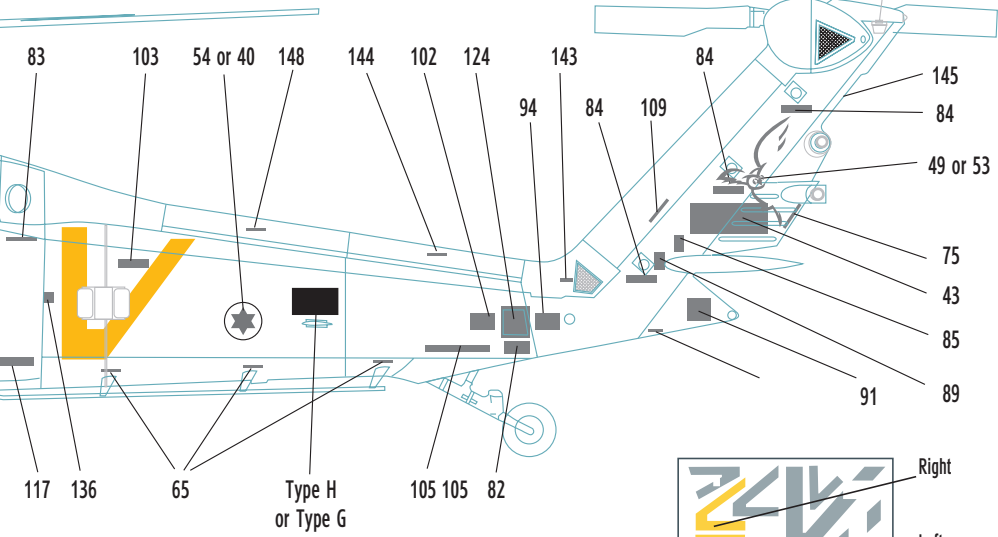

NO STEP  
ZELLE ON

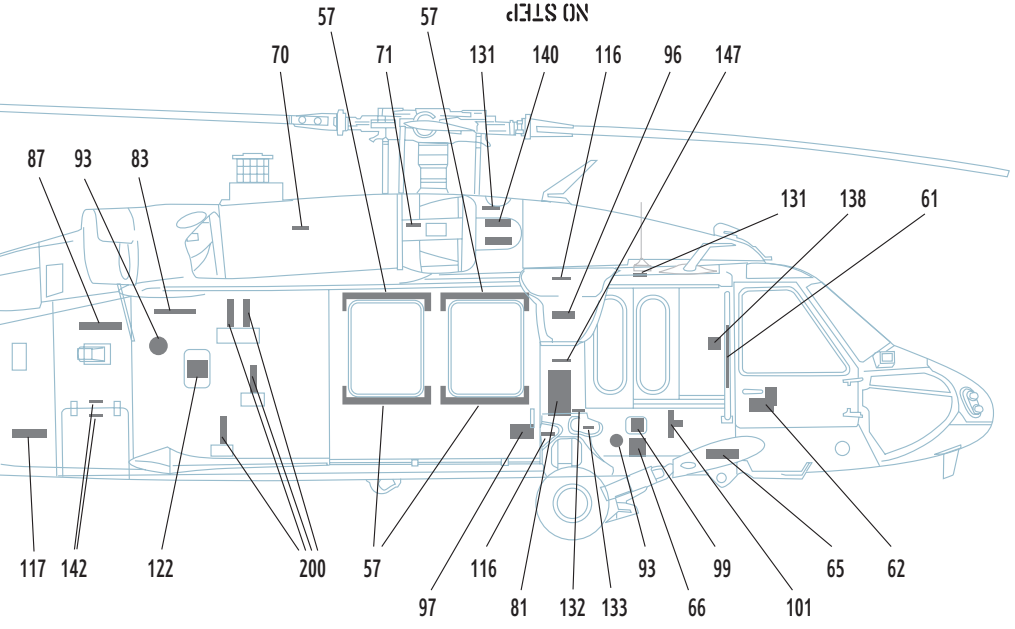

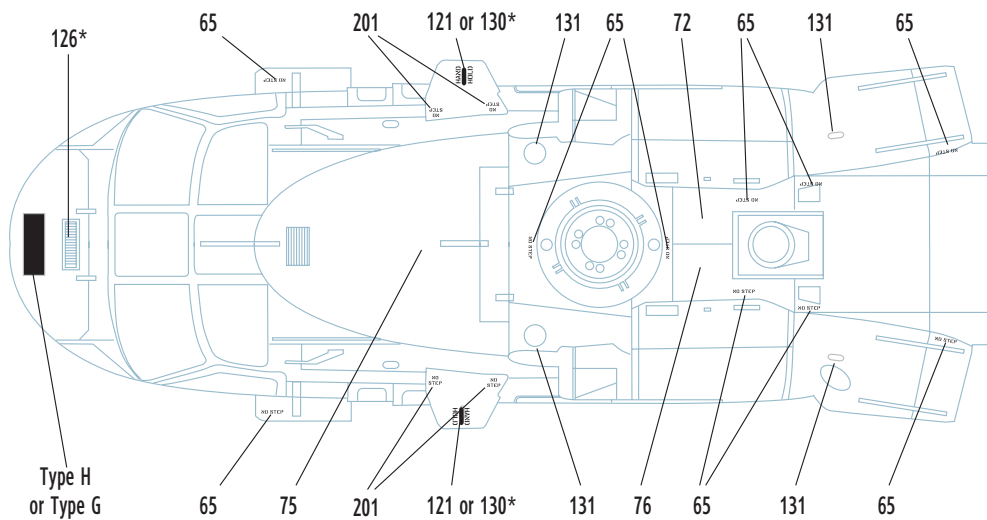

\*121 for desert color scheme. 130 for dark olive drab scheme.

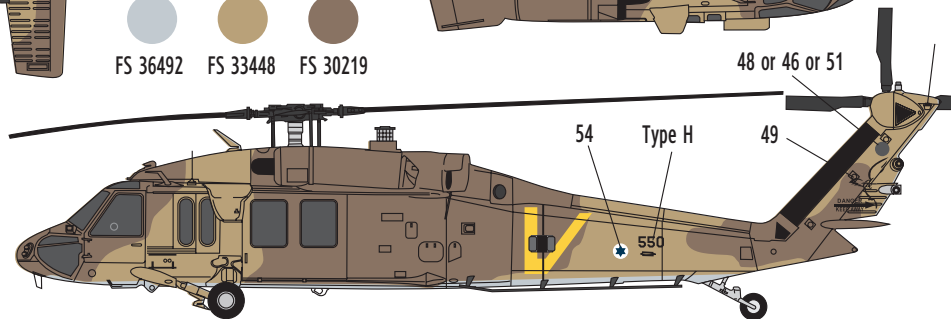
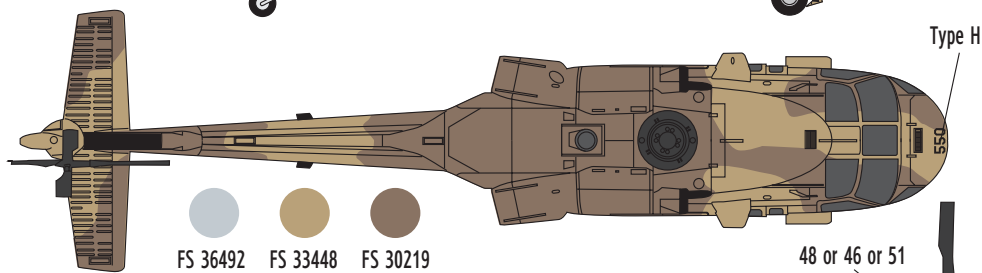
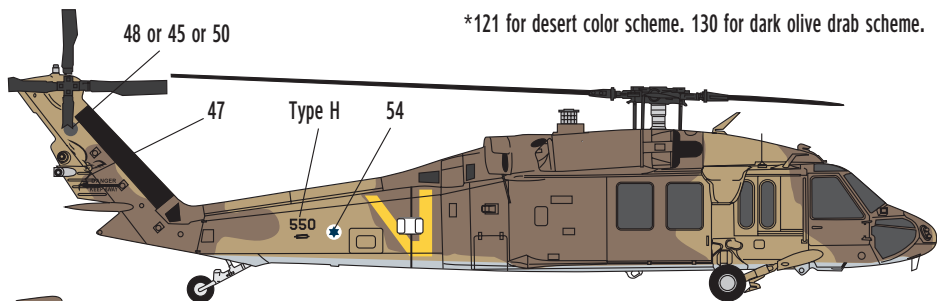



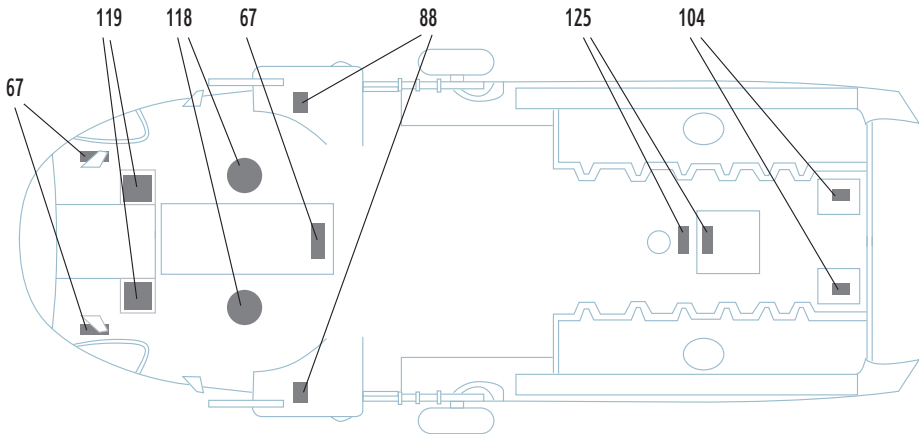
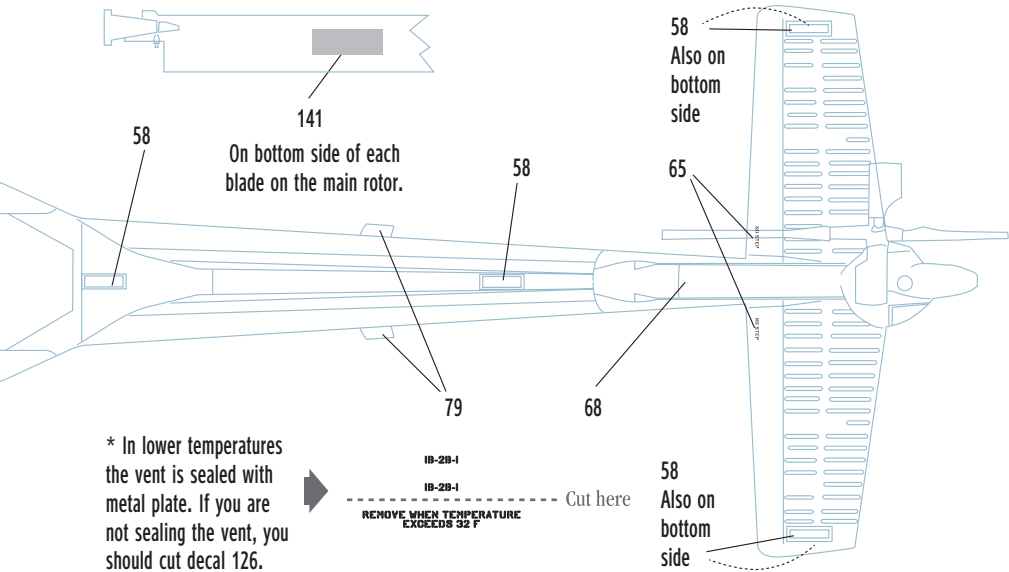

S-70 "Yanshuf 2" #934, 124 Squadron



S-70 "Yanshuf 2" #840, 124 Squadron



H-60L "Yanshuf 3" #536, 123 Squadron



H-60L "Yanshuf 3" #559, 123 Squadron



IsraDecal  
PHOTO ARCHIVE

H-60L "Yanshuf 3" #575, 124 Squadron



IsraDecal  
PHOTO ARCHIVE

H-60L "Yanshuf 3" #571, 124 Squadron



Yissachar Ruas©

AH-64A "Peten" #840, 190 Squadron

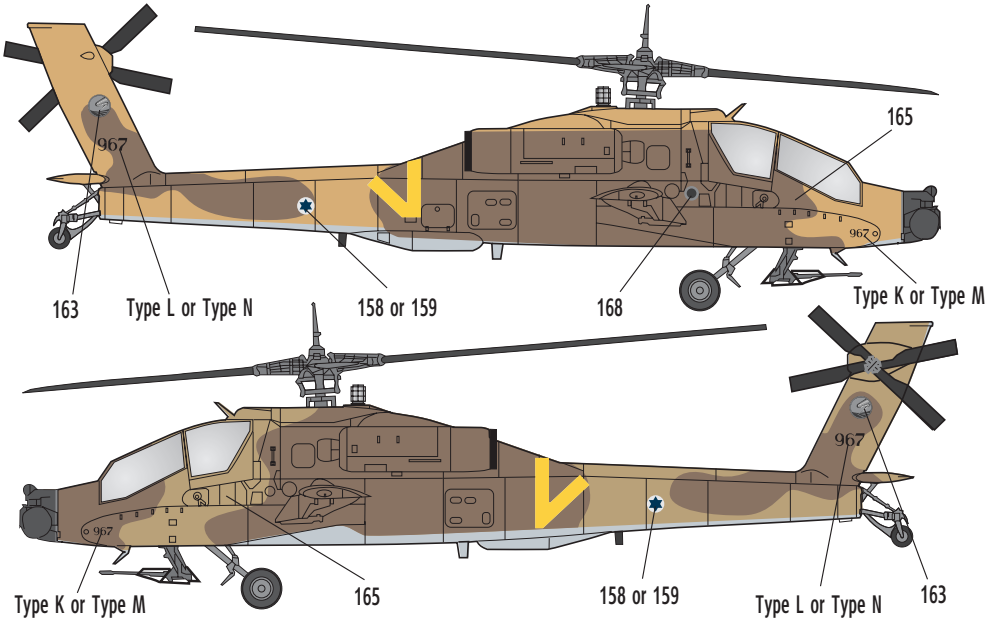

Top view

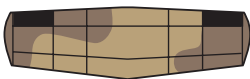

Bottom view

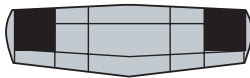

External fuel tank

Top view

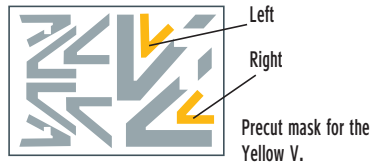

AH-64A "Peten" #966, 190 Squadron

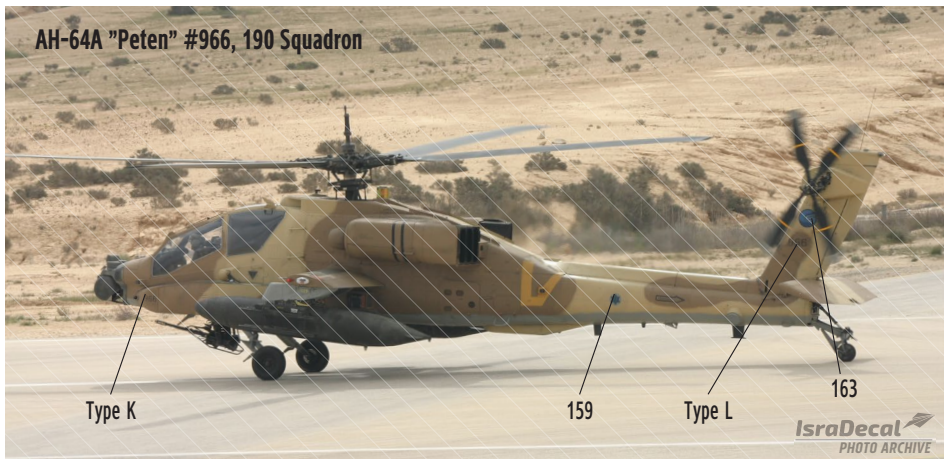

AH-64A "Peten Matrix" #820, 190 Squadron



AH-64A "Peten Matrix" #812, 190 Squadron



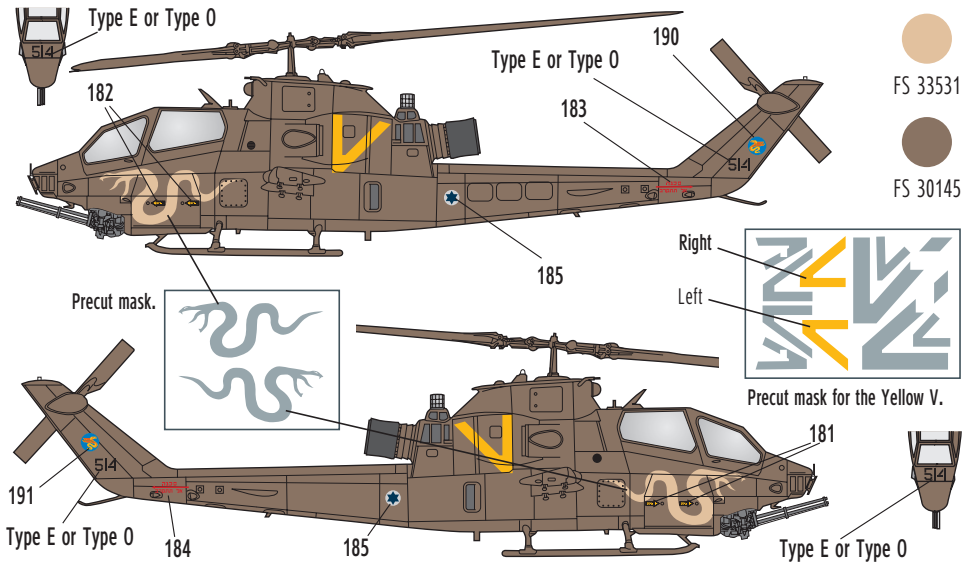
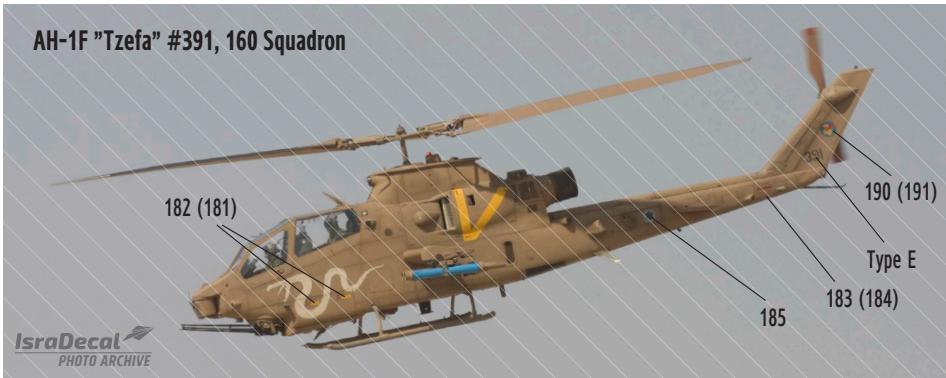

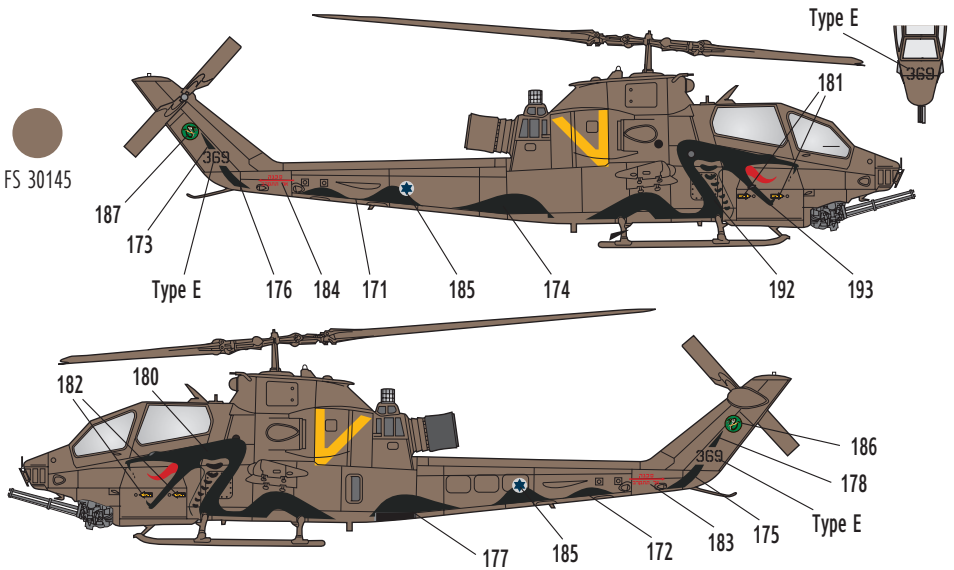
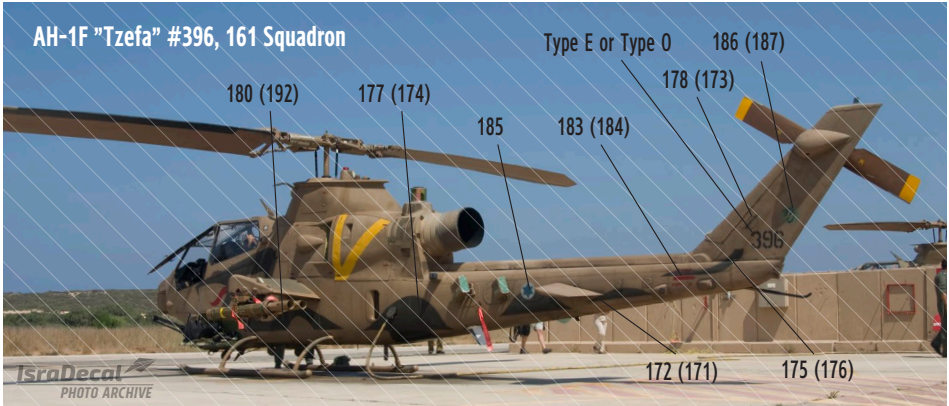

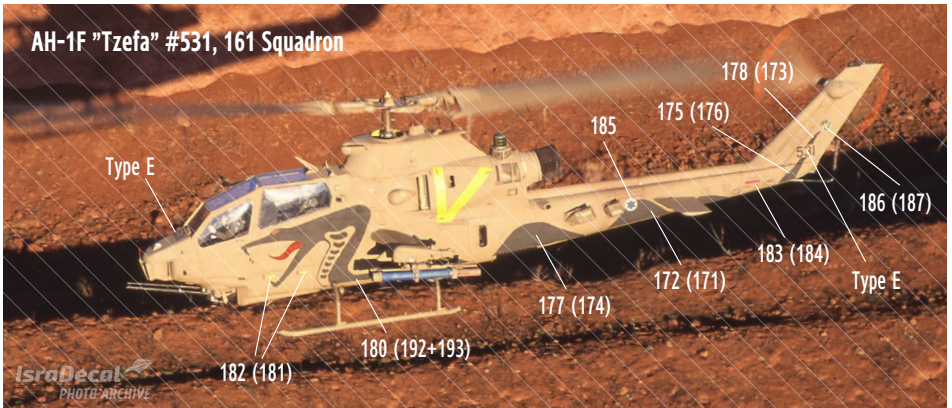





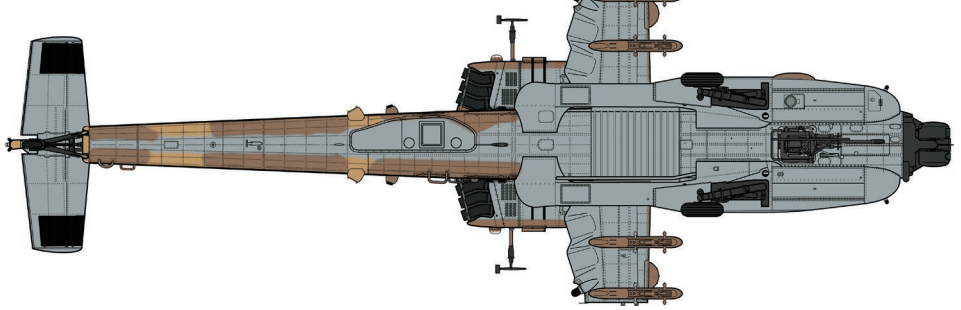
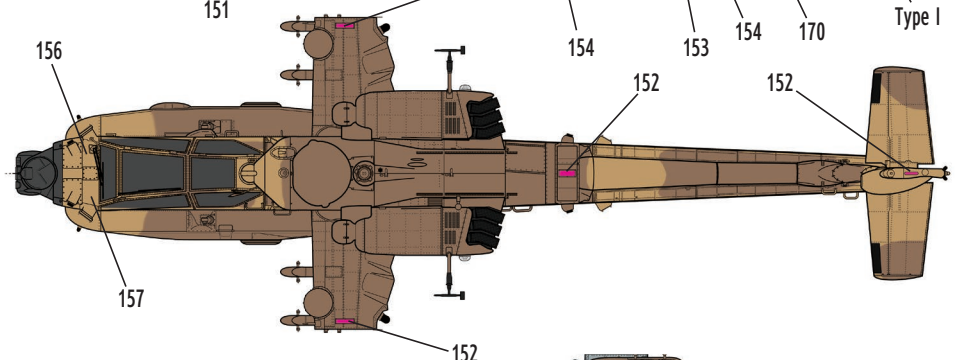
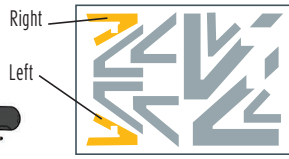
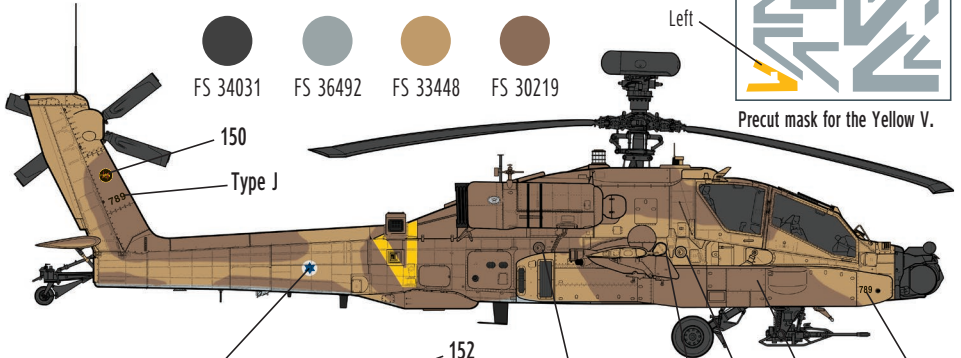
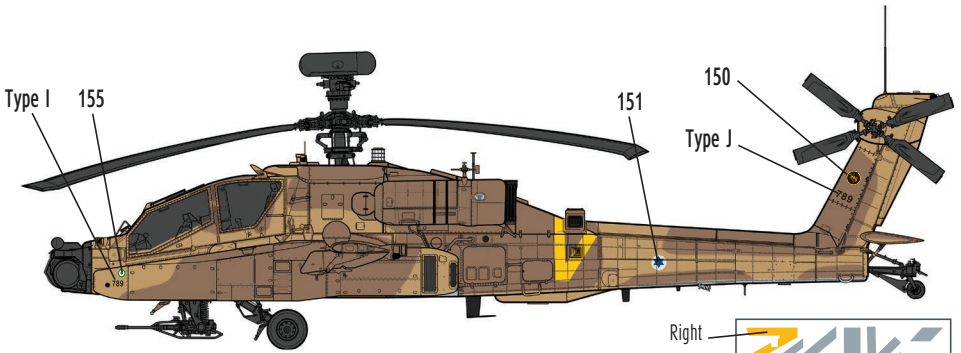

AH-64D-I "Saraf" #752, 113 Squadron

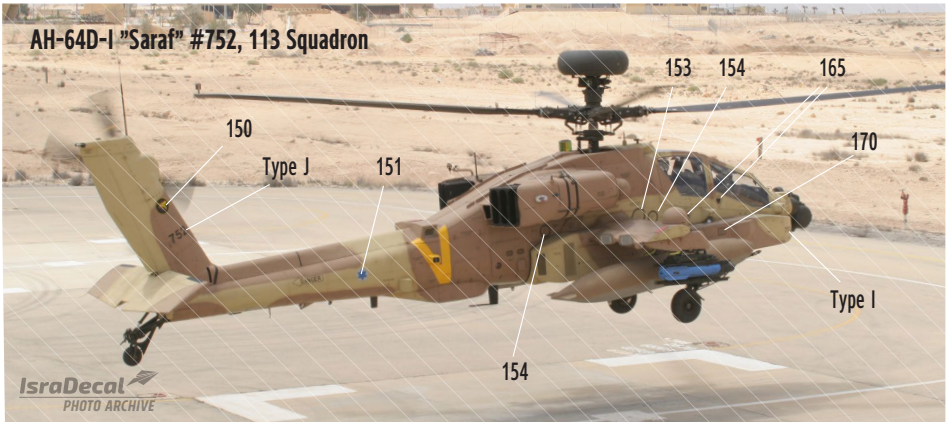

AH-64D-I "Saraf" #726, 113 Squadron



AH-64D-I "Saraf" #779, 113 Squadron



OH-58A "Sayfan" #134, 125 Squadron

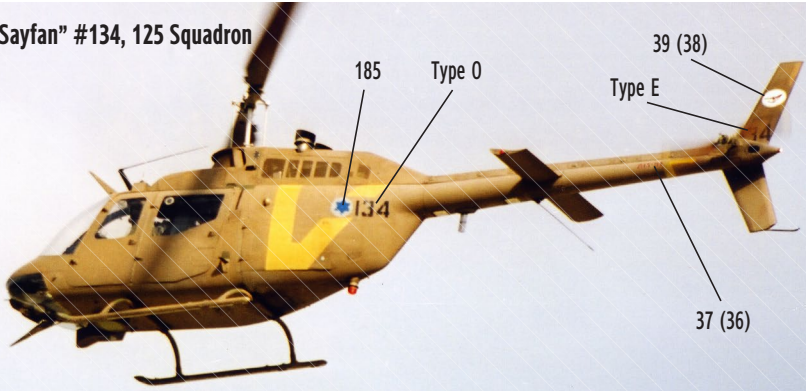

IsraDecal  
PHOTO ARCHIVE

Bell 206 "Sayfan" #019, 125 Squadron



IsraDecal  
PHOTO ARCHIVE

On early 2000's the Bell 206/ OH-58A "Sayfan" were on their last years on operational duty. The traditional yellow badge was replaced to a white one. The precut mask does not include the mask for the Bell 206's Yellow V. Below we provide the measurements of it in 1/48 scale. Helicopters are painted in FS 30145 Brown.

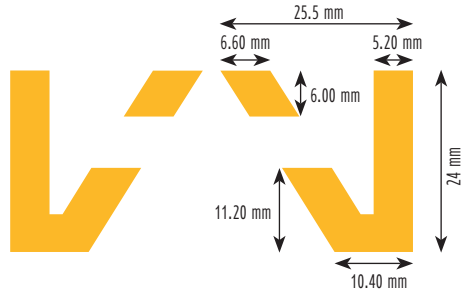

OH-58A "Sayfan" #138, Flight Academy

IsraDecal  
PHOTO ARCHIVE



Photo: Shay Finkelman ©



OH-58A "Sayfan" #130, Flight Academy

Photo: Shay Finkelman ©

The Bell 206 / OH-58A ended their operational service in 2003 and remained in service with the IAF Flight Academy. Serving there brought to repaint the helicopters as a trainer in the colors of White and Red FS 11136. Paint first the glossy white and use the photos on this page and the next one to see how to mask the paint the red color.



Photo: Shay Finkelman ©



OH-58A "Sayfan" #130, Flight Academy

Photo: Shay Finkelman ©

**OH-58A "Sayfan" #145, Flight Academy**

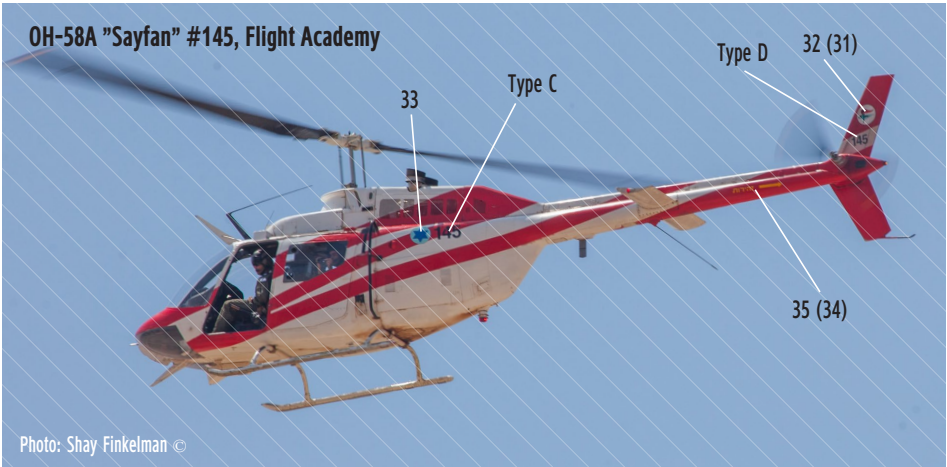

Photo: Shay Finkelman ©

**OH-58A "Sayfan" #125, Flight Academy**



Photo: Shay Finkelman ©

**OH-58A "Sayfan" #130, Flight Academy**



Photo: Shay Finkelman ©