

## US M26 with 90mm T15E2M2

美国M26坦克-90mm T15E2M2炮管

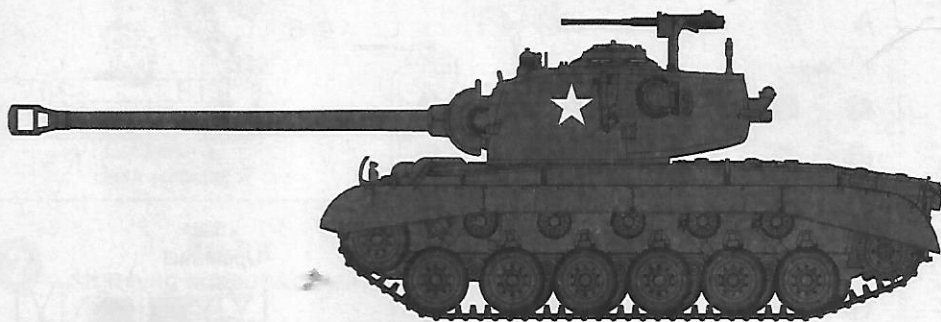

## READ BEFORE ASSEMBLY:

- Study and understand these instructions thoroughly before beginning assembly
- When needed, remove photo-etch parts carefully using a modeling knife or photo etch sprue cutter, being careful not to damage or lose small parts.
- Take extra care in handling photo etch parts in order to avoid injury
- Apply instant cement sparingly to photo etch parts where instructed
- Tools recommended(not included in kit):Plastic and instant cements,sprue cutters,long nose pliers,,modeling knife, small files, tweezers, pin vise & scissors. Soft cloth and sandpaper will also assist in construction
- Glue and paint are not included in the kit. Use plastic cement and hobby paints only. Color guide for purchasing paint is included in the kit.

## 装配之前仔细阅读

- 小心用模型锉刀锉平所有零件表面的注射浇口。
- 小心用刀片切下蚀刻片零件，不要遗失小零件。
- 用强力快干胶水粘合蚀刻片零件和金属轴。过量的快干胶水使用可能导致可动零件会粘住，小心涂胶。
- 取蚀刻片时应特别注意安全，防止利边划伤手指。
- 某些零件表面需贴水上贴纸，请选择在装配的同时进行。
- 推荐模型工具(自备)：胶水，水口剪刀，长咀钳，刀片，锉刀，镊子，钳，钻，剪刀，瞬间快干胶。
- 软布同砂纸同时也应该是必备工具。
- 请使用塑料胶水和油漆，模型内不含。



使用强力胶

Cyanoacrylate glue



配重

Weight



钻孔

Make hole



切除

Cut / Remove



贴纸

Decal



锉平

File / Sand



选择

Option



不涂胶水

No cement



弯曲

Bend



先装

Install it first

## 水贴纸的使用:

1. 从水贴纸上剪下印花;
2. 将印花放入温水中浸10秒, 然后放在干净布上。
3. 拿着印花纸板将印花移到模型上;
4. 手指蘸水将印花移到适当的位置;
5. 用软布轻压印花直至水干, 气泡消失。

## DECAL APPLICATION

1. Cut off decal from sheet.
2. Dip the decal in tepid water 40°C for about 10 sec. and place on a clean cloth.
3. Hold the backing sheet edge and slide decal onto the model.
4. Move decal into position by wetting decal with finger.
5. Press decal gently down with a soft cloth until excess water and air bubbles are gone.
6. Allow decal to dry completely before handling model.

# 部品图 Parts

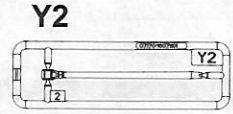
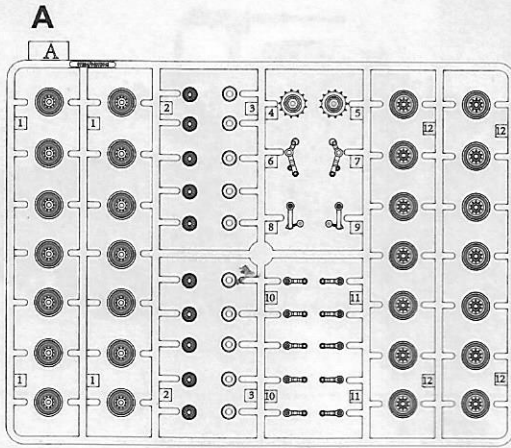

《车面》  
Upper hull

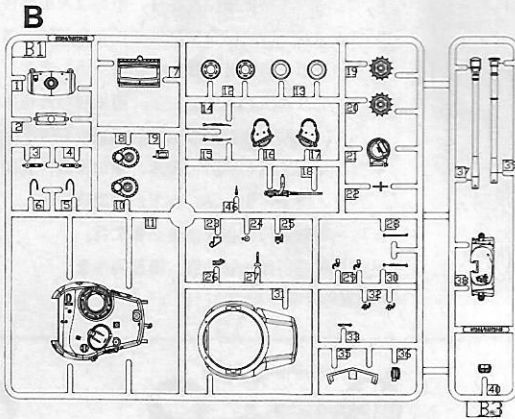
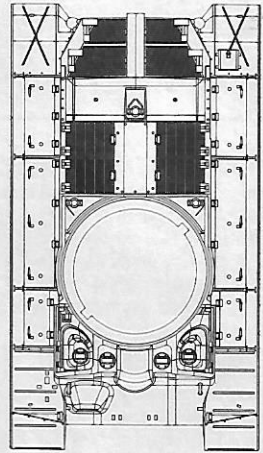

《车底》  
Lower hull

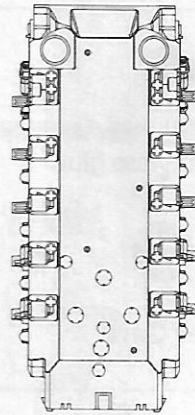

《底座》  
Stand

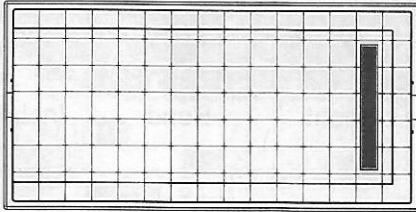

《履带》  
Track X2



《水贴》  
Decal



**07170 1/72 US M26  
with 90mm T15E2M2**

1

车轮组装  
Wheels assembly

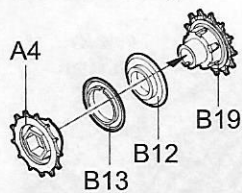

《主动轮R》  
Dirve sprocket R

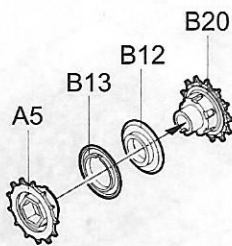

《主动轮L》  
Dirve sprocket L

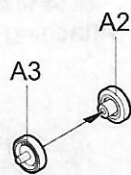

《拖带轮》  
Support roller  
制作10组  
Make Ten

2

悬挂安装  
Attaching suspension arme

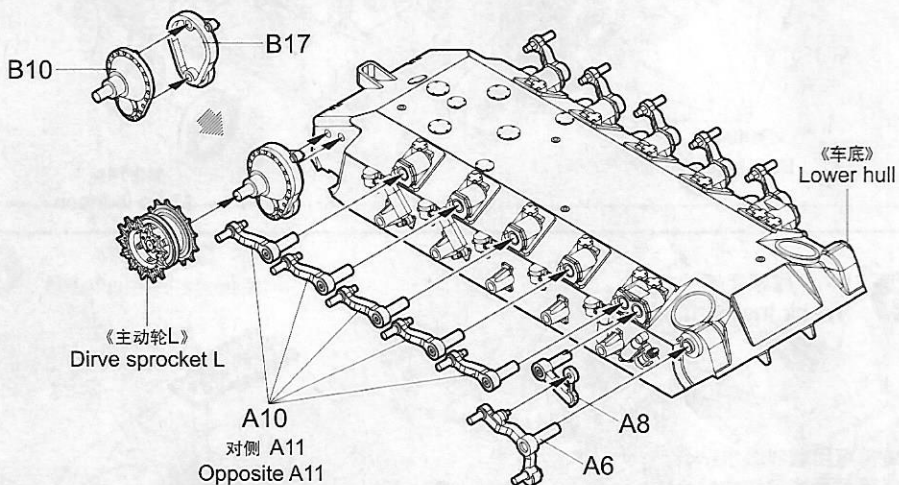

3

悬挂安装  
Attaching suspension arme

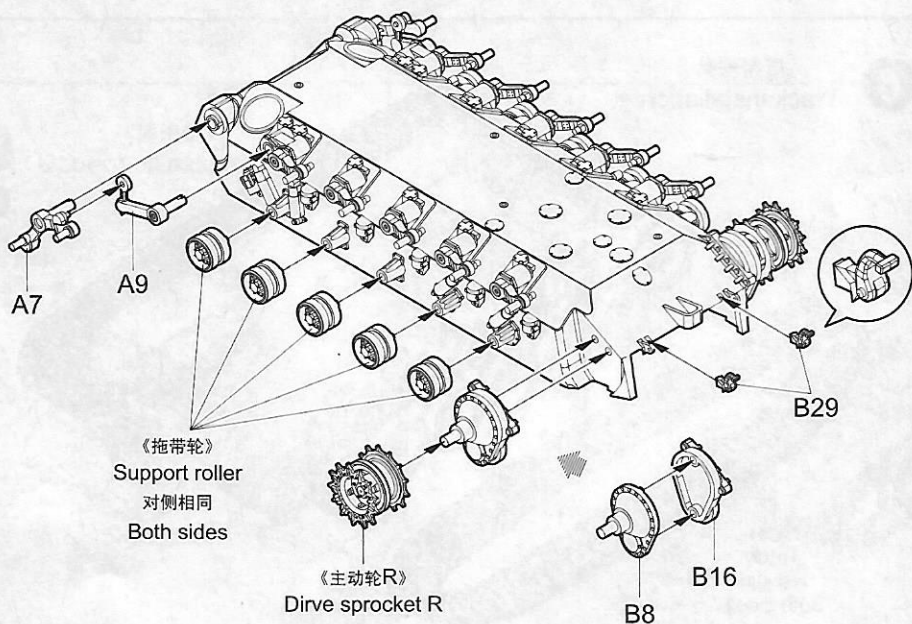

**4** 车轮安装  
Attaching wheels

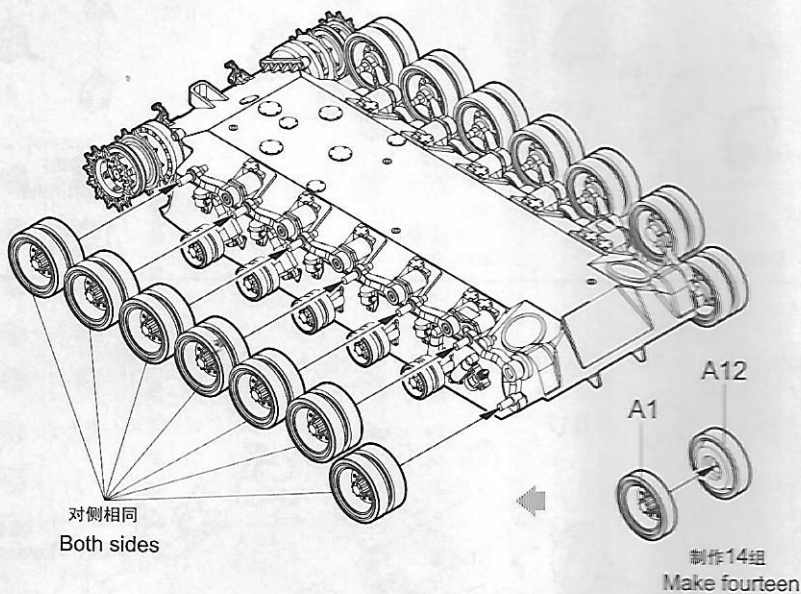

**5** 履带连接  
Track installation

- \*履带可用塑料胶水粘合
- \*履带可用模型胶水粘合
- \*若履带断裂，用细线固定
- \*The tracks in this kit can be glued using plastic cement.
- \*The tracks can be painted using plastic panints.
- \*If track is broken strengthen with staples or thread.

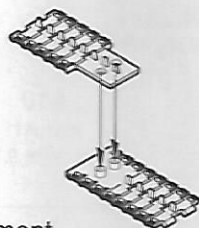

**6** 履带安装  
Track installation

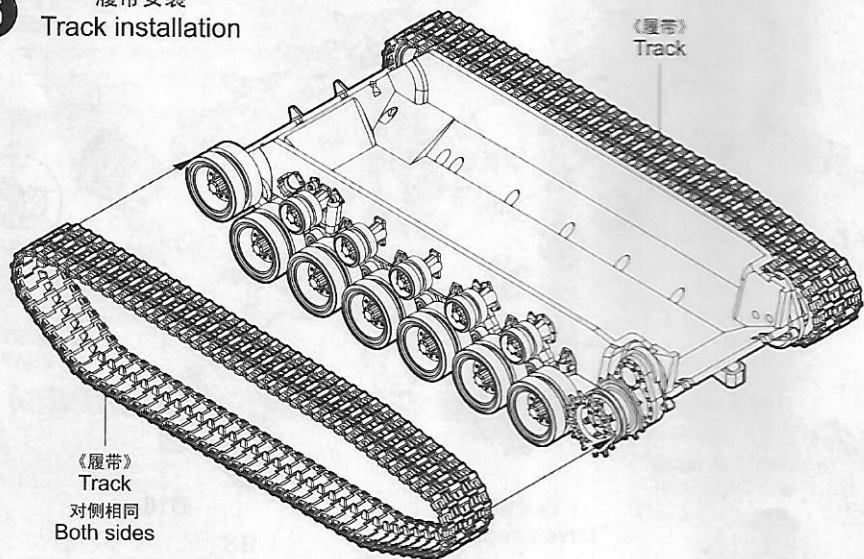



7

车面安装  
Upper hull installation

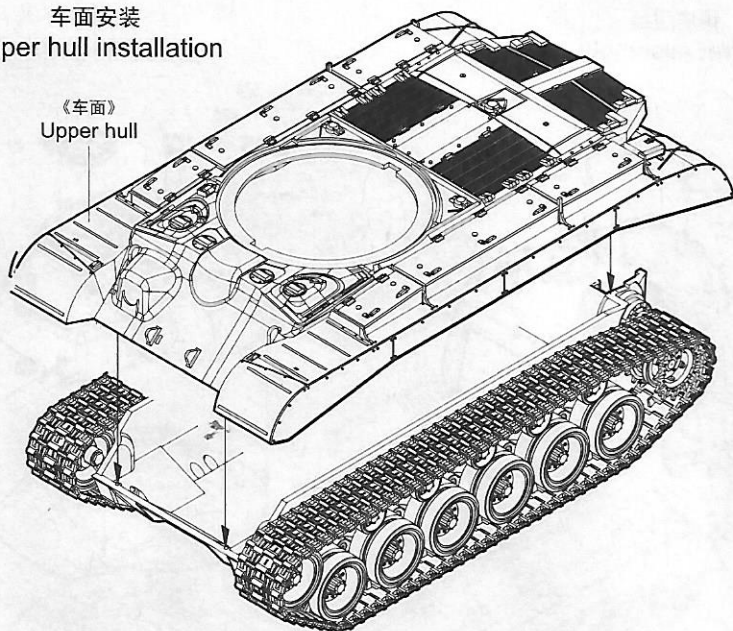

8

后板组装  
Rear panel assembly

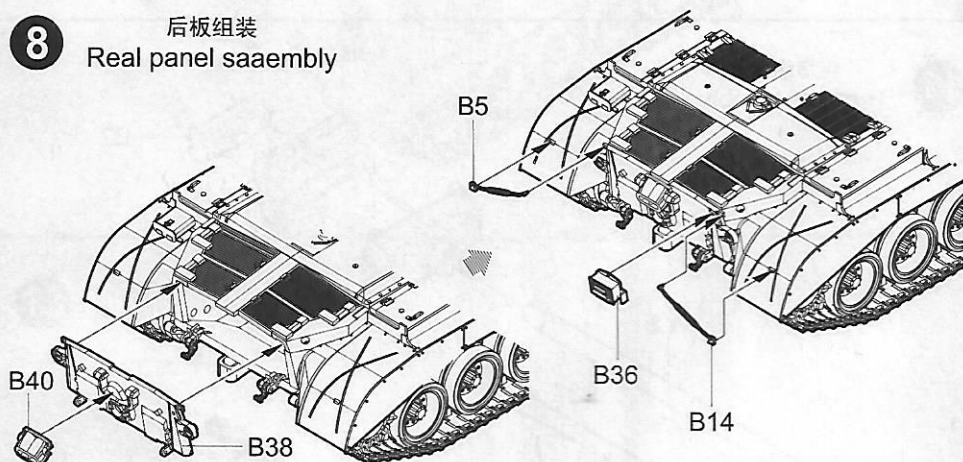

9

车面组装  
Upper hull assembly

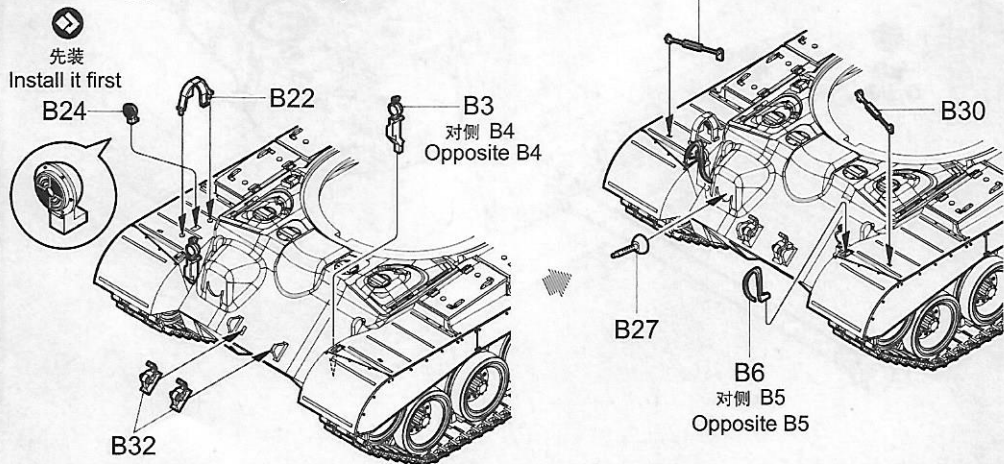

**10**

炮塔组装  
Turret assembly

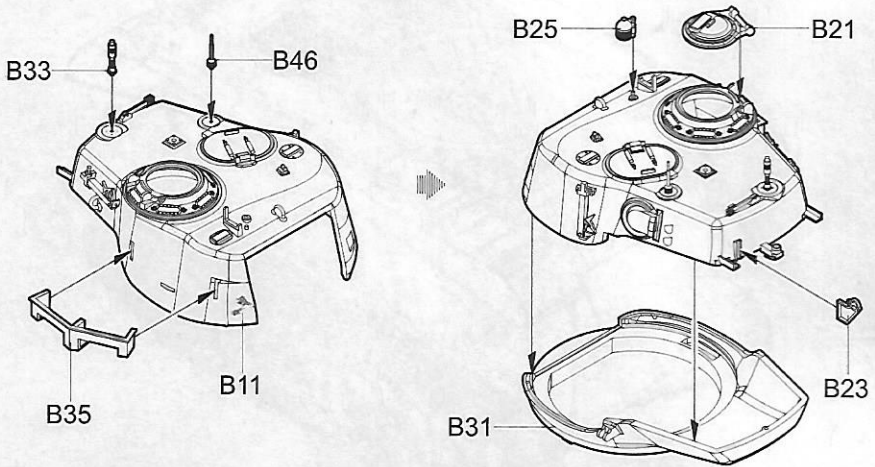
**11**

炮塔组装  
Turret assembly

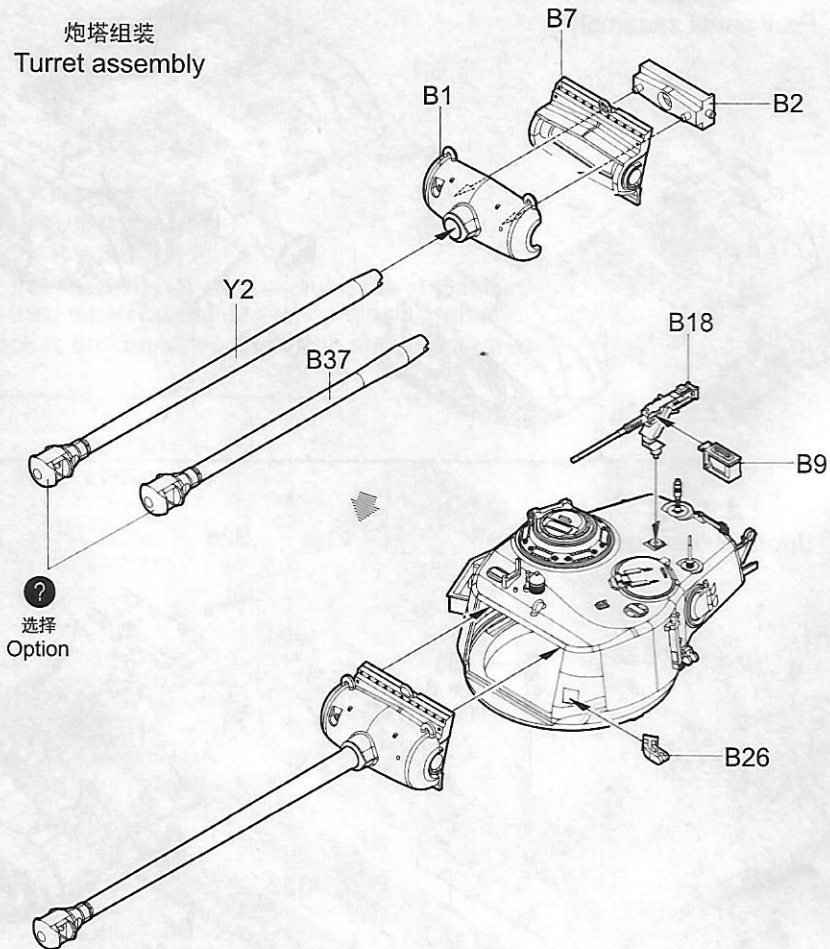

12

炮塔安装  
Attaching turret

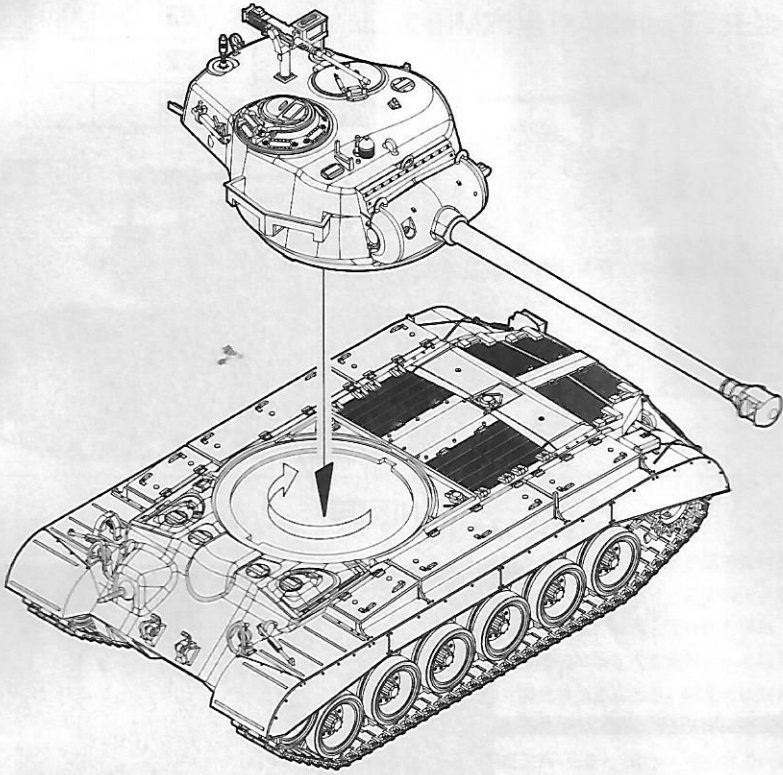

13

底座  
Stand

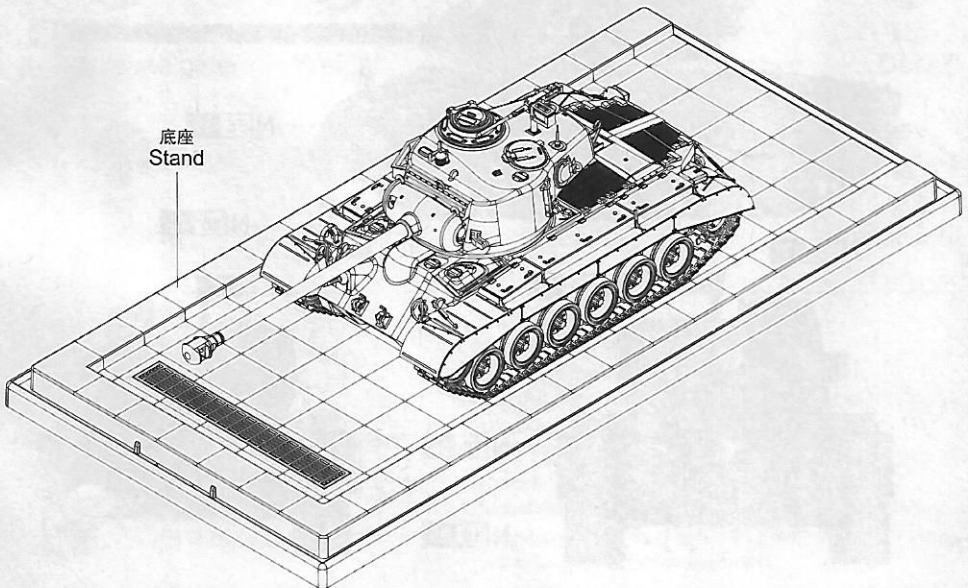

涂装同标贴指示  
Painting & Marking guide

PAINT REFERENCE COLOUR

Color	Mr.Hobby	Vallejo	Model Master	Tamiya	Humbrol
Steel 黑铁色	N 18 28	864	1402	-	-
Olive Drab(2) 橄榄(2)	N 78 38	-	-	-	-
Tire Black 胎黑色	N 77 137	-	-	-	-

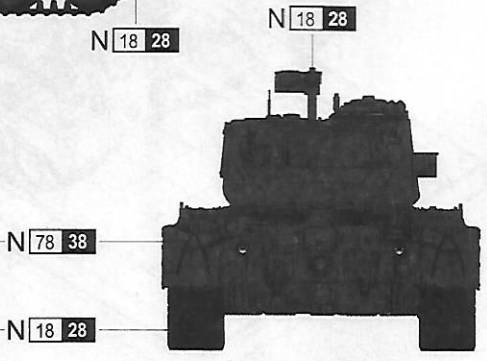
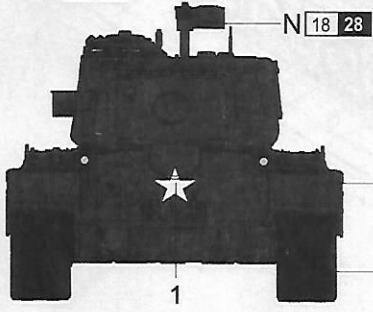
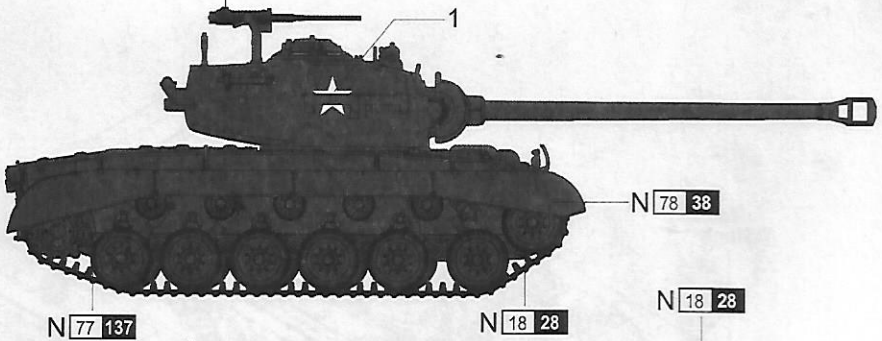
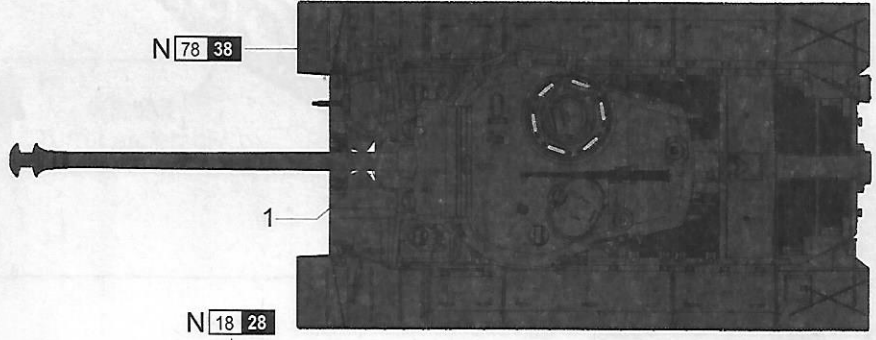
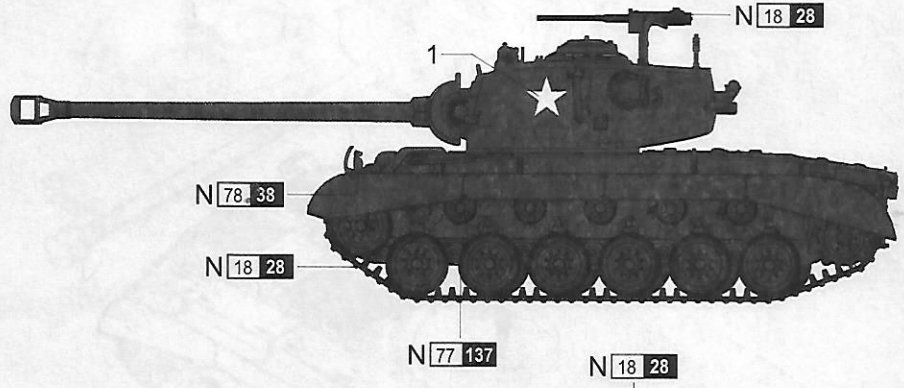

Hammy

H AQUEOUS HOBBY COLOR

Mr. COLOR