

German Half-Track

Rocket Launcher

HANOMAG

1/72

Sd. Kfz. 251/1

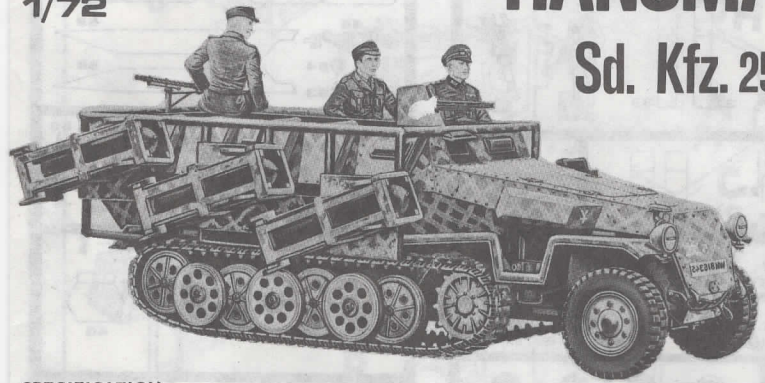

SPECIFICATION

KIT 8022

GENERAL:

DESIGNATION; MITTLERER GEPANZERTER MANNSCHAFTKRAFTWAGEN. DESIGNATION FROM 1942: MITTLERER SCHUETZENPANZERWAGEN. ORDNANCE No. SdKfz 251. MANUFACTURER'S TYPE: HANOMAG HL kl 6p.
CREW: 12—COMMANDER, DRIVE, 10 MEN INFANTRY SQUAD, IN BASIC SdKfz 251/1.

BATTLE WEIGHT: 8.9 LONG TONS.

DRY WEIGHT: 7.4 TONS.

DIMENSIONS

LENGTH OVERALL: 19 ft. (AUSF. A, B AND C). 19 ft. 7½ in. AUSF. D.

HEIGHT: 5 ft. 9 in.

WIDTH: 6 ft. 11 in.

WIDTH OVER TRACKS/OVERALL: 6 ft. 11 in.

TRACK CENTRES/WHEEL BASE: 5 ft. in./5 ft. 3 in.

TRACK WIDTH: 9¼ in.

ARMAMENT

TWO MG 34 7.92 mm.

SIX 28/32 cm. ROCKETS IN THEIR CRATES ON A FRAME DESIGNED TO CARRY THREE PROJECTILES ON EACH OF THE VEHICLE.

IN TRANSIT THE ROCKETS WERE STOWED INSIDE THE VEHICLE. NORMALLY THE LOAD CONSISTED OF FIVE 28 cm ROCKETS AND ONE 32 cm. INCENDIARY.

ENGINE

MAYBACH "HL 42 TUKRM" OR TUKRRM. PETROL. 6 CYL. IN-LINE. 4,171 c.c. 100 b.h.p. AT 2,800 r.p.m. FUEL: 35 GALLONS IN ONE TANK BETWEEN FRAME.

PERFORMANCE

MAX. ROAD SPEED: 33 m.p.h.

MAX. GRADIENT: 24°.

TRENCH: 6 ft. 6 in.

WADING DEPTH: 2 ft.

FUEL CONSUMPTION 3.5 m.p.g.



MADE IN ITALY

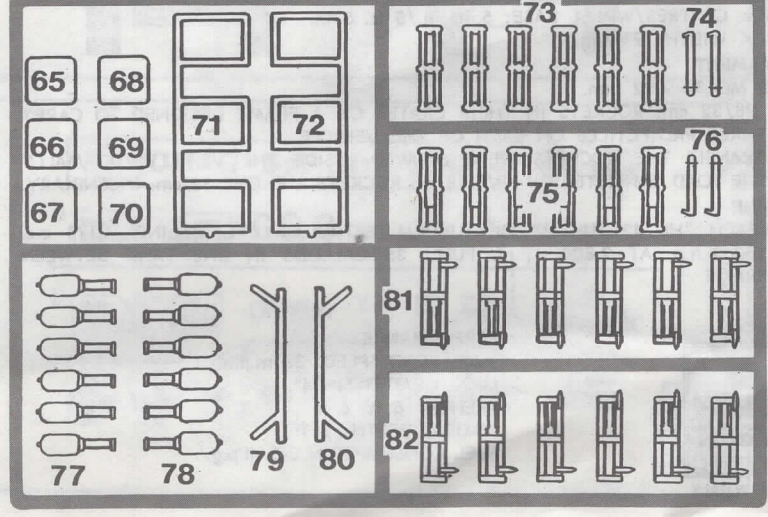
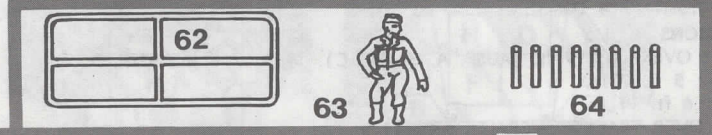
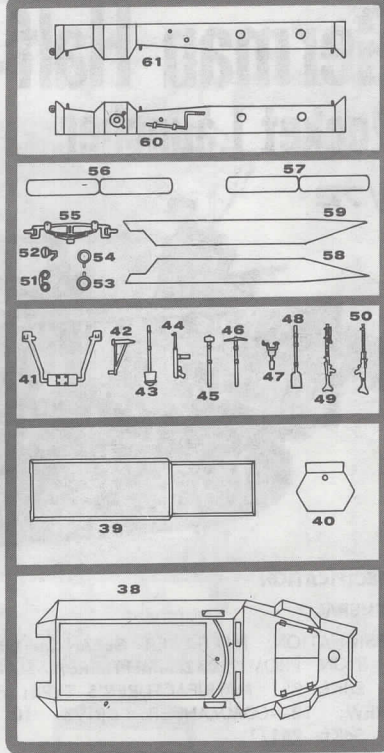
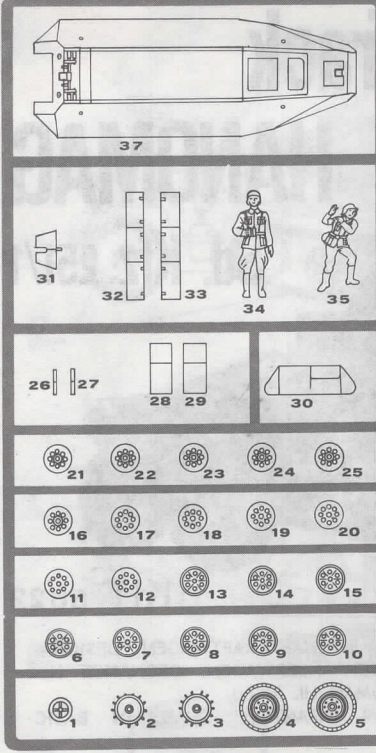

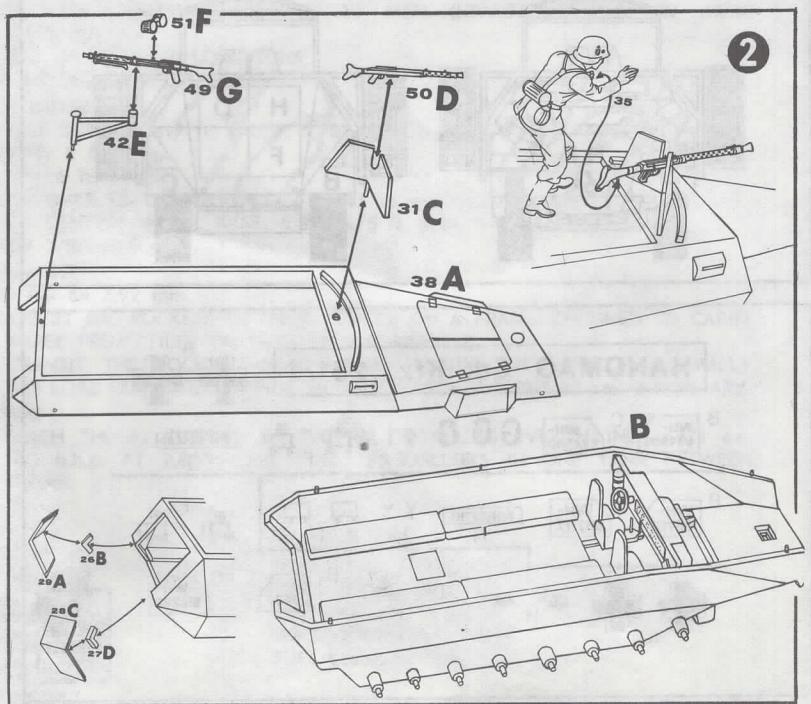
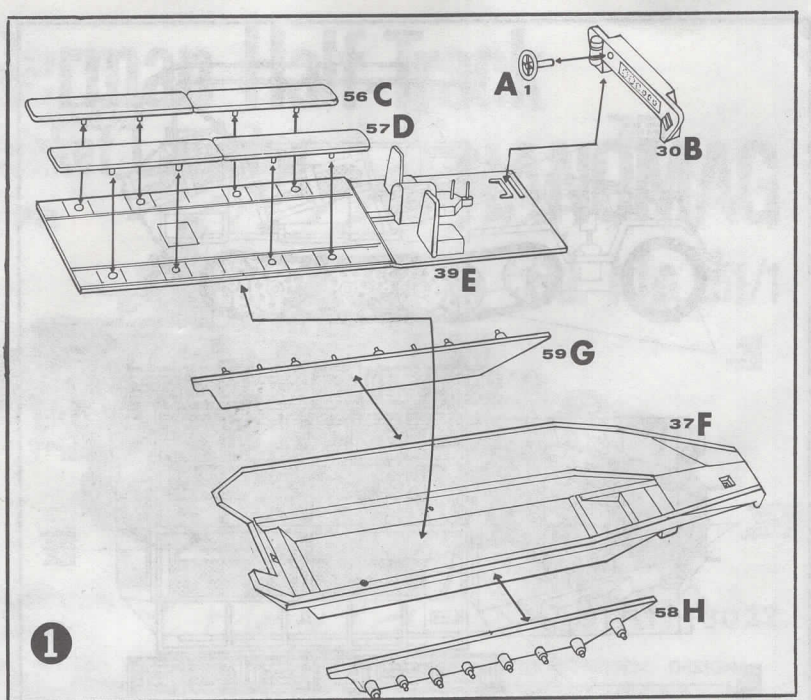

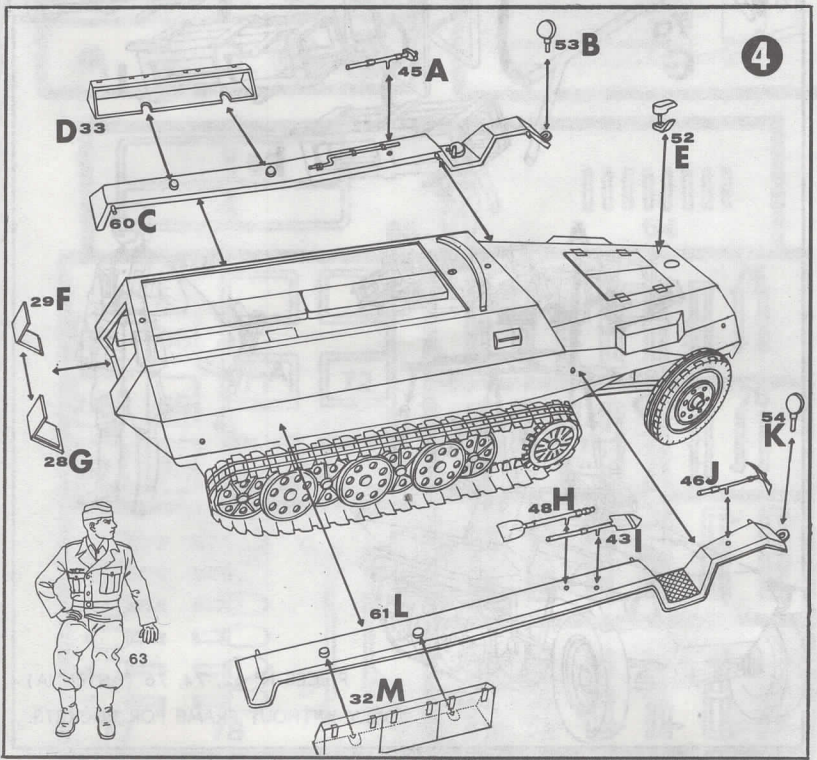
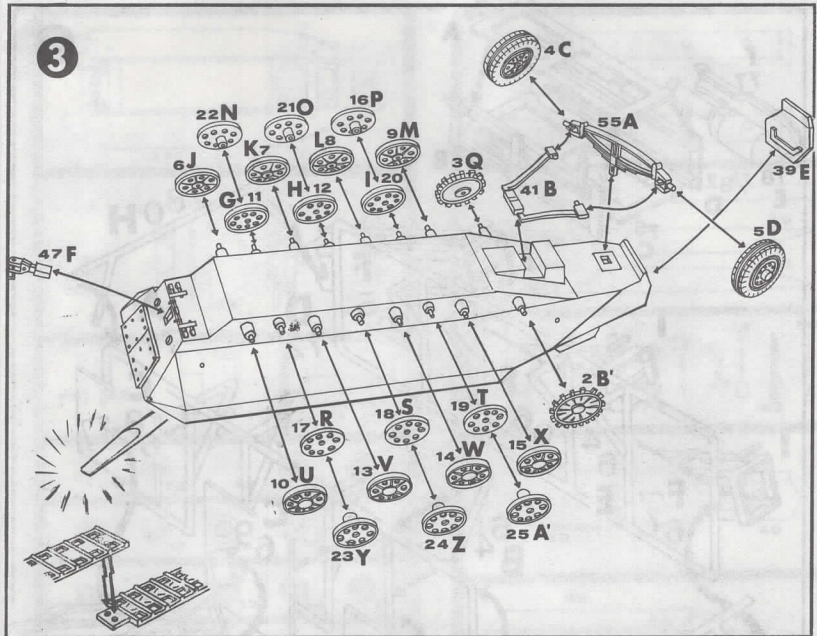

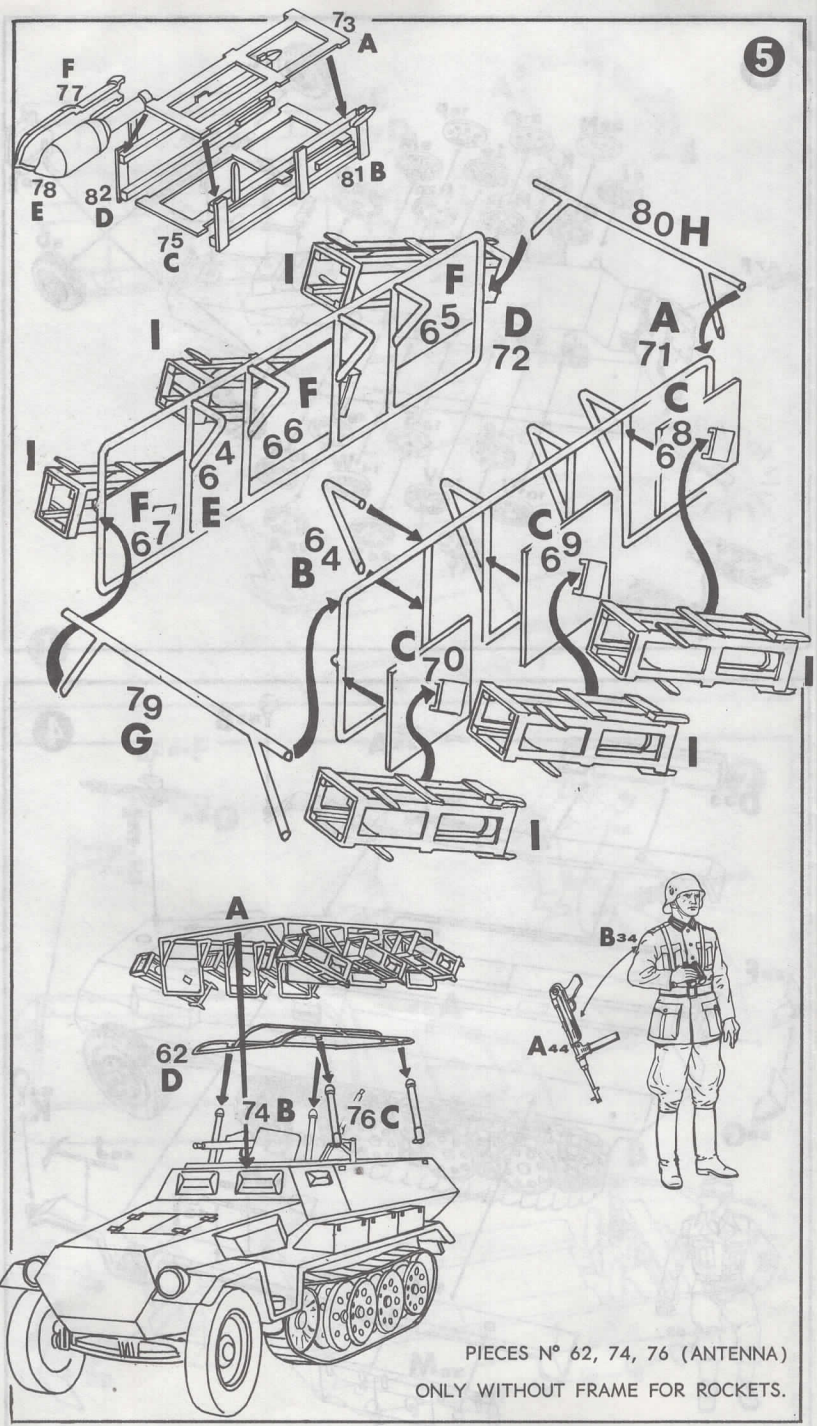



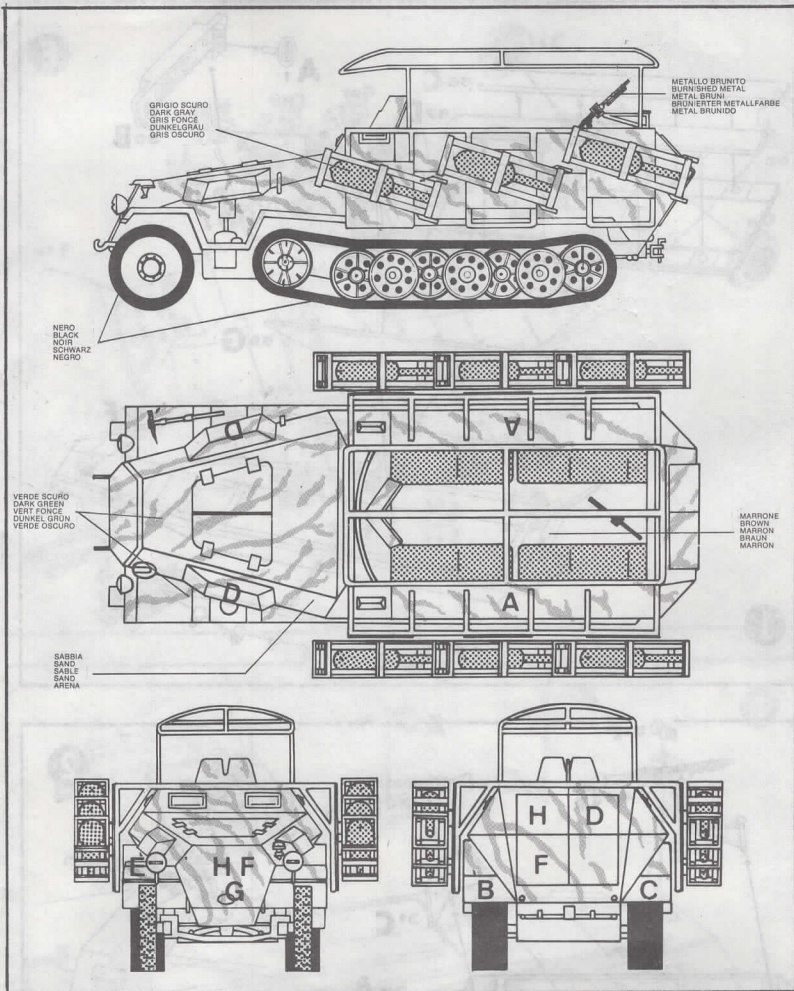

















PIECES N° 62, 74, 76 (ANTENNA)
ONLY WITHOUT FRAME FOR ROCKETS.



HANOMAG Sd. Kfz. 251/1 **A**  

B  **C**  **GGG.21**    **G**

B  **C**   **Y.Y.**    **F** 

  **H**  **B**  **C** 

MADE IN ITALY