

made in Italy

1:72 scale

No 7513

M7 Priest



TWO FIGURES
INCLUDED

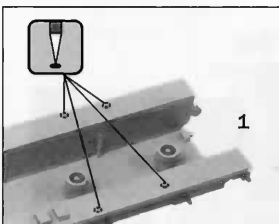
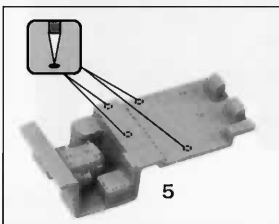

AMMUNITION CONTAINER

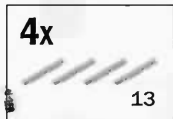

 Aprire i fori
Drill holes
Ouvrir les trous
Die Locher Ausboren
Perforar los agujeros
Open gaten

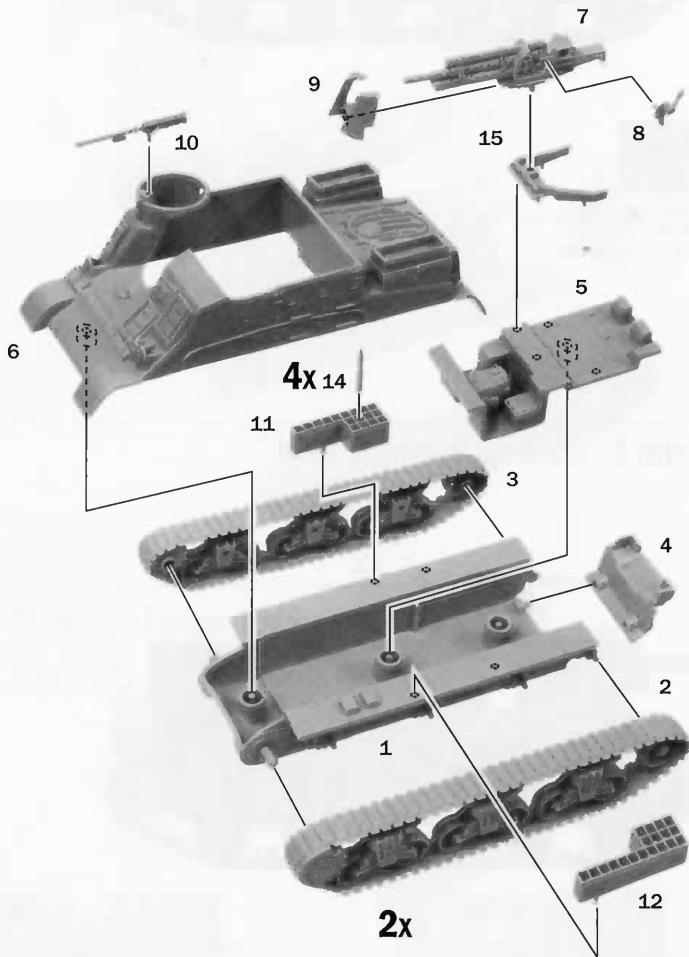

Istruzioni per l'applicazione delle decalcomanie. Ritagliare le decalcomanie occorrenti dal foglio, immergerle in un bicchiere di acqua pulita per circa 20", metterle in posizione sul modello e farle scivolare dalla carta; per una migliore aderenza comprimerle con una pezuola pulita.



Anweisungen für Abziehbilder-Anbringung: Die benötigten Abziehbilder vom Blatt abschneiden, in ein Glas reines Wasser für etwa 20" eintauchen, auf das Modell legen und dann vom Papierbogen abheben. Um eine bessere Haftung zu erzielen, die Abziehbilder mit einem reinen Tuch andrücken.

Instruction pour l'application des décalcomanies. Couper les décalcomanies choisies et les plonger environ 20" dans un peu d'eau propre. Les placer sur le modèle en les faisant glisser de leur feuille et presser avec un morceau de chiffon pour éliminer les bulles d'air.

Instrucciones Para la aplicación de las decalcomanías: cortar las requerdas, sumergirlas en un recipiente de agua limpia durante 20"; colocar las decalcomanías sobre el modelo, haciéndolas deslizar sobre el papel. Para una mejor adherencia, presionarlas con un trapito limpio.

Transfers: knip het benodigde deel uit, dempel et ca. 20" onder water, oodt het transfer tegen het model en schuif het vanaf het papier op zijn plaats. Met een schoon doekje aandrukken.

Инструкция по применению декалей: Отрезать нужную вам часть декалей от общего листа, погрузите ее на 20" минуты в чистую воду. Выбрав необходимую часть на модели, перенесите туа на поверхность, сжимая ее букалкой на основе. Для лучшего прилипания проведите декаль чистой тряпочкой.

Direction for applying the decals: cut the required decals out of the sheet; dip the into a glass of clean water for about 20"; position the decals on the kit, letting them slide from the paper. For a better adesion, press them by means of a clean rag.

Påsatning av decaler: klipp ut den decal som skall användas och doppa den i ett glas vatten under en 20". Sätt decalen på plats på modellen och låt den sakta glida av pappret. För att den skall sitta ordentligt, tryck till med en torr duk.

Version A - Free French Army, Cassino Area, Italy 1944

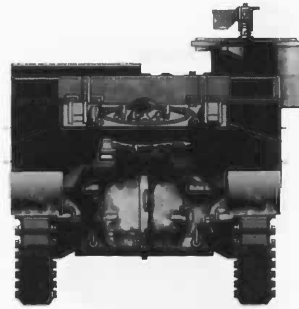
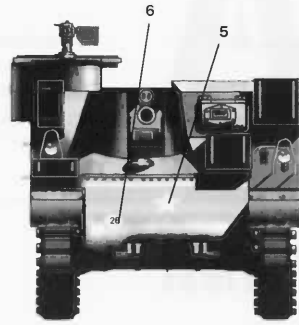
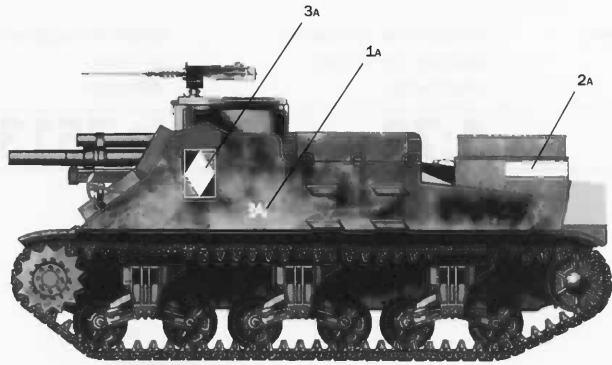

Kangaroo

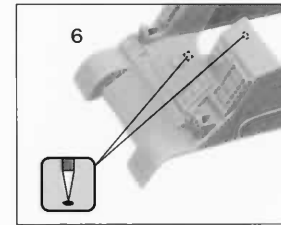
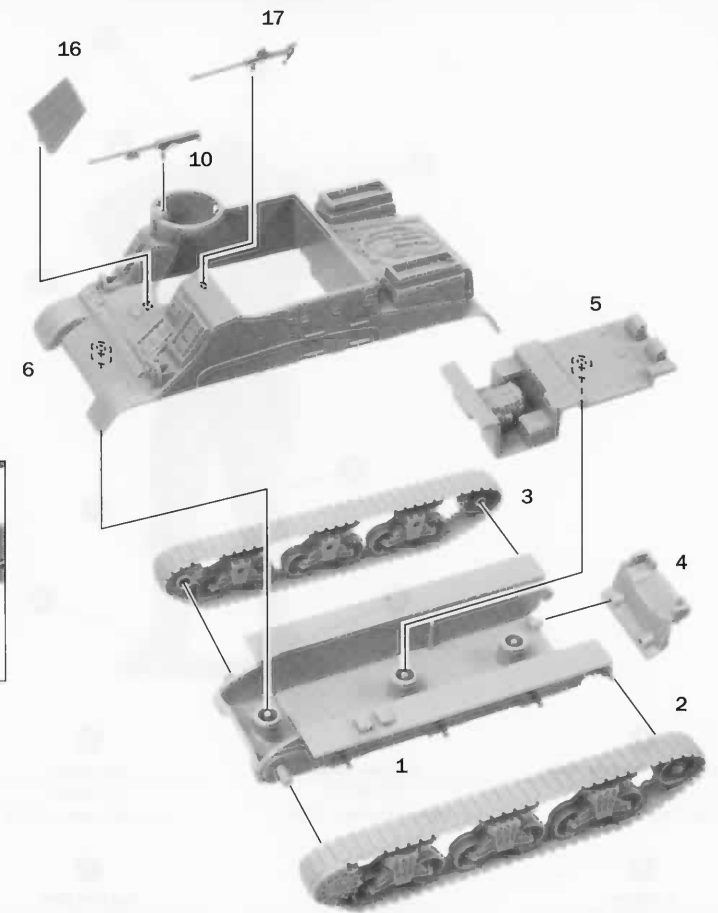



 Aprire i fori
 Drill holes
 Ouvrir les trous
 Die Locher Ausbohren
 Perforar los agujeros
 Open gaten

2x

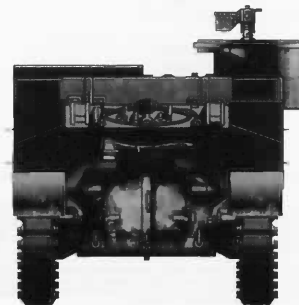
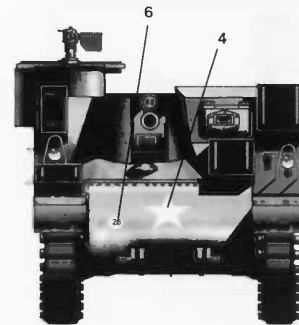

FLAT OLIVE DRAB
 F.S. 34084
 ITALERI ACRYLIC PAINT 4728AP

Version B - U.S. Army, Normandy 1944



Version C - Canadian Army, North Western Europe 1945

Version D - New Zealand Army, Italy 1945

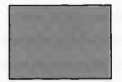

FLAT OLIVE DRAB
 F.S. 34084
 ITALERI ACRYLIC PAINT 4728AP

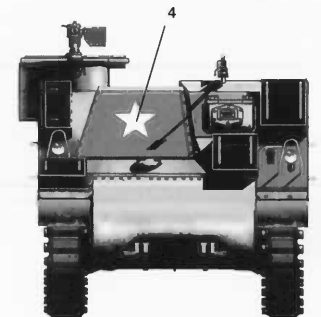

FLAT OLIVE DRAB
 F.S. 34084
 ITALERI ACRYLIC PAINT 4728AP

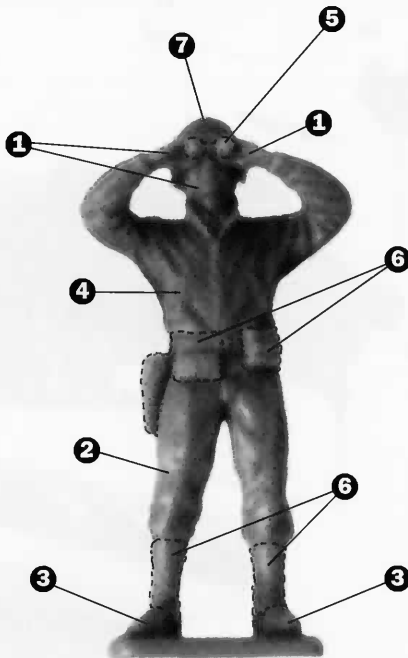

1

FLAT SKIN TONE TINT BASE - LIGHT

F.S. 31575

ITALERI ACRYLICPAINT - 4601

2

FLAT LIGHT BROWN

F.S. 30219

ITALERI ACRYLICPAINT - 4305

3

FLAT LEATHER

F.S. 30100

ITALERI ACRYLICPAINT - 4674

4

FLAT MEDIUM GREEN II

F.S. 34082

ITALERI ACRYLICPAINT - 4734

5

FLAT BLACK

F.S. 37038

ITALERI ACRYLICPAINT - 4768

6

FLAT FIELD DRAB

F.S. 30118

ITALERI ACRYLICPAINT - 4708

7

FLAT OLIVE DRAB

F.S. 34034

ITALERI ACRYLICPAINT - 4728

I numeri si riferiscono all'assortimento colori Italeri Acrylic Paint

The indicated colour number refer to the Italeri Acrylic Paint

Les références indiquées concernent les peintures Italeri Acrylic Paint

Die angegebenen farbnummern beziehen sich auf die Italeri Acrylic Paint

Los números se refieren a los colores surtido Italeri Acrylic Paint

De nummers verwijzen naar het assortiment kleuren Italeri Acrylic Paint



KIT No 7513 Scale 1:72 M7 Priest / Kangaroo

NAME NOME NAME NOM NOMBRE NAAM	ADDRESS INDIRIZZO ADRESSE ADRESSE DIRECCION ADRES
-----------------------------------------------	------------------------------------------------------------------

TOWN CITTA	POSTAL CODE C.A.P.	COUNTRY NAZIONE	DATE OF BIRTH DATA DI NASCITA
STADT VILLE CIUDAD GEMEENTE	POSTALEITZAHN CODE POSTALE CODIGO POSTAL POSTCODE	LAND PAYS PAIS LAND	GEBURTSDATUM DATE DE NAISSANCE NACIDO/A EL GEBORRTEDATUM

E-MAIL

DEFECTIVE PARTS PARTI DIFETTOSI DEFEKTE TEILE PIECES DEFECTUEUSES PIEZAS DEFECTUOSAS DEFECTE ONDERDELEN	<input type="checkbox"/> Retail Store <input type="checkbox"/> Negozio <input type="checkbox"/> Einzelhandel <input type="checkbox"/> Detailant <input type="checkbox"/> Detailista <input type="checkbox"/> Detailhandel	<input type="checkbox"/> Hyper Market <input type="checkbox"/> Grande Magazzino <input type="checkbox"/> Andere <input type="checkbox"/> Grande Surface <input type="checkbox"/> Gran Almacen <input type="checkbox"/> Hypermarket
------------------------------------------------------------------------------------------------------------------------	------------------------------------------------------------------------------------------------------------------------------------------------------------------------------------------------------------------------------------------	---------------------------------------------------------------------------------------------------------------------------------------------------------------------------------------------------------------------------------------------------

ITALERI S.p.A.
Via Pradazzo, 6/B
40012 - Calderara di Reno (BO) ITALY
fax: 0039 51 726 459
e-mail: italeri@italeri.com
www.italeri.com