

# Aircraft Colour Guide

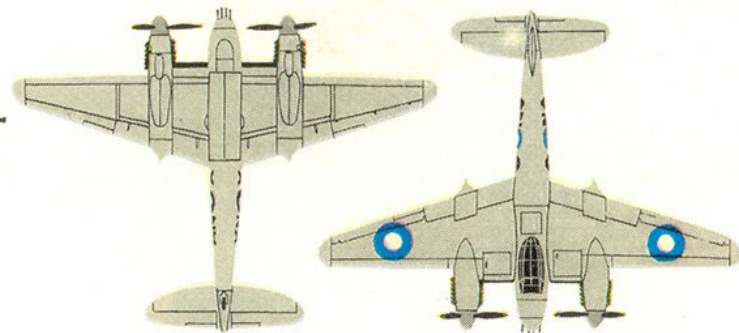

Mk.6 FIGHTER No.1 Squadron  
Royal Australian Air Force

# De Havilland Mosquito Mk4 or Mk6

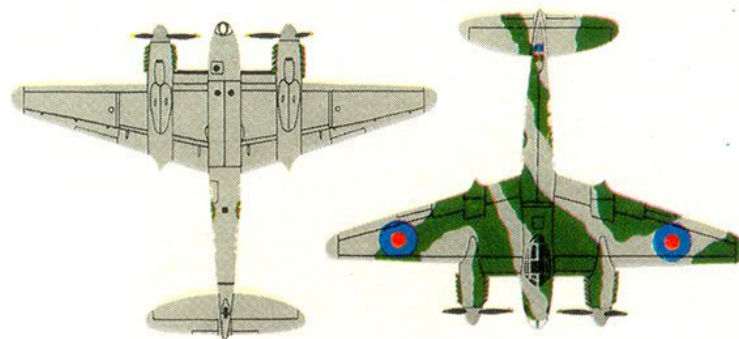

Made in Great Britain by Rovex Industries Ltd.

# FROG<sup>®</sup> MOSQUITO-M<sup>K</sup> 4 OR 6

How to put your model together.  
 Mode d'assemblage de votre modèle.  
 Anweisungen für den Zusammenbau des Modells.  
 Methode voor het in elkaar zetten van Uw model.  
 Så här sätter Du ihop modellen.  
 Per montare il vostro modello.

Symbols used in assembly diagrams / Symboles employés sur les diagrammes d'assemblage / In den Zusammenstellungsskizzen verwendete Zeichen.  
 Tekens die in de monteringsdiagrammen gebruikt worden / Teckenförklaring till sammanfogningsdiagram / Simboli usati nello schema di montaggio.

**U** Cement parts together.  
 Coller les pièces ensemble.  
 Teile zusammenkleben.  
 Cementeer de delen samen.  
 Lijma liop delanna.  
 Cementare le parti l'una con l'altra.

**X** Do not cement together.  
 Ne pas coller ensemble.  
 Nicht zusammenkleben.  
 Cementeer niet samen.  
 Lijma liie hoop delanna.  
 Non cementare le parti.

**?** Shape with hot knife.  
 Former au caustic chaud.  
 Mit einem heißen Messer formen.  
 Vorm met een heet mes.  
 Forma med varmt kniv.  
 Modellere con la lama di un coltello riscaldata.

**?** Choice of parts provided.  
 Choix de pièces fournies.  
 Mitgelieferte Auswahl an Teilen.  
 Keuze van beschikbare onderdelen.  
 Dessa delar medföljer för valfri användning.  
 Particolari a scelta.

**U** Cut with a sharp knife.  
 Couper avec un couteau tranchant.  
 Mit einem scharfen Messer schneiden.  
 Snij met een scharp mes.  
 Skär med en skarp kniv.  
 Tagliare con un coltello ben affilato.

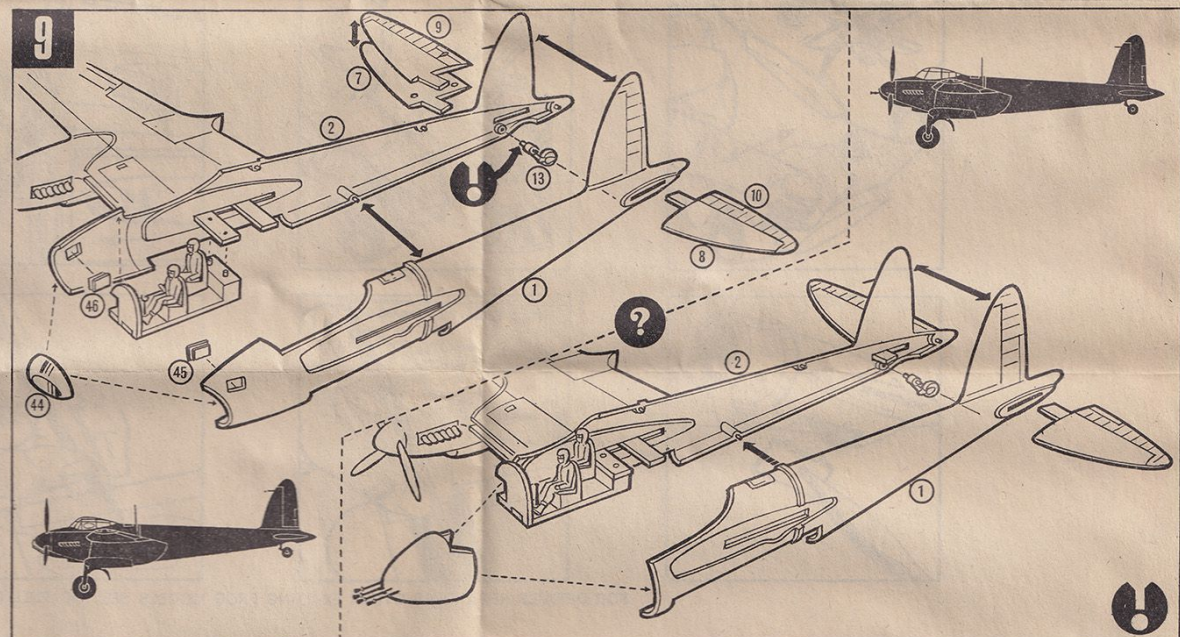
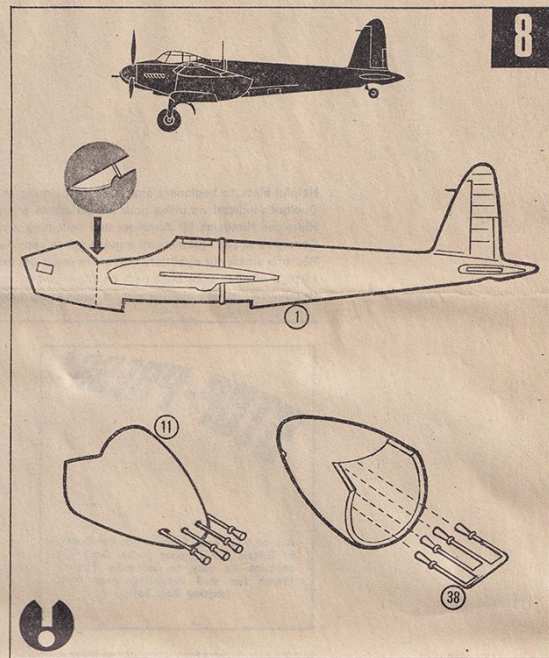
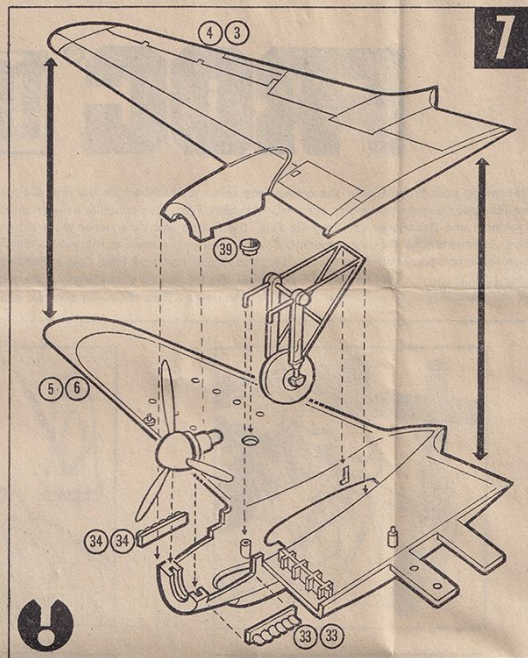
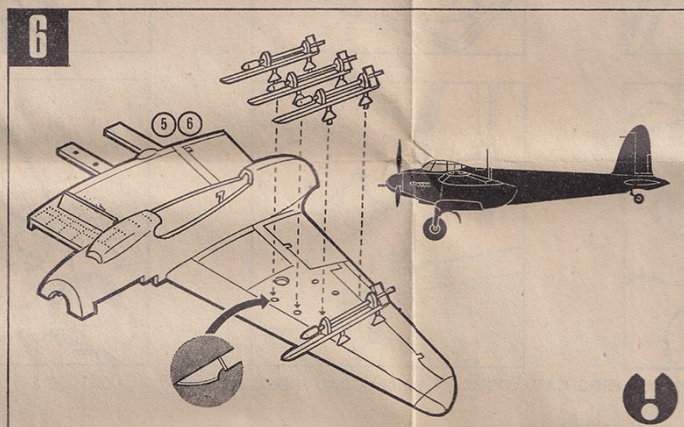
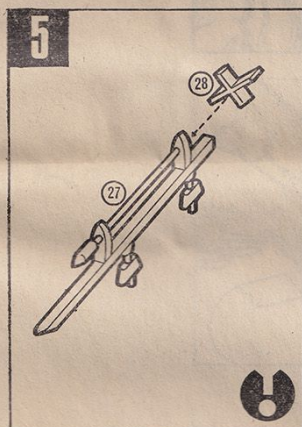
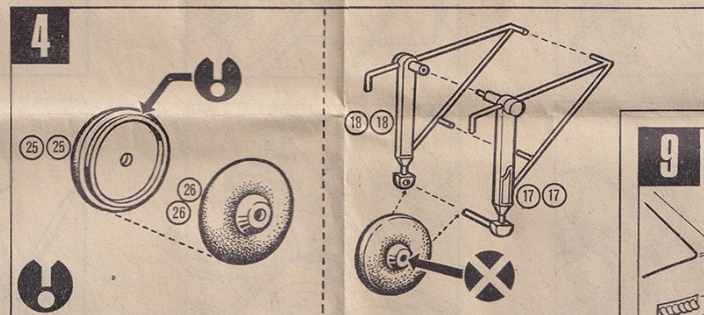
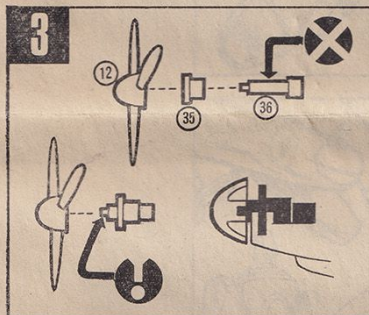
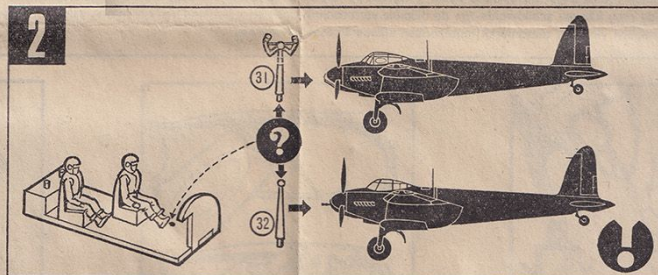
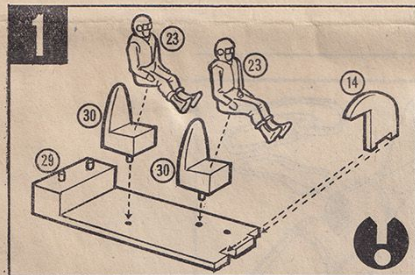

# FROG<sup>®</sup> top model tips

Helpful hints to beginners and guide to painting and decorating your Frog Model. The colours and reference numbers on the Frog Colour Painting Guide Profile are the official descriptions of paint for the country of origin of the aircraft.  
 Quelques indications utiles pour les débutants et instructions pour peindre et décorer votre modèle réduit Frog. Les couleurs et les numéros de référence indiqués sur le Guide de couleurs Frog sont les descriptions officielles de la peinture pour le pays d'origine de l'avion.  
 Hilfreiche Hinweise für Anfänger und Anleitung zum Lackieren und Dekorieren des Frog-Modells. Die Farben und Verweisnummern auf der Frog-Anstrichschablone stellen die offiziellen Bezeichnungen des Anstrichs für das Ursprungsland des Flugzeugs dar.  
 Consigli utili per i principianti e guida, per la verniciatura e ornamentazione del vostro modello Frog. I colori ed i numeri di riferimento indicati nella guida per verniciatura Frog rappresentano le descrizioni ufficiali dei paesi di origine degli apparecchi.  
 Råd och vinkar för nybörjare och anvisningar om hur man målar och pryder sin Frog Model. Färgerna och siffrorna på Frog Colour Painting Guide Profile anger de officiella beskrivningarna på färger för de länder där flygplanen har sitt ursprung.  
 Nuttige wenken voor beginners en aanwijzingen voor het schilderen en afwerken van je Frog model. De kleuren en verwijzingsnummers op de Frog kleuren schildergids zijn de officiële verbodsbijdringen voor het land van oorsprong van het vliegtuig.  
 Hyödyllisiä vihjeitä aloittelijoille, ja opas Frog Model! liisi maalaukseen ja koristeluun. Värit ja ohjenumerot Frog värimallin sivussa, ovat maalien viralliset tuntemerkit lentokoneen alkuperäisessä kotimaassa.

**STOP-PRESS**

Ask at your Frog Stockist for the Battle of Britain Air Combat packs. Each Kit contains an easy to assemble Picture Frame for wall mounting your most exciting Box Tops.

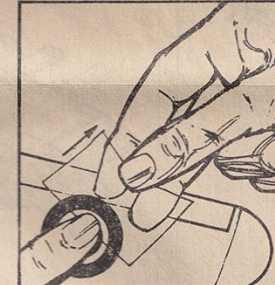
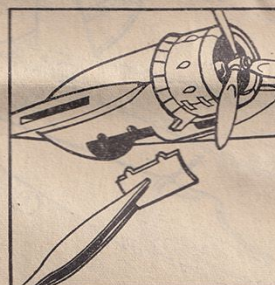
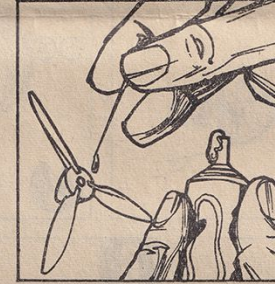
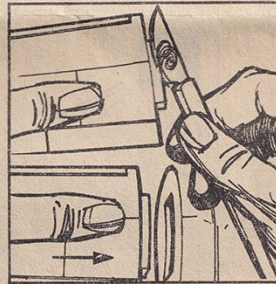
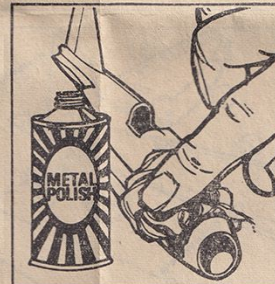
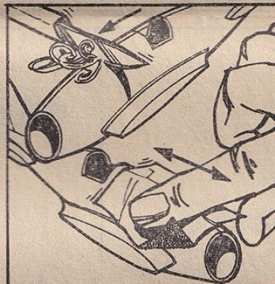
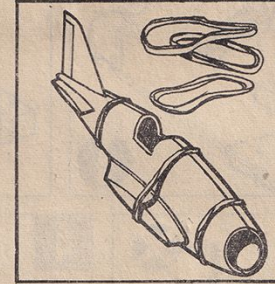
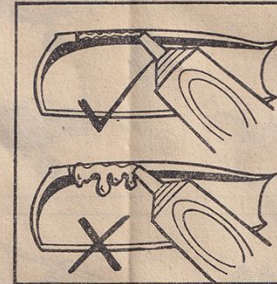
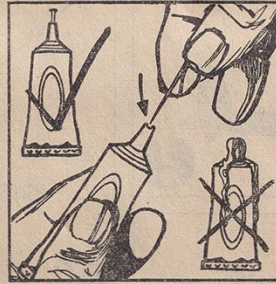
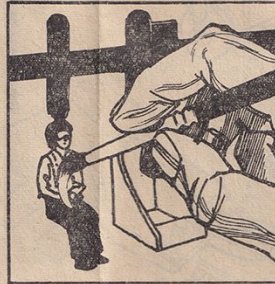

FOR DETAILS REGARDING OTHER EXCITING FROG MODELS SEE THE FULL COLOUR FROG CATALOGUE AT YOUR LOCAL FROG STOCKIST