

Endeavour Class Conversion

JTM-006

For the AMT/Ertl 650 scale USS Enterprise model Kit #6676 or similar.

Preparation:

- Clean model with a strong cleaning agent in order to remove any mold release from your model. Cleaners like Ajax or Comet are recommended.
- Mold seams should be sanded and imperfections filled with modeling putty.
- Test fit all parts before gluing them together.
- Cyanoacrylate glue (super glue) should be used in attaching parts. Regular model glue will not work.
- If warping occurs, use a hair dryer to soften/relax the area. Adjust the part, cool it with cool water and when cool, the part should retain it's shape.
- Prime model before final painting with a thin coat of primer and lightly sand with 400 grit sandpaper.
- After the model is painted, follow the instructions for decal placement.

Part Mastered by: Steve Lord
Casting by: Monz

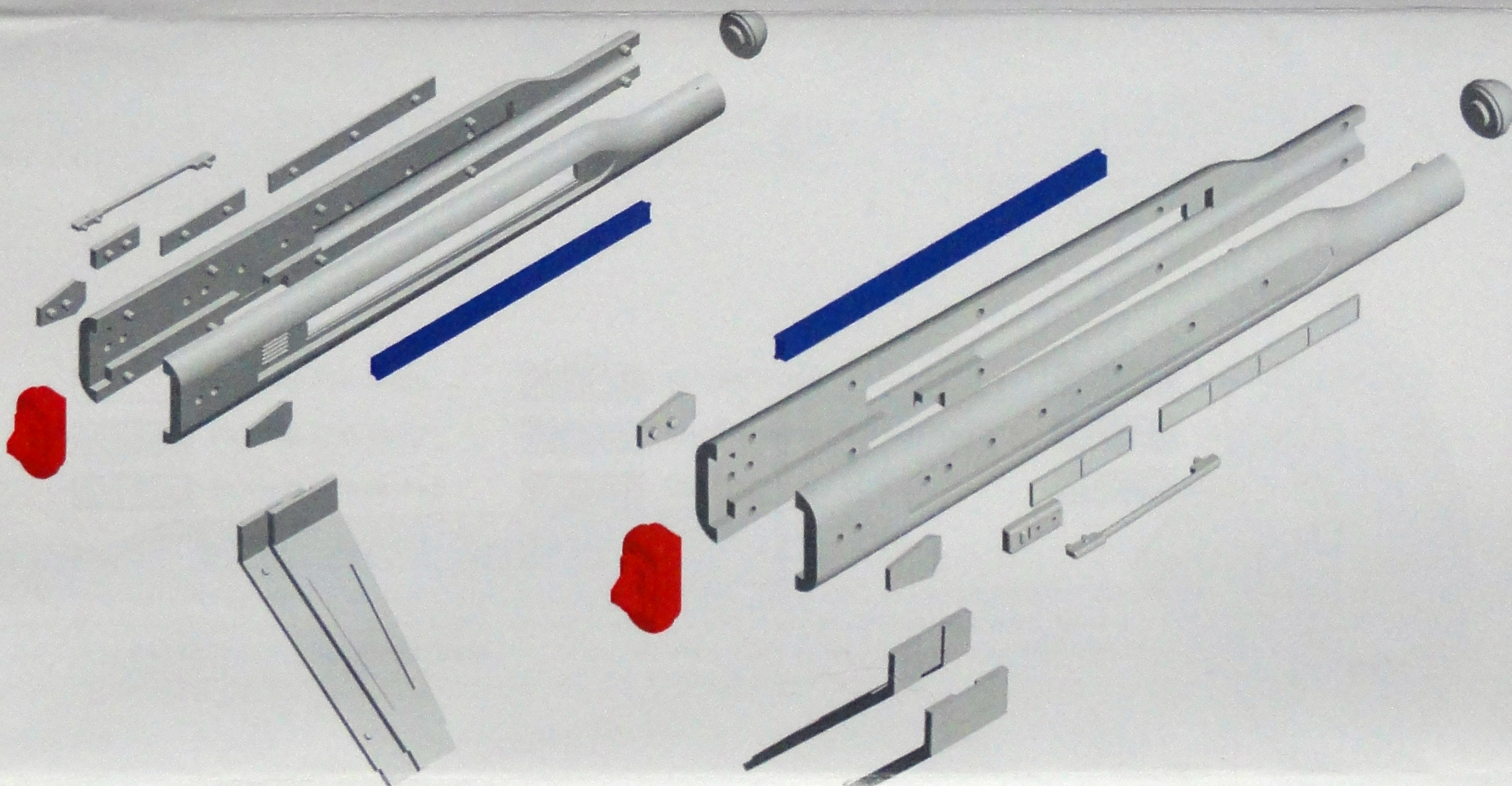

Starboard Nacelle & Pylon Assembly

Port Nacelle & Pylon Assembly







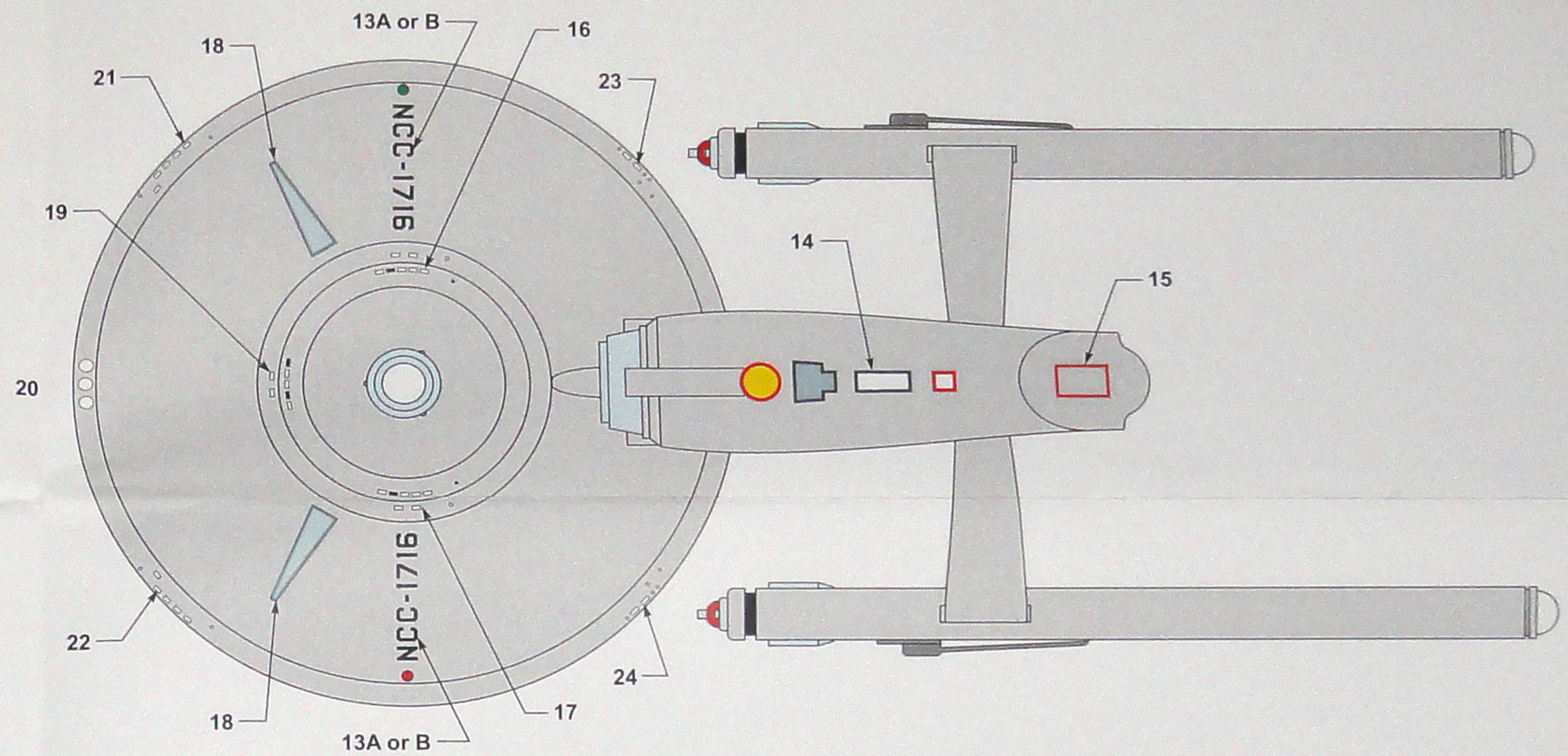
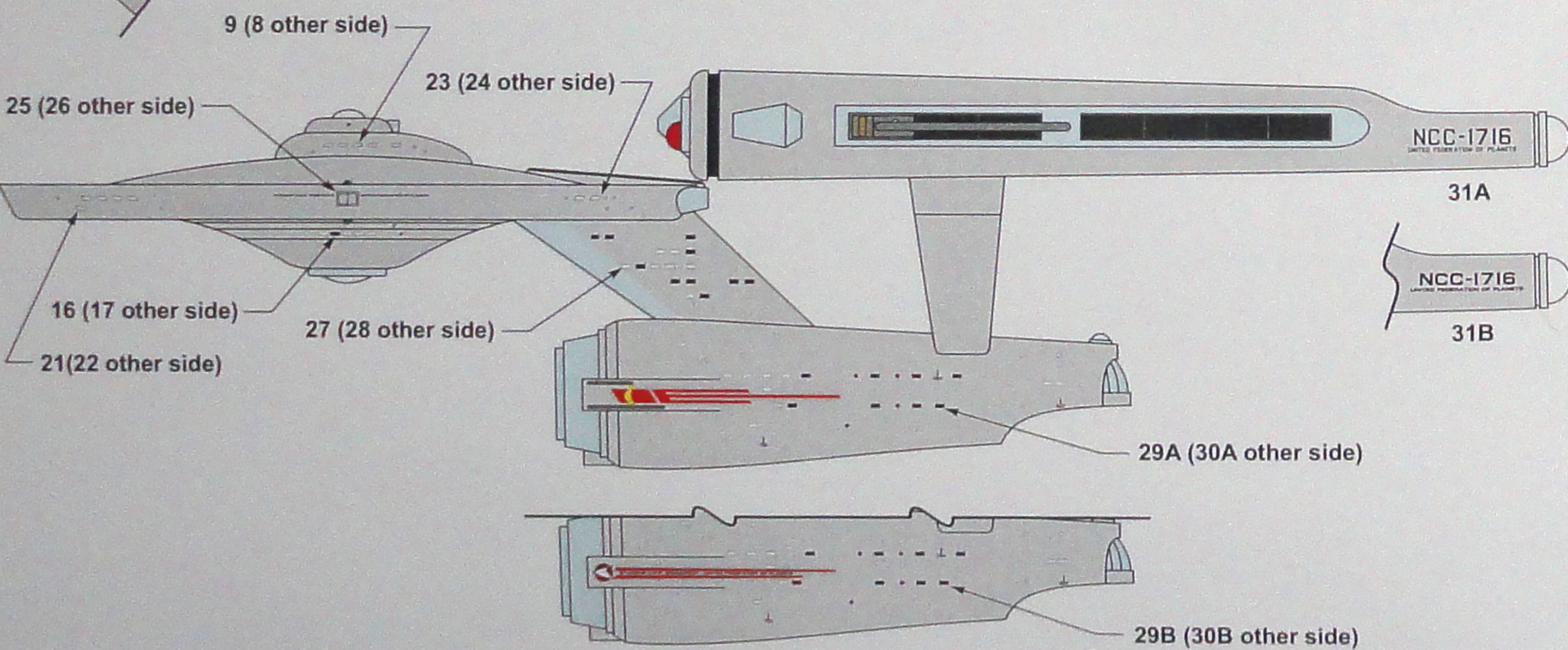
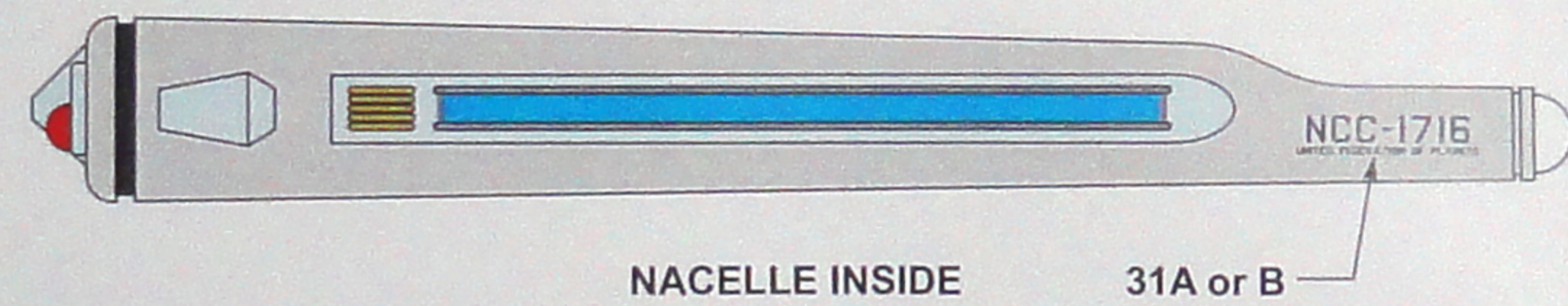
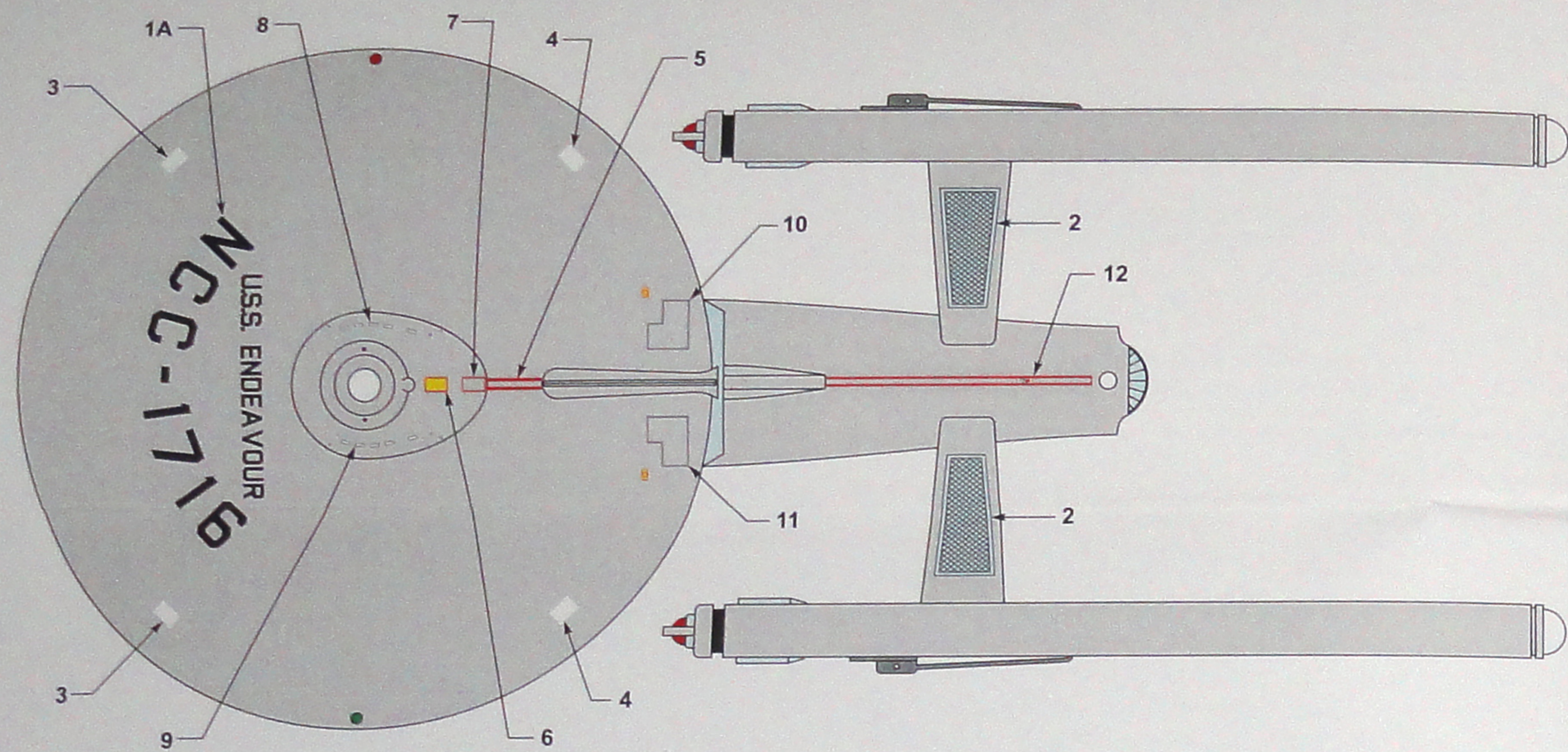

Note:

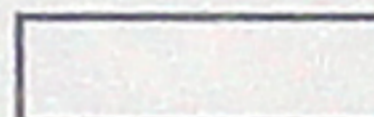
We suggest using 1/16" Brass Square Tubing on each side of the channel in the pylon to help support the weight of the nacelle. There should be enough room left for you to run wires for lighting.

Replace part #6 with the new Hull End Cap

Painting and Decaling:



 Fs 36495 (Flat White)	 Fs 13630 (Gold)	 Fs 17038 (Gloss Black)
 Fs 36495 (Light Grey)	 Sky Blue (with a clear blue wash)	 Steel
 Fs 16473 (Aircraft Grey)	 Clear Red	 Clear Green

Decals:

Decals are best applied to a glossy surface. Apply glossy paint or spray a clear gloss coating on your model before applying decals. Carefully cut out the decal from the sheet and using tweezers, dip the decal into plain water for about 5 seconds or until the backing paper changes color. (Note: Smaller decals may take less time). Lay the decal on your work surface for 30 seconds, then slide the decal of the backing paper into position on your model. Gently blot the excess water. Allow to dry. Apply a second coat of clear finish over the model to seal the decals.

A decal set may be used to help the decal conform to irregular surfaces and hides the decal film. This makes the artwork appear to be painted on the model, rather than applied by decal.

Another method used to hide/prevent decal silvering is to create an equal mixture of water and white glue (Elmer's). Using a brush, apply the mixture to the surface. While still wet, apply the decal. The glue will help the decal adhere to the surface and will dry clear.

