

P-61A-5-NO. 422nd. NFS, USAAF, Scorton, England, mid-1944.

C

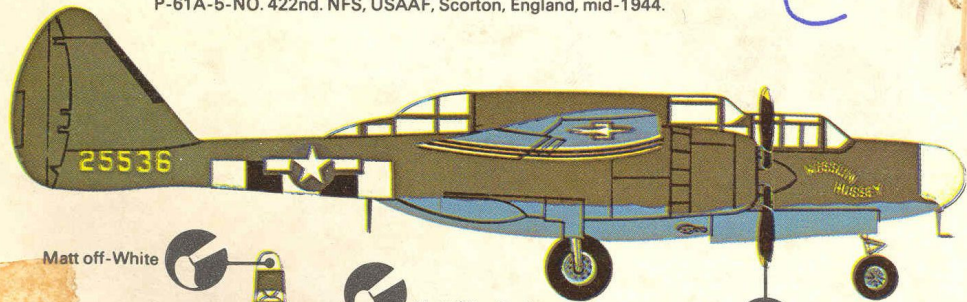

Matt off-White

Matt Olive Drab

Propeller Blades Semi-Gloss Black with 4in. Orange-Yellow tips

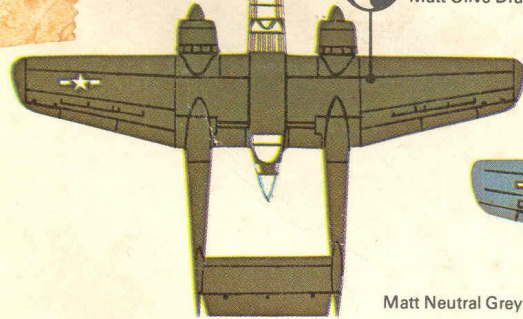

Matt Neutral Grey

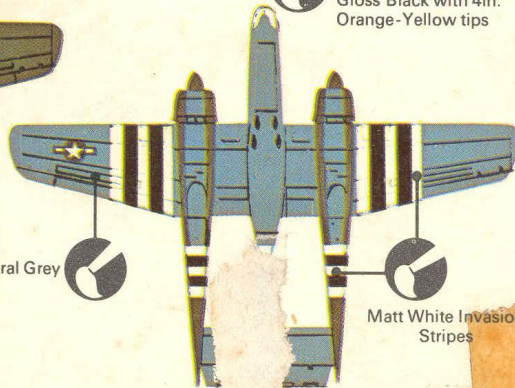

Matt White Invasion Stripes

P-61A-10-NO. 422nd. NFS, USAAF, Scorton, England, late 1944. Aircraft flown by Lt. R. C. Bolinder.

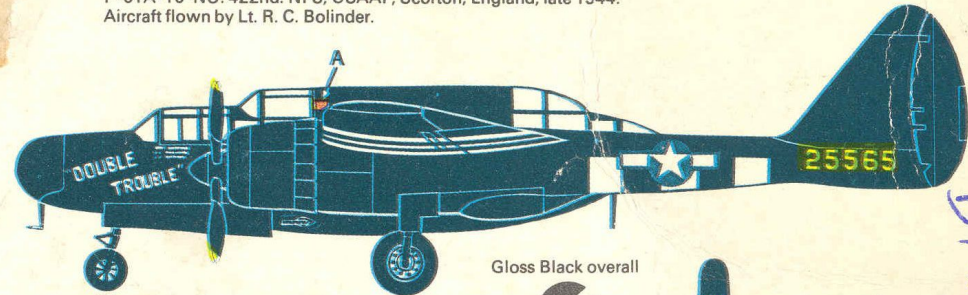

Gloss Black overall

B12

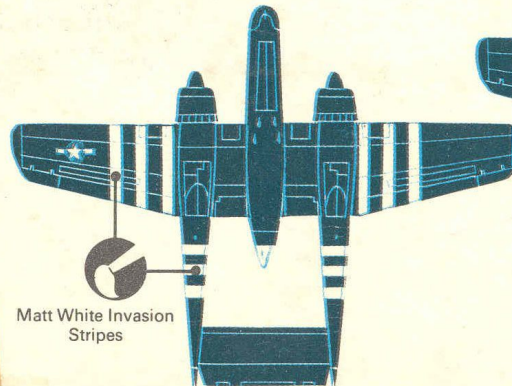

Matt White Invasion Stripes

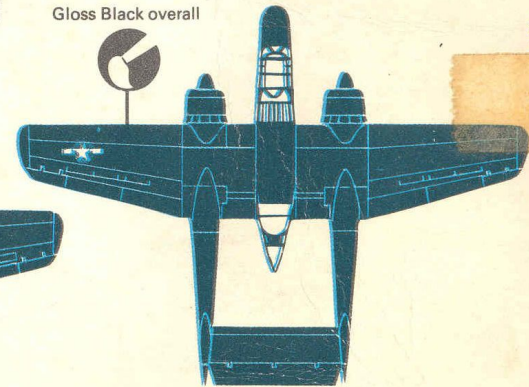

Requires Cement and Paint

Made in Great Britain by

ROVEX Limited

FROG® F.170 NORTHROP BLACK WIDOW

ROVEX Limited

How to put your Frog model together/Méthode d'assemblage de votre modèle Frog/Wie stellt man Ihr Frogmodell zusammen/Come montare il modello Frog/Hoe zet ik mijn Frogmodel in elkaar/Hur man sätter ihop Frog-modellen/Kootkaa Frog mallinne näin.

- 

Cement parts together.
Coller les pièces ensemble.
Teile zusammenkleben.
Cementare le delen samen.
Limma ihop delarna.
Cementare le parti l'una con l'altra.
Osat liimataan yhteen.
- 

Do not cement together.
Ne pas coller ensemble.
Nicht zusammenkleben.
Cementeer niet samen.
Limma inte ihop delarna.
Non cementare le parti.
Osia ei liimata yhteen.
- 

Shape with hot knife.
Former au canif chaud.
Mit einem heißen Messer formen.
Vorm met een heet mas.
Forma med varm kniv.
Modellare con la lama di un coltello, riscaldato.
Muovattaa kuumalla veitsellä.
- 

Choice of parts provided.
Choix de pièces fournies.
Mittelieferte Auswahl an Teilen.
Keuze van beschikbare onderdelen.
Dessa delar medföljer för valfri användning.
Particolari a scelta.
Osien kay to valinnanvaraisista.
- 

Paint parts before using.
Peindre les pièces avant l'emploi.
Die Teile sollen vor Benutzung bemalt werden.
De onderdelen voor het gebruik schilderen.
Måla delarna före användningen.
Verniciare le parti prima di montarle.
Maalata osat ennen kokoamista.
- 

Cut with sharp knife.
Couper avec un couteau tranchant.
Mit einem scharfen messe schneiden.
Snijd met een scherp mes.
Skär med en skarp kniv.
Tagliare con un coltello affilato.
Leikataa terävällä vietsellä.
- 

Insert small weight.
Introduire le petit contrepoids.
Das kleine Gewicht soll eingesteckt werden.
Een klein gewichtje invoegen.
Stick in en liten tyngd.
Introdurre il piccolo peso.
Lisä ikää pieni paino.

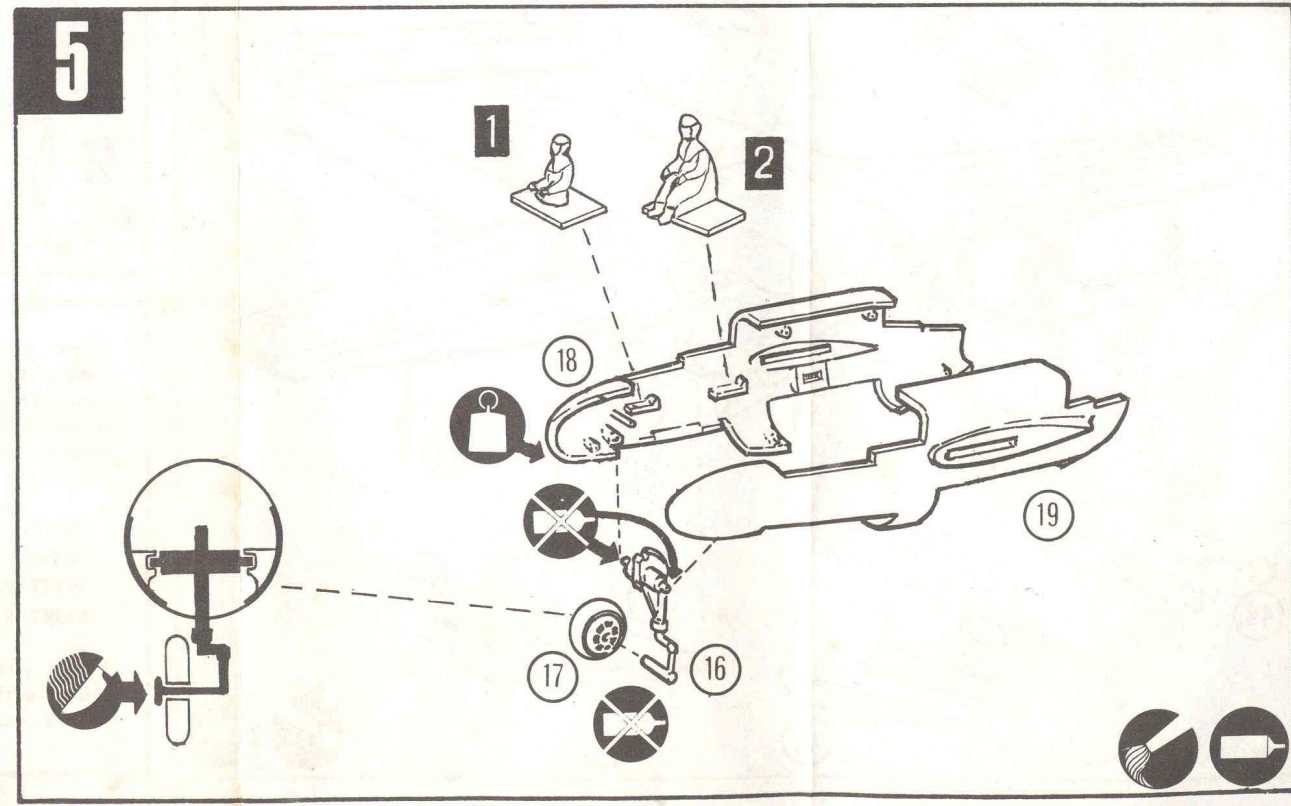
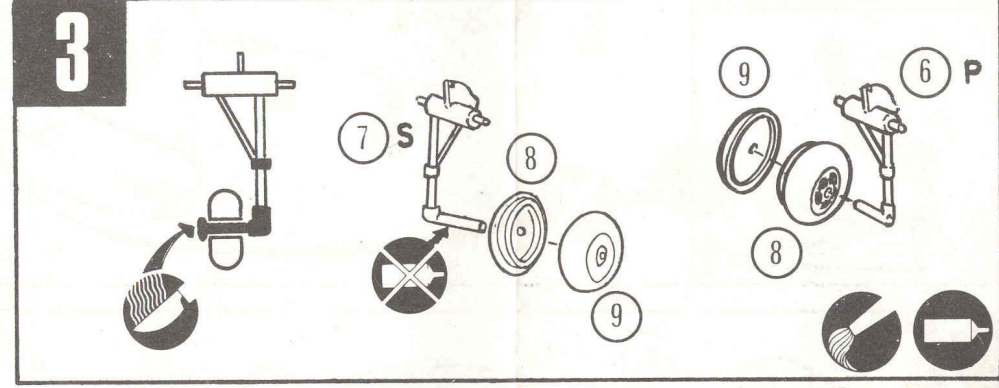
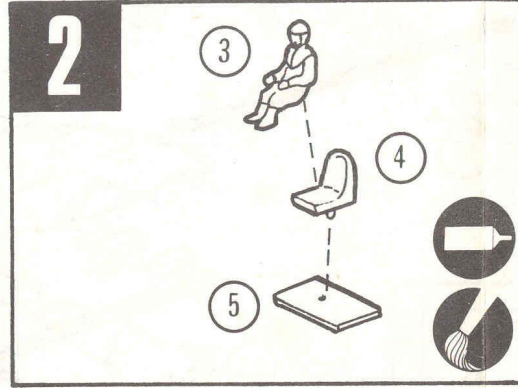
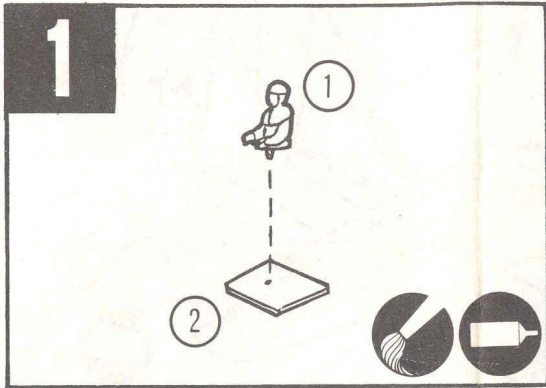

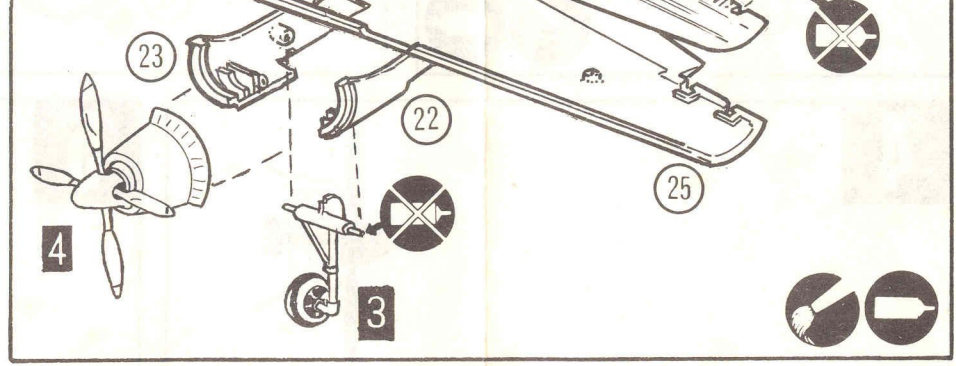
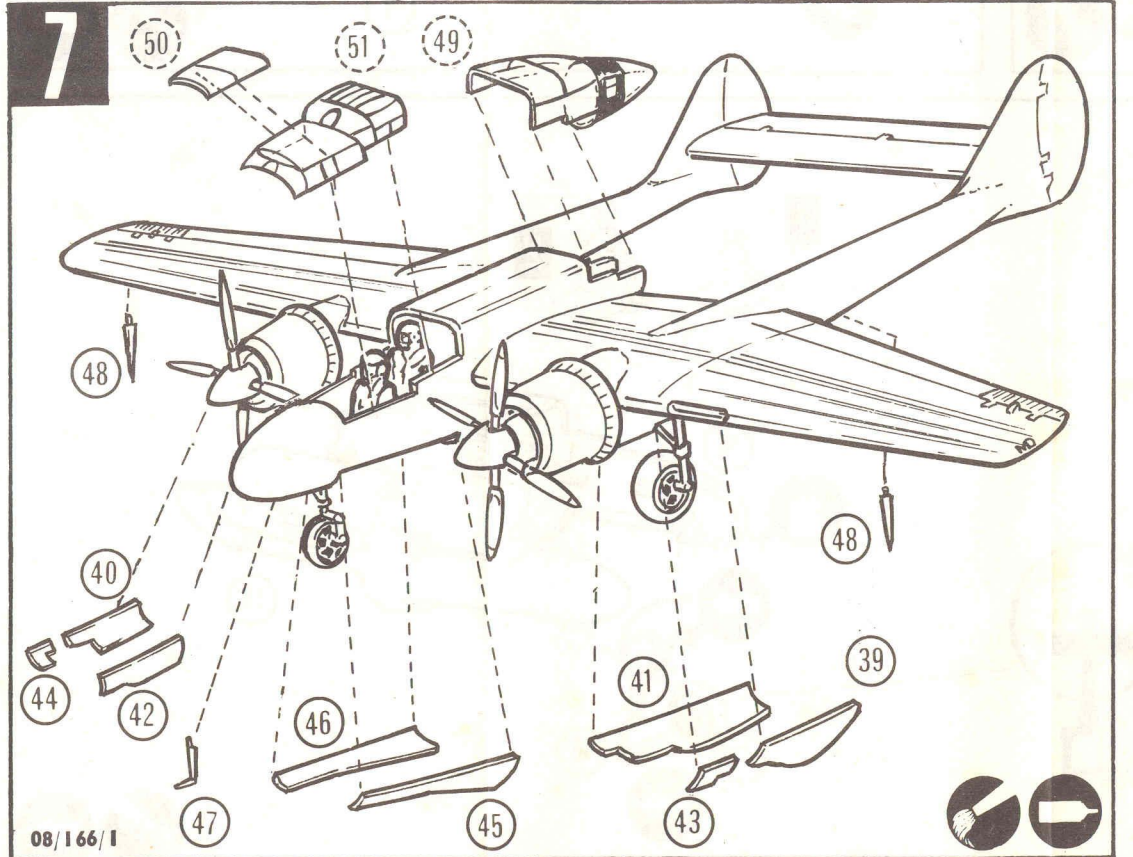
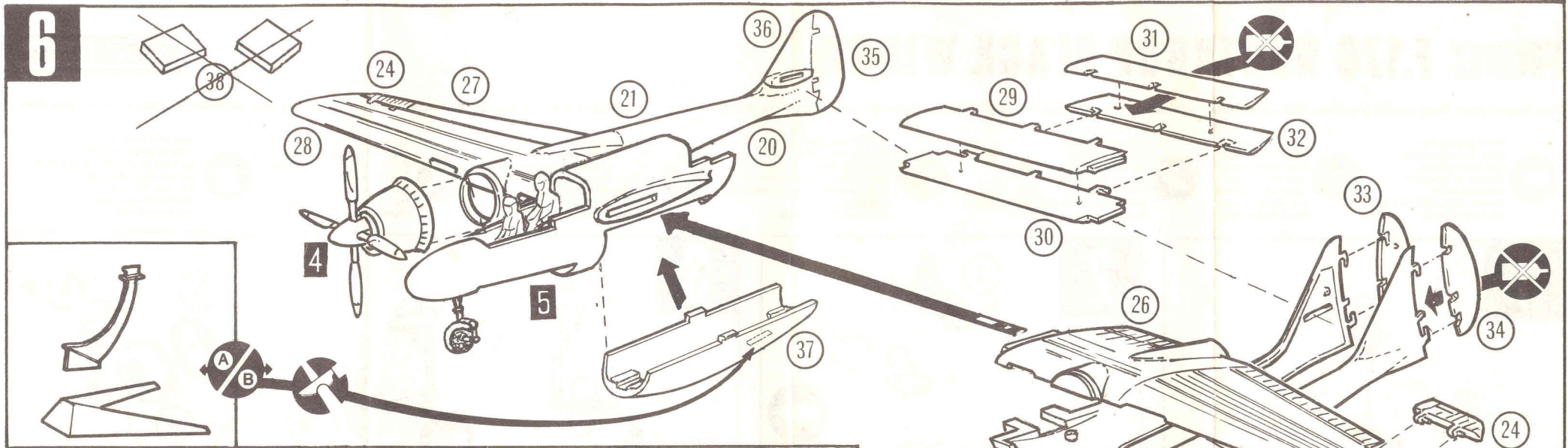
6

Every precaution has been taken to ensure that your kit will reach you complete. If however you find any part is faulty or missing please fill in the details opposite in block letters and return the slip to:

**ROVEX LIMITED,
SERVICE DEPARTMENT,
WESTWOOD, MARGATE,
KENT, ENGLAND.**

Please give the Number of the Part shown in the exploded assembly diagram in this instruction leaflet.

F.170 Black Widow **B**

No. of Part

.....

PLEASE USE BLOCK LETTERS

Name

Address

.....

.....

.....