



LEVEL 4

1 2 3 4 5



HMS KING GEORGE V

Beiliegenden Sicherheitstext beachten / Please note the enclosed safety advice

- DE Beiliegenden Sicherheitstext beachten und nachschlagbereit halten.
- GB Please note the enclosed safety advice and keep safe for later reference.
- FR Respecter les consignes de sécurité ci-jointes et les conserver à portée de main.
- NL Houdt u aan de bijgaande veiligheidsinstructies en hou deze steeds bij de hand.
- IT Seguire le avvertenze di sicurezza allegate e tenerle a portata di mano.
- ES Observar y siempre tener a disposición este texto de seguridad adjunto.
- PT Ter em atenção o texto de segurança anexo e guardá-lo para consulta.
- DK Overhold vedlagte sikkerhedsanvisninger og hav dem liggende i nærheden.
- NO Ha alltid vedlagt sikkerhetstekst klar til bruk.
- SE Beakta bifogad säkerhetstext och håll den i beredskap.
- FI Huomioi ja säilytä oheiset varoitukset.
- RU Соблюдать технику безопасности, сохранить инструкцию для дальнейших обращений.
- PL Przestrzegać załączonego tekstu dotyczącego bezpieczeństwa i mieć go zawsze pod ręką.
- CZ Dodržujte tento příložený bezpečnostní text a mějte ho po ruce.
- HU A mellékelt biztonsági szöveget vegye figyelembe és tartsa fellapozásra készen.
- SK Rešpektujte priložený bezpečnostný text a uchovajte ho pre budúce použitie.
- RO Respectați textul de siguranță atașat și păstrați-l la îndemână.
- BG Спазвайте приложения текст за безопасност и го дръжте под ръка за справки.
- SJ Prilolena varnostna navodila izvajajte in jih hranite na vsem dostopnem mestu.
- GR Λάβετε υπόψη σας το συνημμένο κείμενο ασφαλείας και φυλάξτε το ώστε να ανατρέχετε σε αυτό όποτε χρειάζεται.
- TR Ektekiğüvenlik talimatlarını dikkate alıp, bakabileceğiniz bir şekilde muafaza ediniz.



☞ Weitere Tipps und Tricks.
 ☞ Additional tips and tricks.
 ☞ Conseils et astuces supplémentaires.
 ☞ Andere tips en trucs.
 ☞ Ulteriori consigli e suggerimenti.
 ☞ Consejos y sugerencias adicionales.
 ☞ Mais dicas e truques.

☞ Flere tips og tricks.
 ☞ Flere tips og tricks.
 ☞ Ytterligare tips och tricks.
 ☞ Lisää vinkkejä ja niksejä.
 ☞ Другие советы и хитрости.
 ☞ Dalsze wskazówki i sugestie.
 ☞ Další tipy a rady.
 ☞ További ötletek és fogások.
 ☞ Dalsie tipy a triky.
 ☞ Alte sfaturi și trucuri.

☞ Други полезни съвети и трикове.
 ☞ Nadaljnji nasveti in zvižaje.
 ☞ Πρόσθετες συμβουλές και κόλπα.
 ☞ Diğer öneriler ve ipuçları.

www.revell.de



- DE Kleben
- GB Glue
- FR Coller
- NL Lijmen
- IT Incollare
- ES Pegamento
- PT Colar
- DK Lim
- NO Lime
- SE Limma
- FI Liimaa
- RU Клеить
- PL Przykleić
- CZ Slepění
- HU Ragassza rá
- SK Lepiť
- NO Lipiti
- GB Залепете
- SI Prilepite
- GR ΚΟΛΛΗΣΕΤΕ
- TR Yapıştırma



- DE Nicht kleben
- GB Don't glue
- FR Ne pas coller
- NL Niet lijmen
- IT Non incollare
- ES No pegamento
- PT Não colar
- DK Lim ikke
- NO Ikke lime
- SE Limma inte
- FI Älä liimaa
- RU Не клеить
- PL Nie przyklejać
- CZ Nelepít
- HU Ne ragassza rá
- SK Nelepít
- NO Nu lipiti
- GB Не лепете
- SI Ne lepíte
- GR Μην κολλήσετε
- TR Yapıştırmayın



- DE Bemalen
- GB Paint
- FR Peindre
- NL Beschilderen
- IT Colorare
- ES Pintar
- PT Pintar
- DK Mal
- NO Male
- SE Måla
- FI Maalaa
- RU Ракрасить
- PL Pomalować
- CZ Pomalovat
- HU Fesse be
- SK Natrief
- NO Vopsiți
- GB Боядисайте
- SI Robarvajte
- GR Βάψτε
- TR Boyama



- DE Zusammenbau Reihenfolge.
- GB Sequence of assembly.
- FR Ordre d'assemblage.
- NL Volgorde van montage.
- IT Sequenza di assemblaggio.
- ES Secuencia de montaje.
- PT Sequência de montagem.
- DK Samlerækkefølge.
- NO Monteringsrekkefølge.
- SE Monteringsordningsföljd.
- FI Kokoamisjärjestys.
- RU Последовательность сборки.
- PL Kolejność montażu.
- CZ Pořadí složení.
- HU Összerakási sorrend.
- SK Poradie zostavenia.
- NO Ordinea asamblării.
- GB Последовательность на сглобяване.
- SI Vrstni red sestavljanja.
- GR Σειρά τοποθέτησης.
- TR Parçaları birleştirme sırası.



- DE Abbildung zusammengesetzter Teile.
- GB illustration of assembled parts.
- FR Figure représentant les pièces assemblées.
- NL Afbeelding van samengevoegde onderdelen.
- IT Foto delle parti assemblate.
- ES Figura de las piezas montadas.
- PT Ilustração das peças montadas.
- DK Illustration af samlede dele.
- NO Figur av sammensatte deler.
- SE Bild på sammansatta detaljer.
- FI Koottujen osien kuva.
- RU Изображение смонтированных деталей.
- PL Rysunek połączonych części.
- CZ Zobrazení spojených dílů.
- HU Összerakott alkatrészek ábrája.
- SK Obrázok dielov, ktoré sa majú zmontovať.
- NO Figura reprezentând piesele asamblate.
- GB Изображение на сглобените части.
- SI Slika sestavljenih delov.
- GR Απεικόνιση των τοποθετημένων μερών.
- TR Birleştirilmiş parçalar resmi.



- DE Mit Klebeband fixieren.
- GB Attach with adhesive tape.
- FR Fixer à l'aide de ruban adhésif.
- NL Met plakband vastzetten.
- IT Fissare con nastro adesivo.
- ES Fijar con cinta adhesiva.
- PT Fixar com fita adesiva.
- DK Fastgør med tape.
- NO Fest med tape.
- SE Fixera med tejp.
- FI Kiinnittää liimanauhalla.
- RU Зафиксировать липкой лентой.
- PL Przy mocować za pomocą taśmy samoprzylepnej.
- CZ Pripevněte lepicí páskou.
- HU Rögzítse ragasztószalaggal.
- SK Fixujte lepiacou páskou.
- NO Fixați cu bandă adezivă.
- GB Фиксирайте с тиксо.
- SI Pritrdite z lepilnim trakom.
- GR Στερεώσατε κολλητική ταινία.
- TR Yapıştırma bandı ile sabitleyin.



- DE Wegfeilen
- GB File off
- FR Enlever avec une lime
- NL Wegvijlen
- IT Rimuovere con una lima
- ES Limar
- PT Remover com uma lima
- DK Fil af
- NO File av
- SE Skall filas bort
- FI Hio pois
- RU Сточить напильником
- PL Odrpłować
- CZ Odrpílovat
- HU Reszelje le
- SK Odrpílovať
- NO Pliiți
- GB Изпилете
- SI Odrpilate
- GR Λιμάρτε
- TR Zımparalama



- DE Abziehbild in Wasser einweichen und anbringen.
- GB Soak and apply decals.
- FR Mouiller et appliquer les décalcomanies.
- NL Transfer in water even laten weken en aanbrengen.
- IT Immergere la decalcomania nell'acqua e applicarla.
- ES Mojar y aplicar calcomanías.
- PT Amolecer o decalque em água e aplicar.
- DK Gør overføringsbilledet vådt og sæt det på.
- NO Myk opp avtrekkingsbildet i vann og sett på.
- SE Blötlägg dekalen i vatten och sätt på den.
- FI Pehmitä siirtokuva vedessä ja siirrä raikalleen.
- RU Опустите переводную картинку в воду и нанесите её.
- PL Namoczyć kalkomanię w wodzie i przykleić.
- CZ Nechte obtisk odmočit ve vodě a přilepte.
- HU Merítse vízbe és helyezze fel a matricát.
- SK Odtlačkový obrázok namočte do vody a priložte na plochu.
- NO Innuiazi abtjibildul in apă și aplicați-l.
- GB Потопете ваденката във вода и я поставете.
- SI Pri nameščanju nalepnice priporočamo.
- GR Μουσκεψτε σε νερό και τοποθετήστε τις χαλκομανίες.
- TR Çikartmayı suda yumuşatın ve takın.



- DE Zur Anbringung der Abziehbilder empfohlen.
- GB Recommended for affixing the decals.
- FR Recommandé pour l'application des décalcomanies.
- NL Aanbevolen voor het aanbrengen van de transfers.
- IT Raccomandato per l'applicazione delle decalcomanie.
- ES Recomendado para fijar bien las calcomanías.
- PT Recomendado para a fixação dos autocolantes.
- DK Anbefales til anbringelse af overføringsbillederne.
- NO Anbefales til å feste avtrekkingsbilder.
- SE Rekommenderad för montering av klisterdekalerna.
- FI Suositellaan siirtokuvien siirtämiseen.
- RU Рекомендуется для нанесения переводных картинок.
- PL Zalecane do przyklejenia kalkomanii.
- CZ Doporučujeme k umístění obtiskovacích obrázků.
- HU A matrica felhelyezéséhez ajánlható.
- SK Odporúčame sa pre umiestnenie odtlačkového obrázku.
- NO Recomandat pentru aplicarea abtjibildurilor.
- GB Препоръчва се за поставяне на ваденки.
- SI Pri nameščanju nalepnice priporočamo.
- GR Συνιστάται για την τοποθέτηση των χαλκομανιών.
- TR Çikartmaların takılması için önerilir.



- DE Nicht enthalten
- GB Not included
- FR Non fourni
- NL Behoort niet tot de levering
- IT Non incluso
- ES No incluido
- PT Não incluído
- DK Medfølger ikke
- NO Ikke inkludert
- SE Ingår ej
- FI Ei sisällä
- RU Не содержится
- PL Nie wchodzi w zakres dostawy
- CZ Není obsaženo
- HU Nem tartalmazza
- SK Neobsahuje
- NO Nu este inclus
- GB Не се включва в комплекта
- SI Ni priloženo
- GR Δεν περιλαμβάνεται
- TR İçermiyor

Benötigte Farben / Required colours

- FR Peintures nécessaires
- NL Benodigde kleuren
- IT Colori necessari
- ES Colores necesarios
- PT Cores necessárias
- DK Nødvendige farver
- NO Nødvendige farger
- SE Erforderliga färger
- FI Tarvittavat värit
- RU Необходимые краски
- PL Potrzebne kolory
- CZ Potřebné barvy
- HU Szükséges színek
- SK Požadované farby
- RO Colori necesare
- BG Необходими цветове
- SI Potrebne barve
- GR Απαιτούμενα χρώματα
- TR Gerekli renkler

57

A

- DE Grau matt
- GB Grey matt
- FR Gris mat
- NL Grijs mat
- IT Grigio opaco
- ES Gris mate
- PT Cinzento mate
- DK Grå mat
- NO Grå matt
- SE Grå matt
- FI Harmaa matta
- RU Серый матовый
- PL Szary matowy
- CZ Šedá matný
- HU Szürke, fénytelen
- SK Sivá matný
- RO Gri mat
- BG Сиво матово
- SI Siva mat
- GR Γκρι ματ
- TR Gri mat

75

B

- DE Steingrau matt
- GB Stone grey matt
- FR Gris pierre mat
- NL Steengrijs mat
- IT Grigio pietra opaco
- ES Gris piedra mate
- PT Cinza pedra mate
- DK Stengrå mat
- NO Stengrå matt
- SE Stengrå matt
- FI Kivenharmaa matta
- RU Серый камень матовый
- PL Kamiennoszary matowy
- CZ Kamenná šedá matný
- HU Kőszürke, fénytelen
- SK Kamenná sivá matný
- RO Gri stâncos mat
- BG Каменносиво матово
- SI Kameno-siva mat
- GR Γκρι-μπεζ ματ
- TR Taş grisi mat

77

C

- DE Staubgrau matt
- GB Dusty grey matt
- FR Gris poussière mat
- NL Stofgrijs mat
- IT Grigio polvere opaco
- ES Gris polvo mate
- PT Cinza pó mate
- DK Støvet grå mat
- NO Støvgrå matt
- SE Dammgrå matt
- FI Tomunharmaa matta
- RU Серая пыль матовый
- PL Szary stalowy matowy
- CZ Prachová šed matný
- HU Porszürke, fénytelen
- SK Prachová sivá matný
- RO Gri prăfuit mat
- BG Прашносиво матово
- SI Prašno-siva mat
- GR Σταχτί ματ
- TR Duman grisi mat

88

D

- DE Ocker matt
- GB Ochre matt
- FR Ocre mat
- NL Oker mat
- IT Ocra opaco
- ES Ocre mate
- PT Ocre mate
- DK Okkerbrun mat
- NO Okkerbrun matt
- SE Ockrabrun matt
- FI Okranruskea matta
- RU Охра матовый
- PL Ochra matowy
- CZ Okr hnědý matný
- HU Okker, fénytelen
- SK Okrová matný
- RO Ocro mat
- BG Охра матово
- SI Oker mat
- GR Ωχρα ματ
- TR Toprak rengi mat

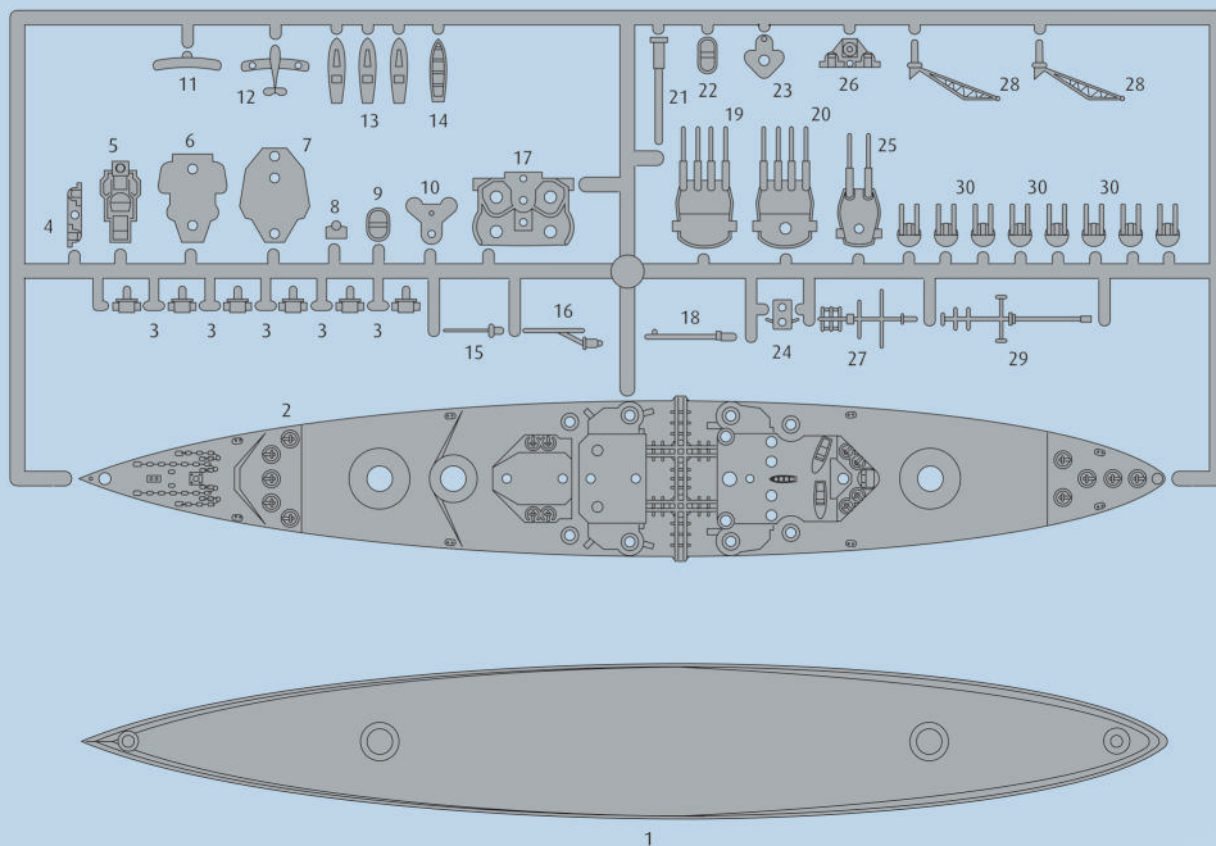

Ersatzteile benötigt?

Kein Problem. Einfach den Revell-Service mit Angabe von Artikel- und Teilenummer kontaktieren. Entweder unter service@revell.de oder Revell GmbH, Abteilung X, Henschelstr. 20-30, 32257 Bünde.*

*Wir bitten um Verständnis, dass eine Gewährleistung nur bei aktuellen Artikeln, die im Zeitraum der letzten 24 Monate erworben wurden, übernommen werden kann. Mit der Ersatzteil-Bestellung können Kosten z.B. für Verpackung und Versand entstehen. Ob diese Kosten anfallen wird im Vorfeld schriftlich durch unseren Service mitgeteilt. Das Angebot kann dann angenommen oder abgelehnt werden. Unfrei eingesandte Ersatzteil-Bestellungen werden von uns nicht angenommen! Dieser Direktservice gilt für die Länder Deutschland, Benelux, Österreich, Frankreich, Großbritannien. Ersatzteil-Bestellungen aus den übrigen Ländern werden über die jeweiligen Distributeure abgewickelt. Bitte kontaktieren Sie Ihren Händler.

Besoin de pièces de rechange ?

Il vous suffit de contacter le service Revell et d'indiquer la référence de l'article et de la pièce. Soit en écrivant par mail à france@revell.de (uniquement pour la France) ou par courrier à Revell GmbH, Département X, Henschelstr. 20-30, D-32257 Bünde.*

*La garantie s'applique pour les articles présents au catalogue et achetés au cours des 24 derniers mois. Merci de votre compréhension. La commande de pièces de rechange peut donner lieu à des frais supplémentaires, par ex. pour l'emballage et le port. Notre service client vous en informera au préalable par écrit. Vous pourrez accepter ou refuser le devis. Nous n'acceptons pas les commandes de pièces de rechange envoyées sans affranchissement ! Ce service direct est valable pour les pays suivants : Allemagne, Benelux, Autriche, France, Grande-Bretagne. Les commandes de pièces en provenance d'autres pays sont traitées par les distributeurs correspondants. Veuillez contacter votre revendeur.

Need spare parts?

No problem. Contact Revell Service with the item number and part numbers you need: service@revell.de or Revell GmbH, Unit 10, Old Airfield Industrial Estate, Cheddington Lane, Tring, Herts, HP23 4QR, Great Britain.*

*We request your understanding that a warranty can only be accepted for current articles which have been purchased in the last 24 months. Orders for spare parts may also be subject to costs for packaging and shipping. You will be notified in advance by our Service department if such costs are incurred. The offer can then be accepted or rejected. We will not be able to process any postal requests unless correct postage has been applied to mailing! This direct service applies to the countries: Germany, Benelux, Austria, France, and the United Kingdom. Spare part orders from other countries are processed by the local distributors. Please contact your dealer.

Hebt u reserveonderdelen nodig?

Geen probleem! Neem eenvoudig contact op met de klantenservice van Revell en geef ons het artikel- en onderdeelnummer door. U kunt ons bereiken op service@revell.de of per post: Revell GmbH, Afdeling X, Henschelstr. 20-30, 32257 Bünde.*

*Wij vragen uw begrip voor de omstandigheid, dat er alleen garantie kan worden geboden voor actuele artikelen, die in de afgelopen 24 maanden zijn gekocht. Met het bestellen van reserveonderdelen kunnen kosten gemoeid zijn, bijv. voor verpakking en verzending. U wordt vooraf schriftelijk door onze klantenservice op de hoogte gesteld als er kosten zouden ontstaan. Het aanbod kan dan worden aangenomen of afgewezen. Wij nemen geen ongefrankeerde bestellingen van reserveonderdelen aan! Deze rechtstreekse service wordt verleend in de landen Duitsland, de Benelux, Oostenrijk, Frankrijk en Groot-Brittannië. Bestellingen van reserveonderdelen in de overige landen worden afgewikkeld via de betreffende distributeurs. Neem hiervoor contact op met uw verkoper.

1

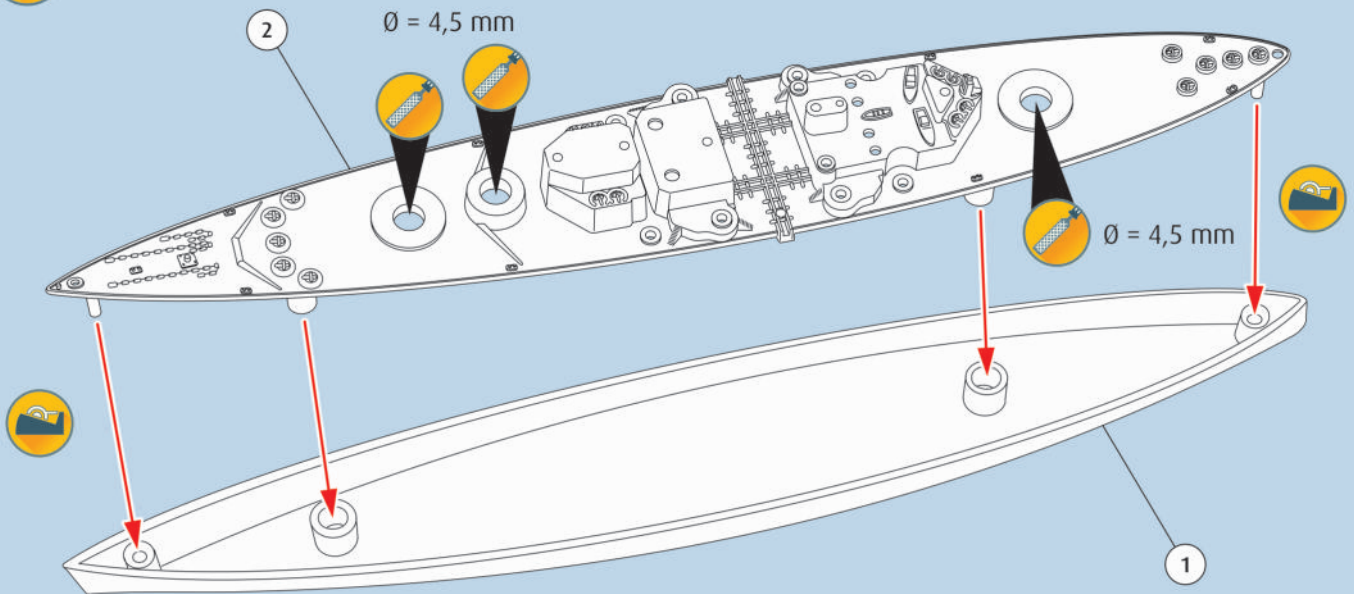

2

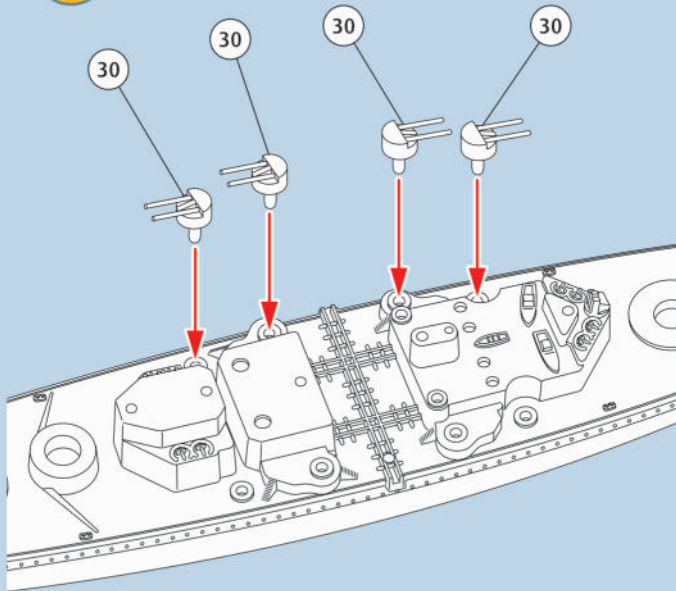

3

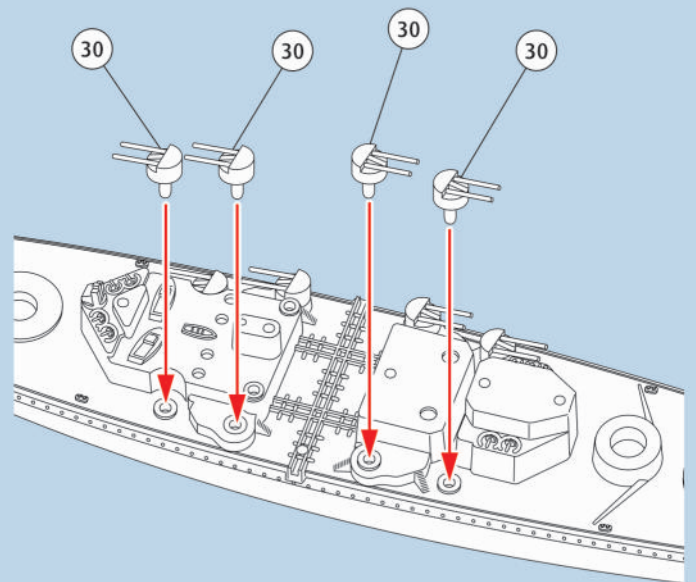

4

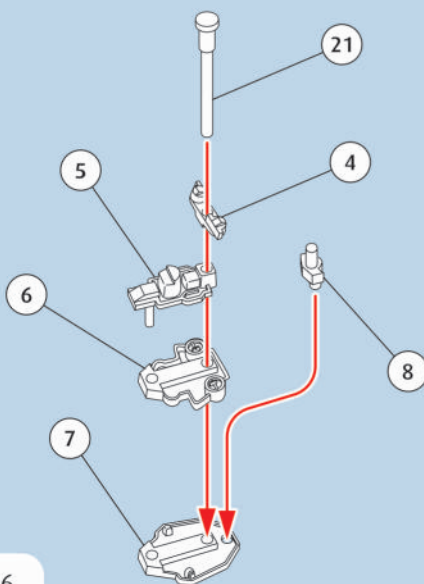

5

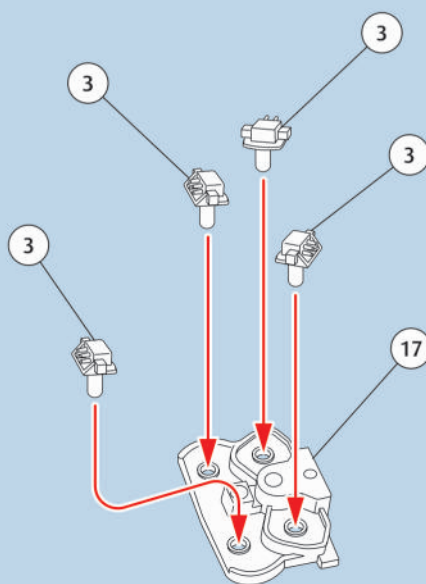

6

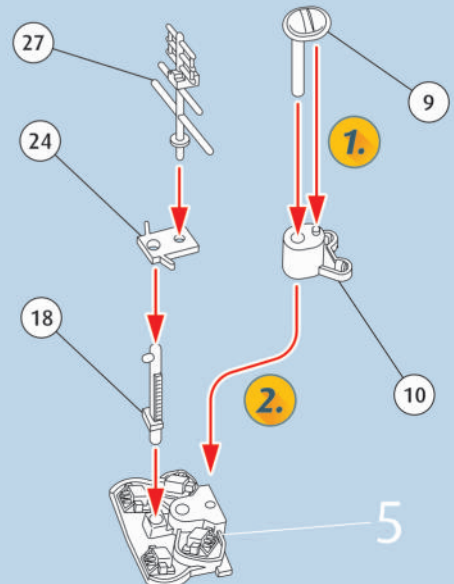

7

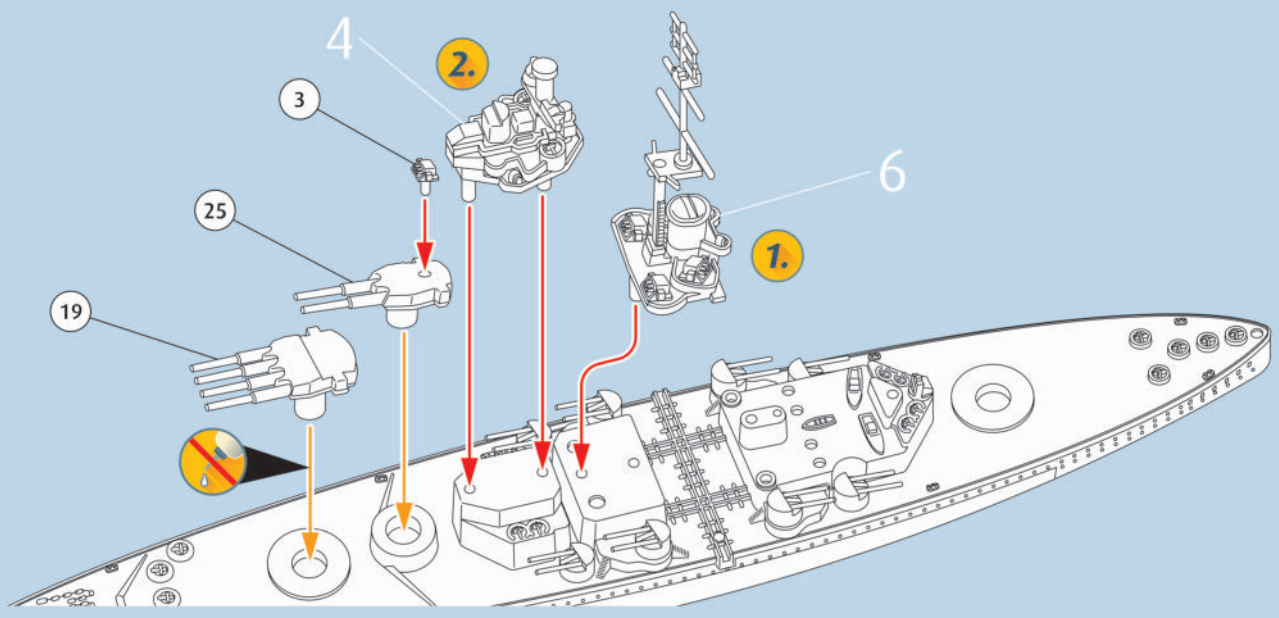

8

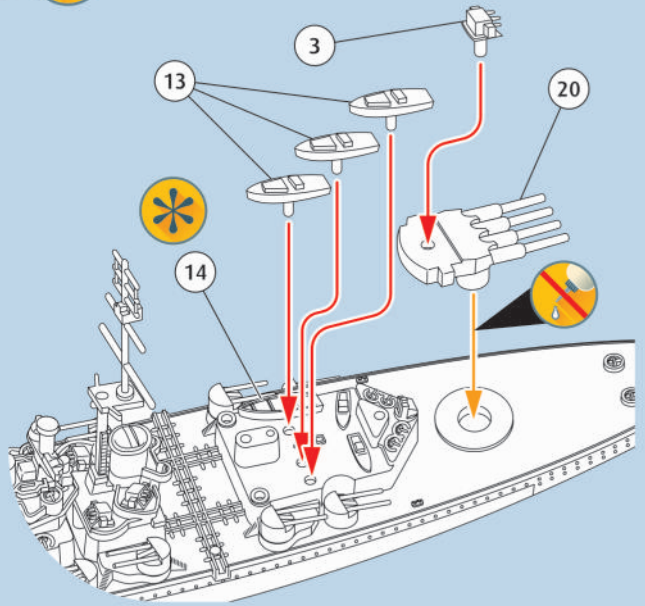

9

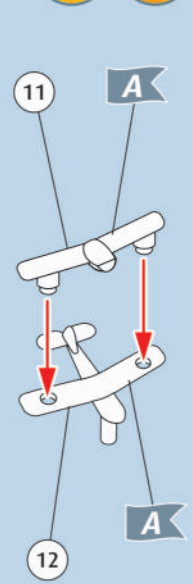

10

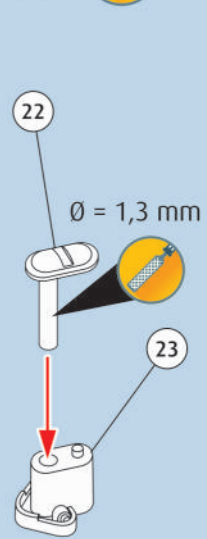

11

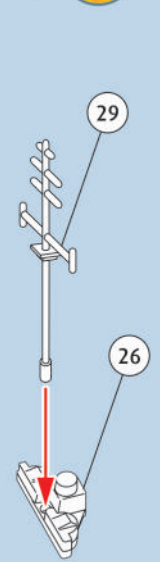

12

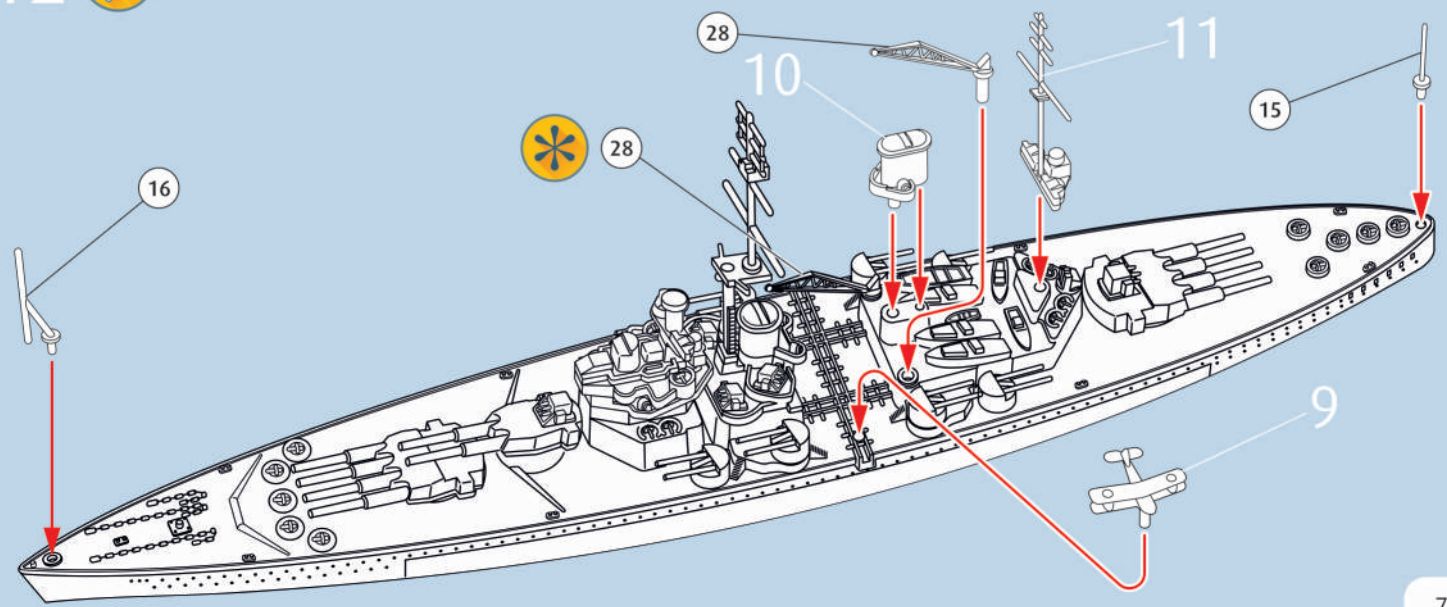



DECAL SHEET

