

**1/48 F-4J Phantom II
INTERIOR 3D* DECAL**

(for Zoukei-Mura SWS kit)

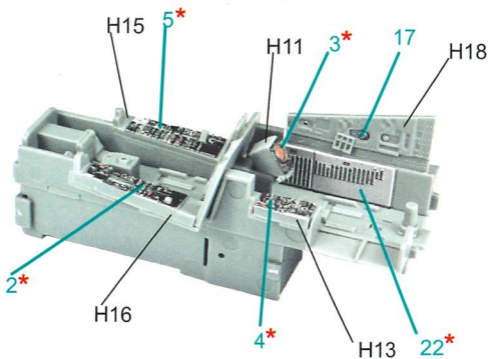

information support by **SCALE MODELS**



A0 - kit's part #

* - remove relief from plastic parts first

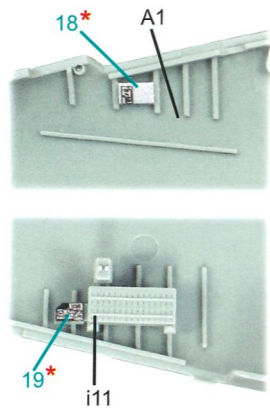
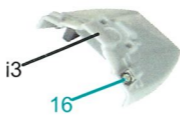
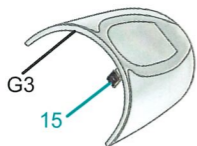
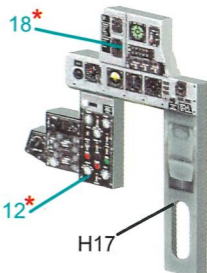
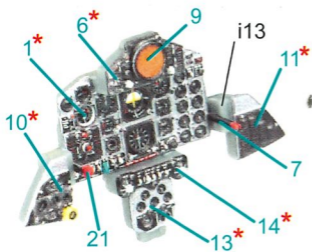

* - apply for both sides

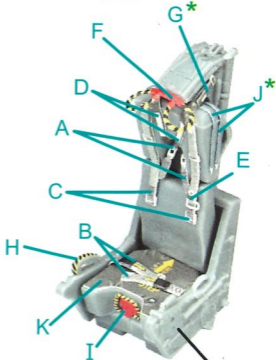

C5+C24+C25+C26+C31