

1/144 SCALE MODEL  
**McDONNELL DOUGLAS F-4E**  
 F-4E

**3**



**READ THIS BEFORE YOU BEGIN NO. 02203**

- Read this instruction sheet carefully before you start to assemble your model.
- Cut the parts off carefully in accordance with the assembling order by use of a nipper or a knife.
- No cement contained in this kit.

**1** Assembling fuselage

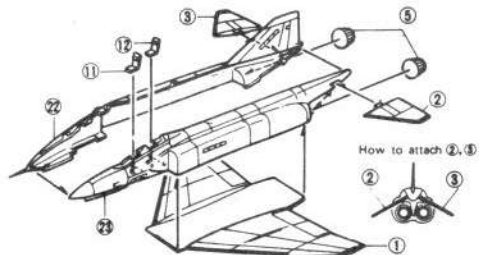

**2** Assembling air intake

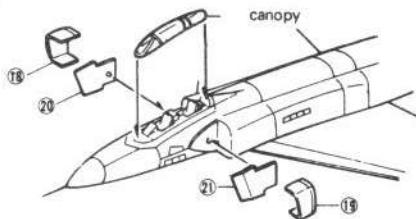

**3** Assembling under fuselage

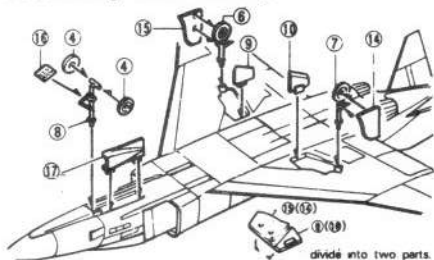

**4** Finish

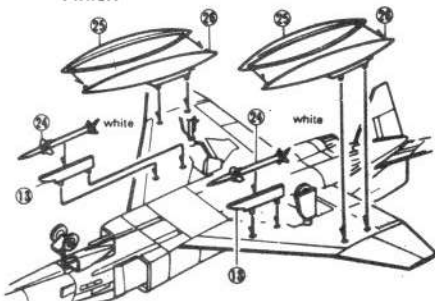

## MARKING & PAINTING

- When you paint model, open windows to let fresh air in
- Never use fire near paint
- Numbers in H' accord with those of  
GUNZE SANGYO AQUEOUS HOBBY COLOR

### ■ How to apply decals.

- 1 Cut them off and soak in water for about 30seconds
- 2 place it together with the base paper at a desired position and slip away the base paper leaving the transfer paper alone, and remove water with dry cloth.

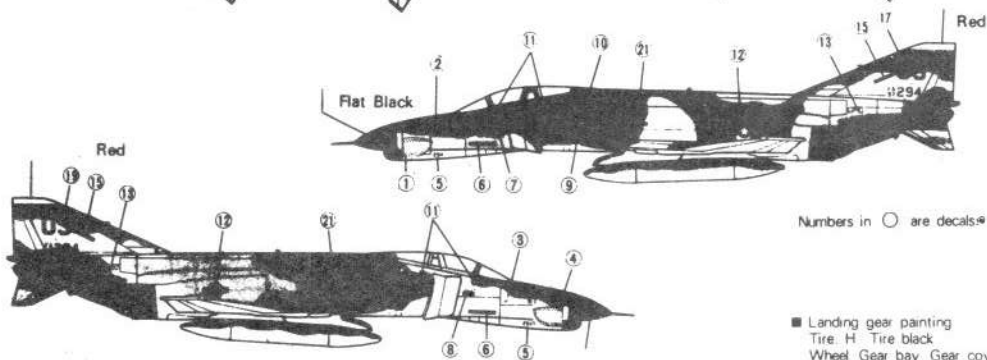
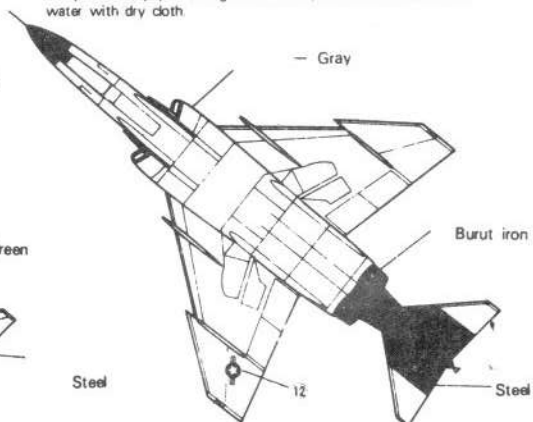
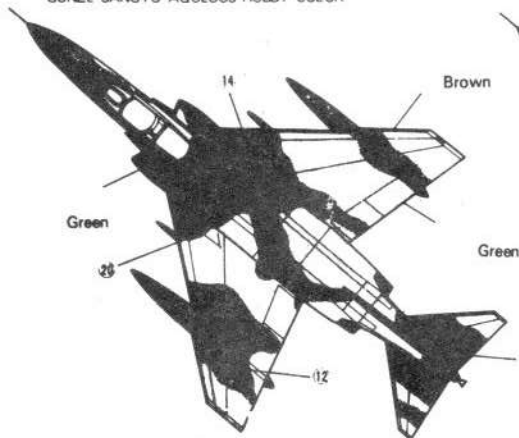

Numbers in ○ are decals<sup>®</sup>

- Landing gear painting
- Tire H Tire black
- Wheel Gear bay Gear cover side
- Gear strut H white

Flat Black



⑱

0	1	2	3	4	5	6	7	8	9
0	1	2	3	4	5	6	7	8	9
0	1	2	3	4	5	6	7	8	9
0	1	2	3	4	5	6	7	8	9

⑰

OS

AF 97 294

⑲

OS

AF 97 294

⑰

0	1	2	3	4	5	6	7	8	9
0	1	2	3	4	5	6	7	8	9

NO. 02203

1/144 F-4E 鬼怪