



**FURBALL**  
 \*\*\* AERO-DESIGN \*\*\*  
**DETAIL & SCALE**



# Colors and Markings of P-47s

**PART**  
 F/D&S-4829

## OPTIONS FOR 20 P-47D/Ms



DECALS PRINTED BY  
**cartoграф**



RESEARCH MATERIALS  
 PROVIDED BY  
**DETAIL & SCALE**  
 www.detailandscale.com





**FURBALL**  
 \*\*\* AERO-DESIGN \*\*\*  
**DETAIL & SCALE**



# Colors and Markings of P-47s

**PART**  
 F/D&S-4829

## OPTIONS FOR 20 P-47D/Ms



DECALS PRINTED BY  
**cartoграф**



RESEARCH MATERIALS  
 PROVIDED BY  
**DETAIL & SCALE**  
 www.detailandscale.com



P-47D-25-RE 42-26421  
66th FTR SQ, 57th FTR GP  
1944



TAIL BANDS ARE 6.35MM TALL

53 (56) WING BANDS ARE 10.4MM WIDE



TOP AND BOTTOM VIEWS FOR "87" & "67"



P-47D-30-RE 44-21043  
CAPT. A.M. WOLBES  
65th FTR SQ, 57th FTR GP  
1945

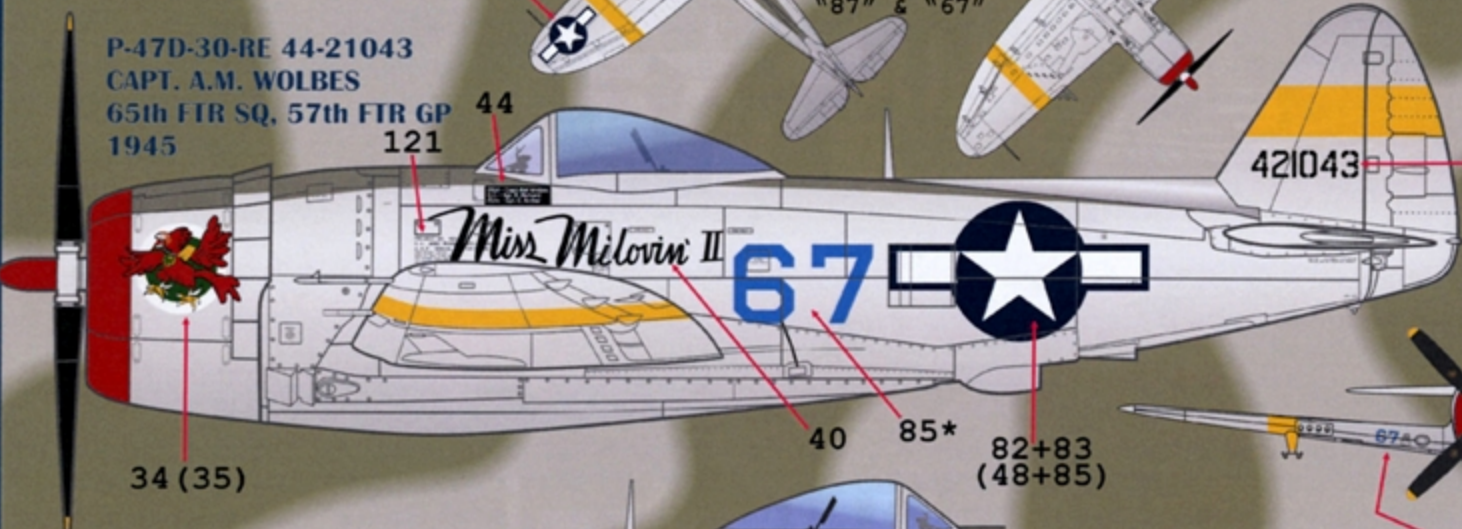

34 (35)



P-47D-26-RA 42-28307  
LT. J. ANGELONE  
66th FTR SQ, 57th FTR GP  
1944

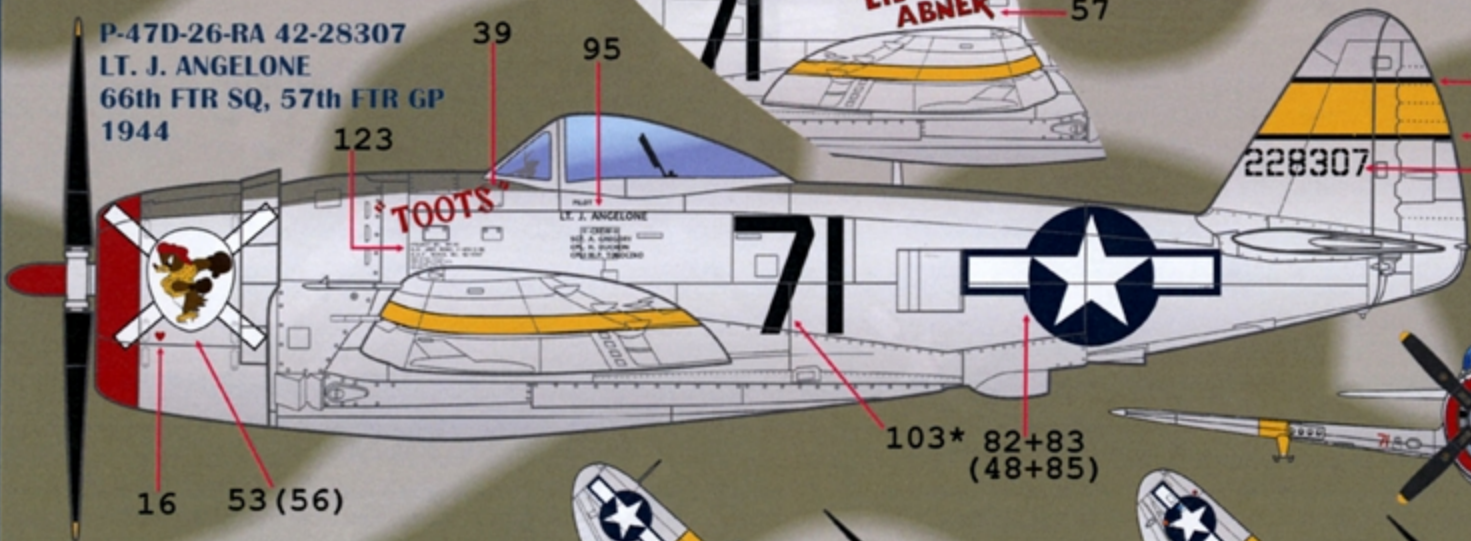

16 53 (56)

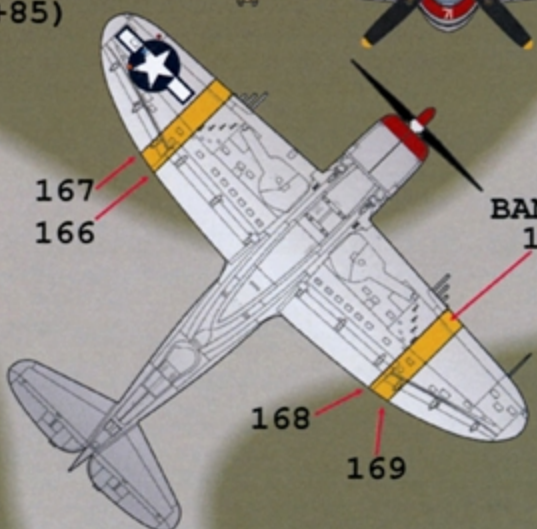
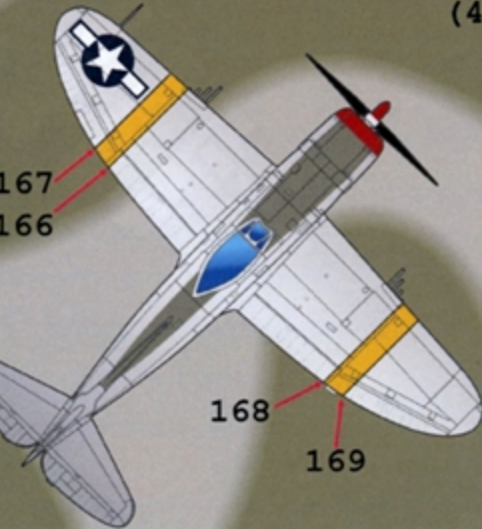

WING BANDS ARE 10.4MM WIDE

FS 11136

FS 33538

FS 34087



NATURAL METAL

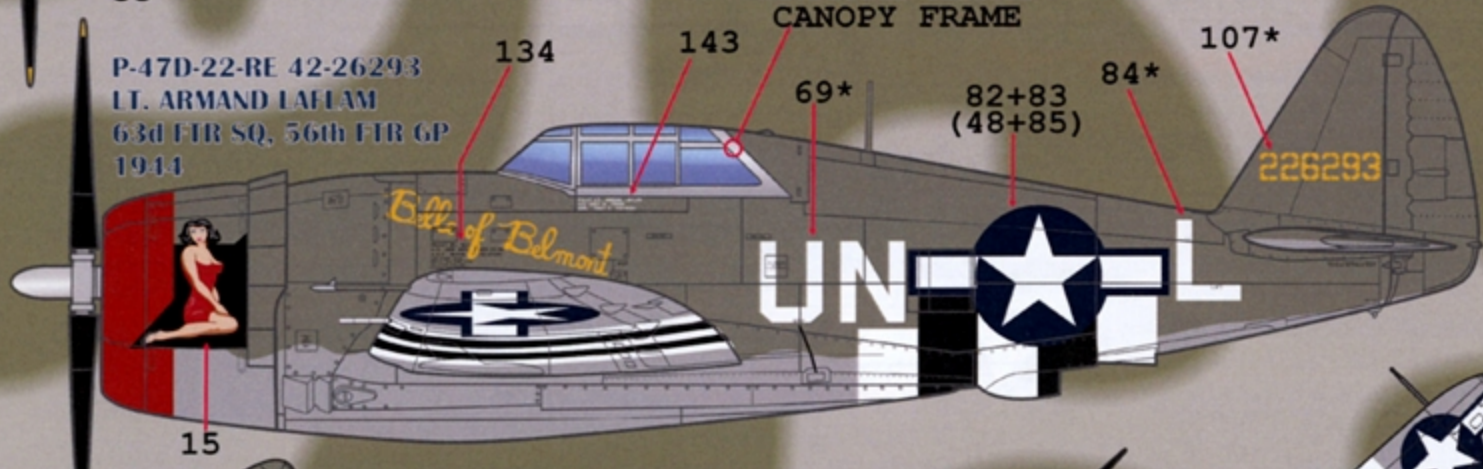
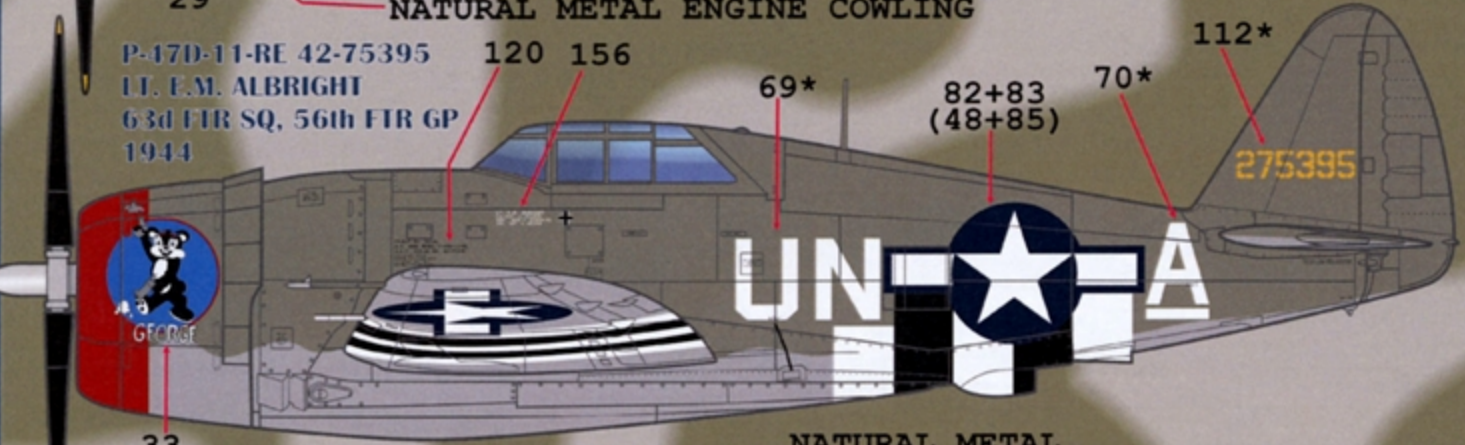
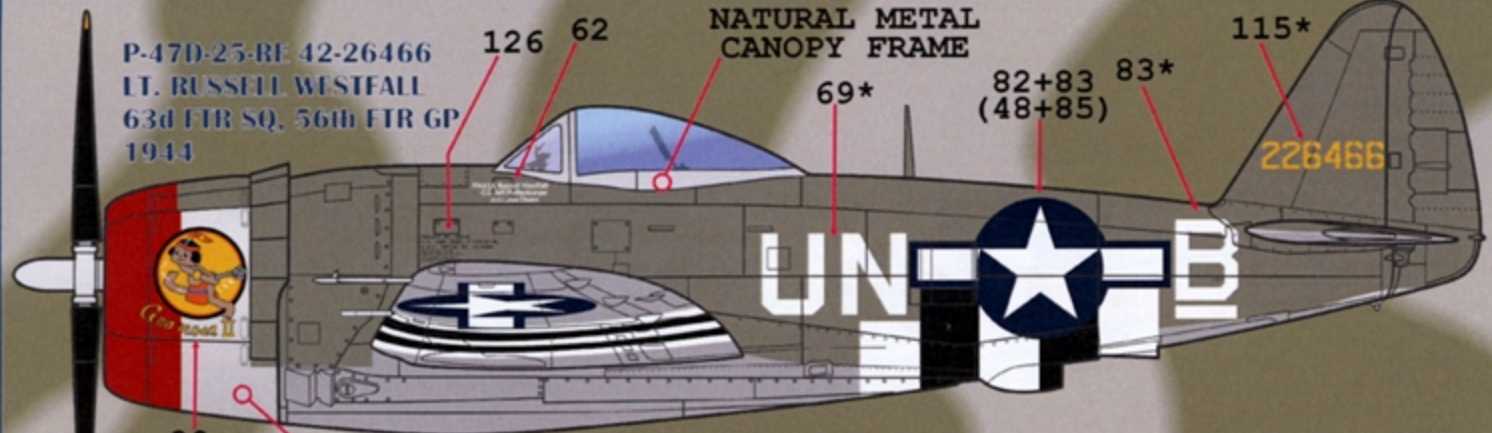



TOP AND BOTTOM  
 MARKINGS ARE COMMON  
 ALL 3 AIRCRAFT

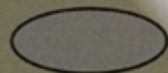

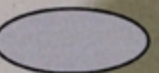
-   
 FS 34087
-   
 FS 11136
-   
 FS 33538
-   
 FS 36270



P-47D-25-RE 42-266S2  
 CAPT. A.F. EATON  
 84th FTR SQ, 78th FTR GP  
 1944

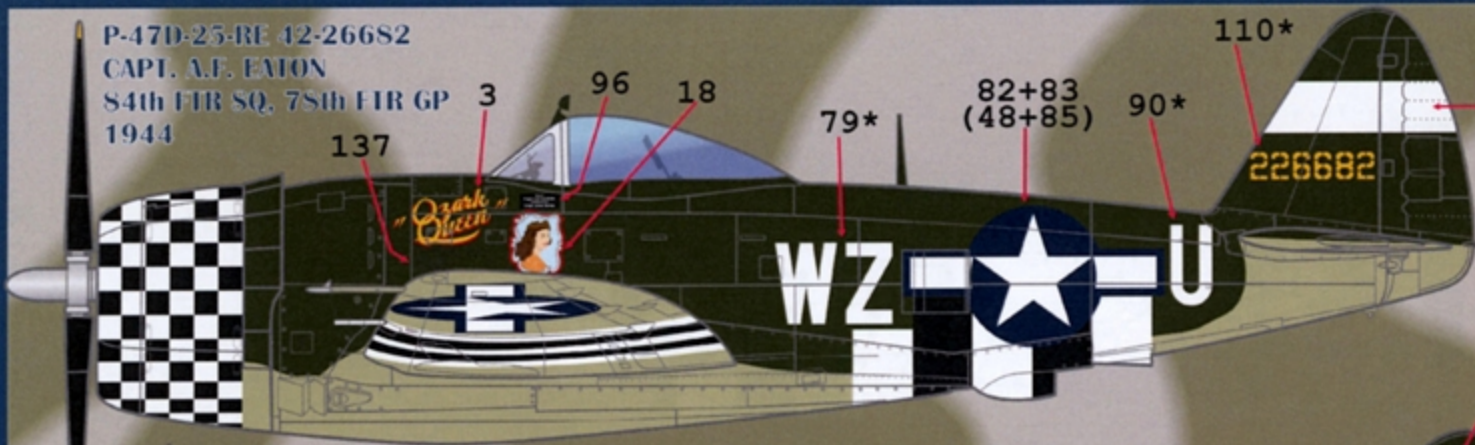

TAIL BAND IS 7.8 MM TALL

TAIL BAND IS 7.8 MM TALL

FLAT BLACK RUDDER

P-47D-28-RA 42-28878  
 LT. F.E. OILER  
 84th FTR SQ, 78th FTR GP  
 Sept 1944

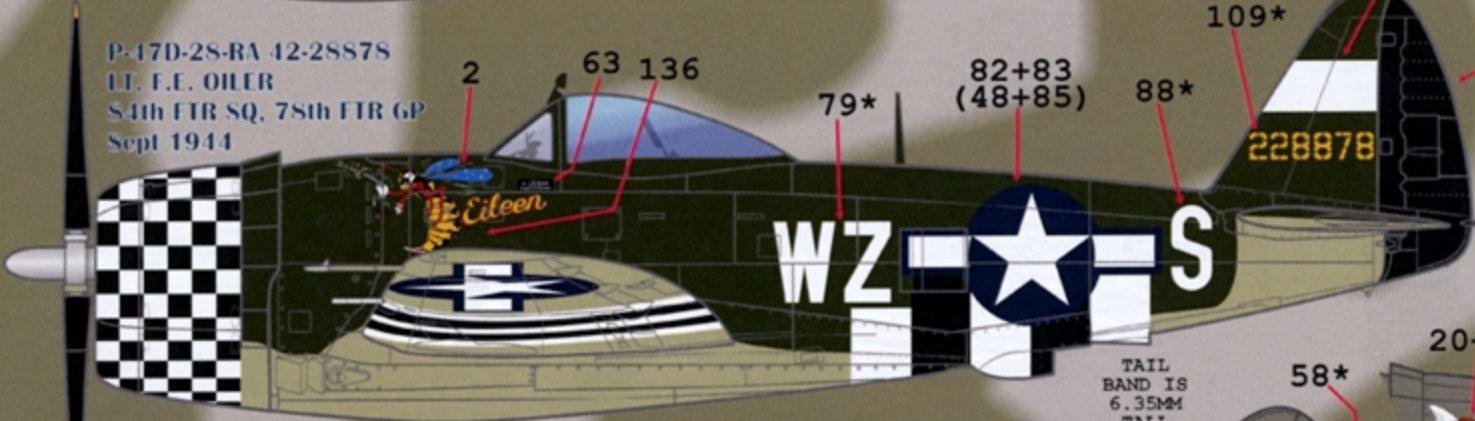

TAIL BAND IS 6.35MM TALL



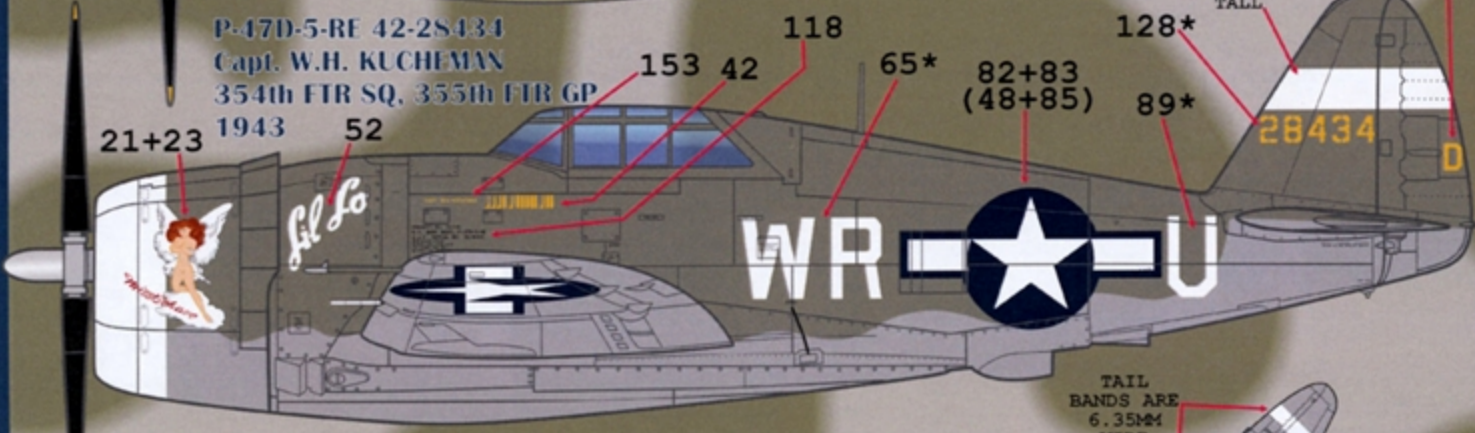

P-47D-5-RE 42-28434  
 Capt. W.H. KUCHEMAN  
 354th FTR SQ, 355th FTR GP  
 1943

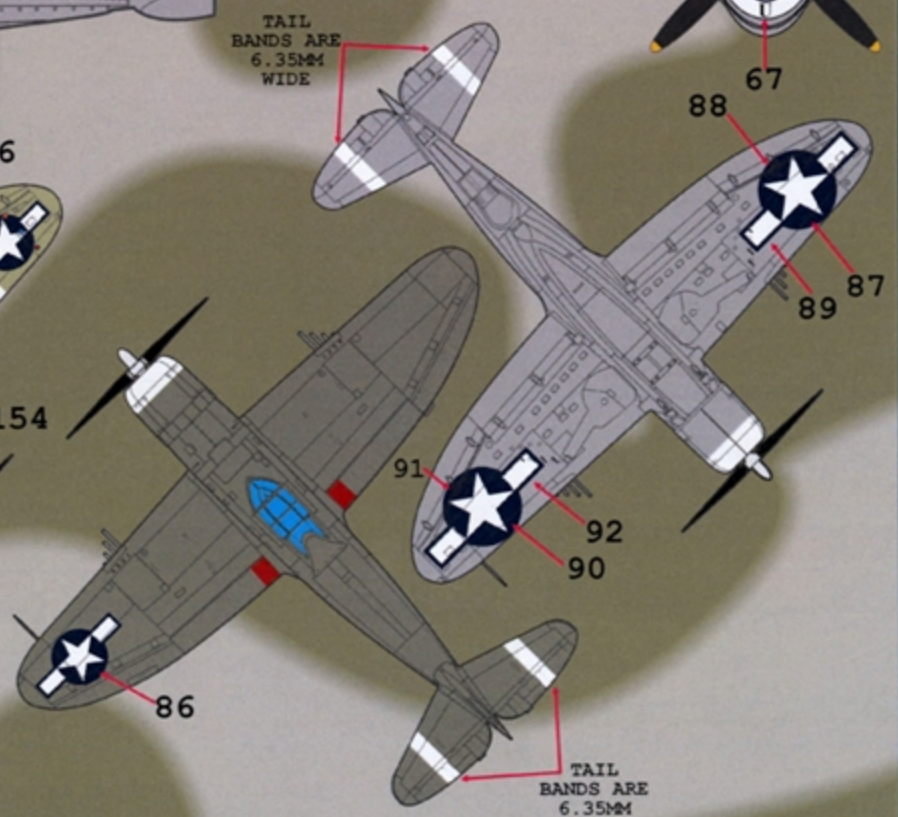
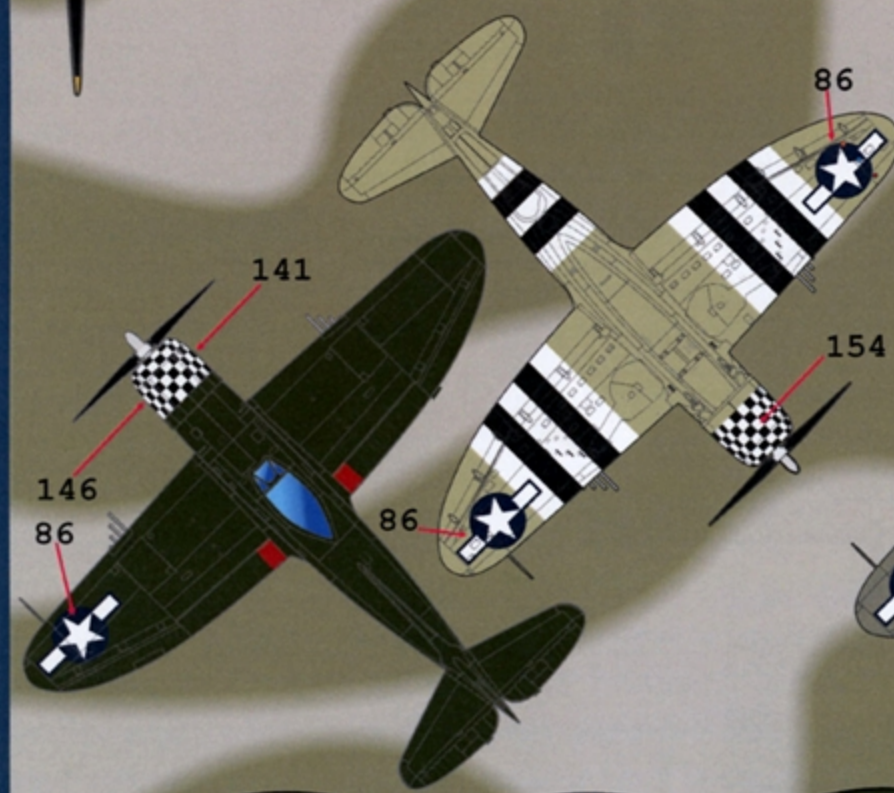
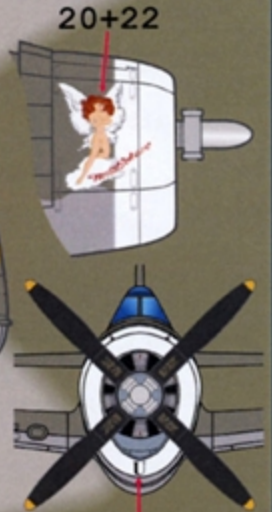

TAIL BANDS ARE 6.35MM WIDE

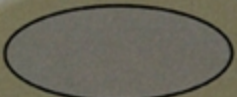
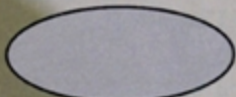

TAIL BANDS ARE 6.35MM WIDE

-   
FS 34087
-   
FS 36270
-   
FS 34096
-   
FS 34424
-   
FS 37875



P-47D-30-RE 44-20473  
 MAJ. G.T. EAGLESTON  
 353d FIR SQ, 351th FIR GP  
 1944

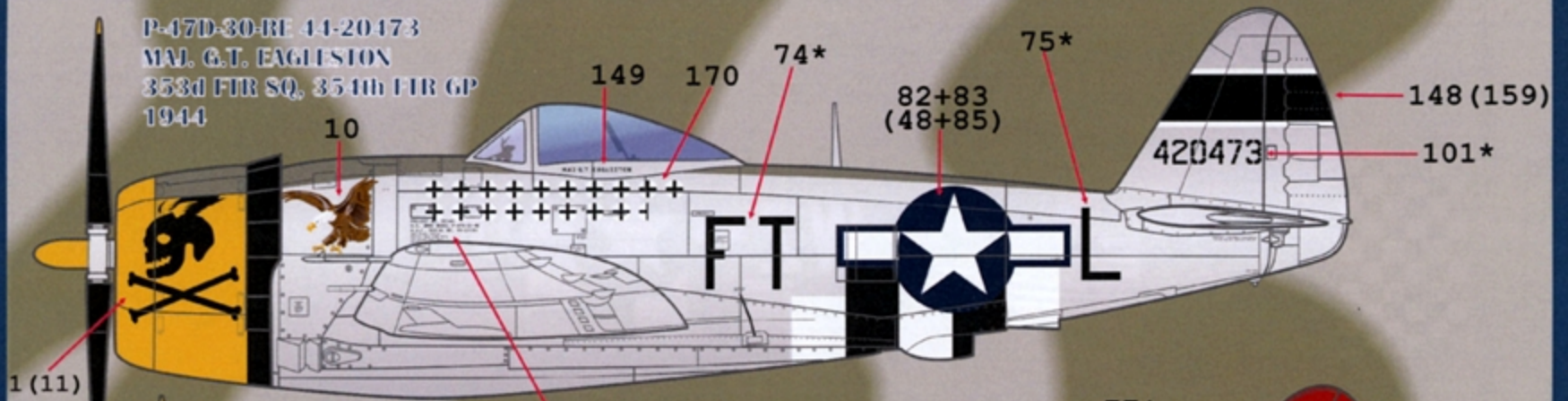

P-47D-27-RE 44-21149  
 CAPT. EDWIN FISHER  
 377th FIR SQ, 362d FIR GP  
 1944

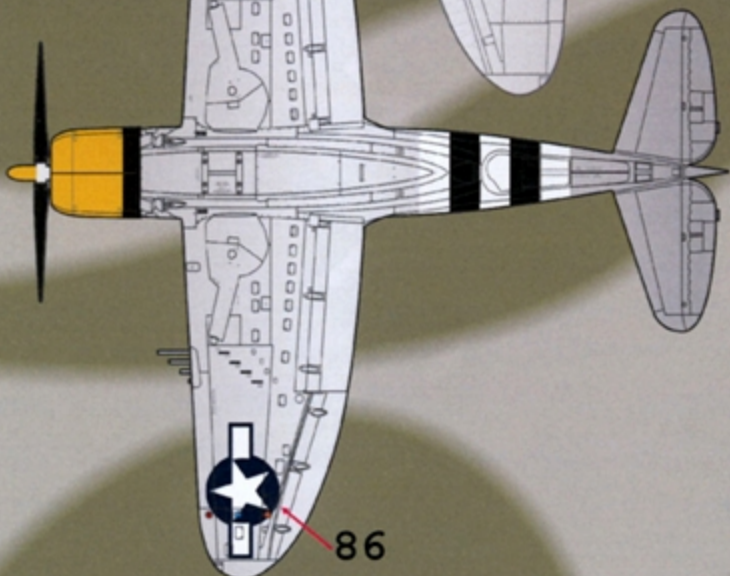
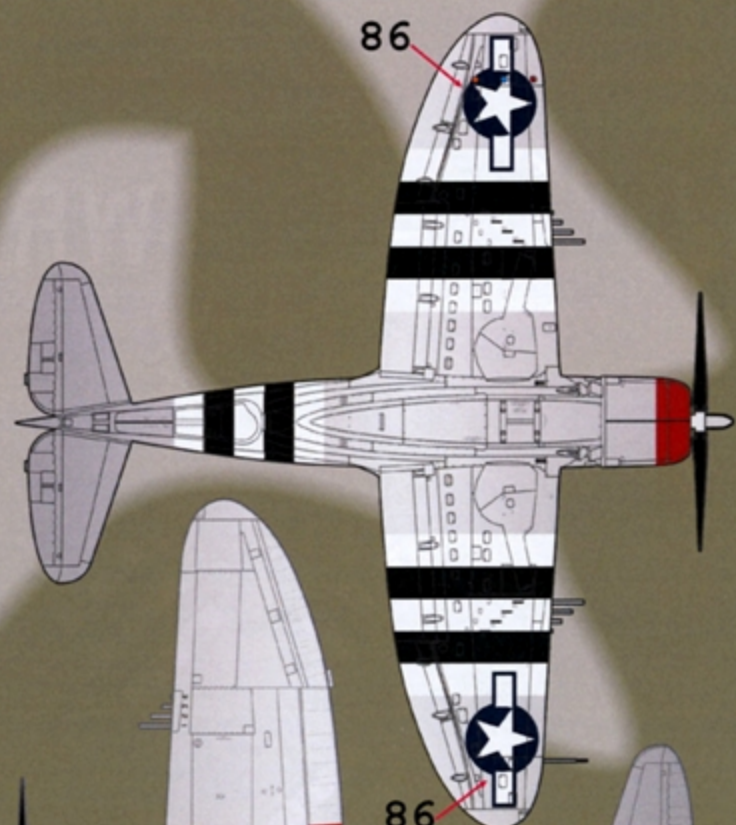
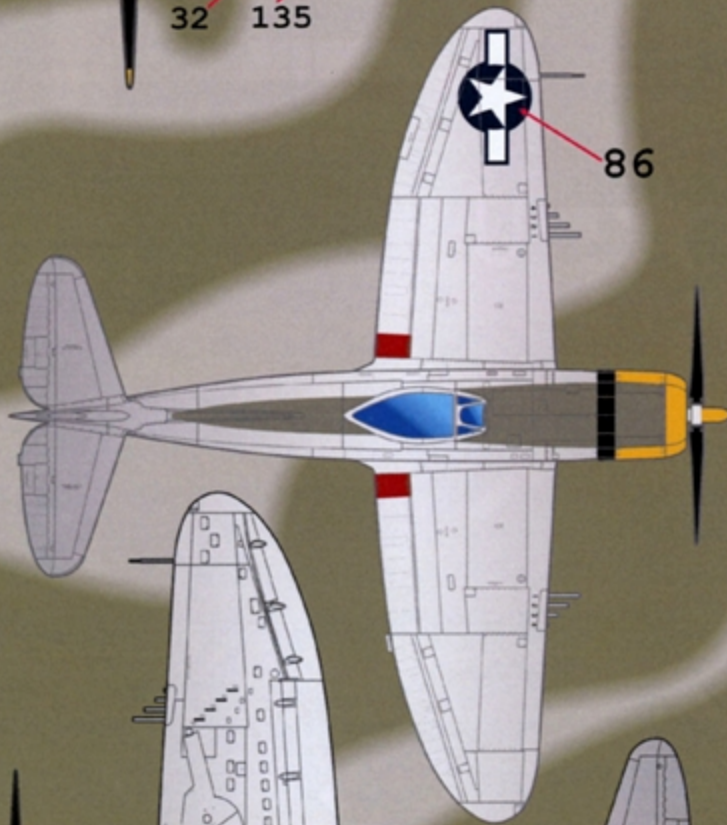
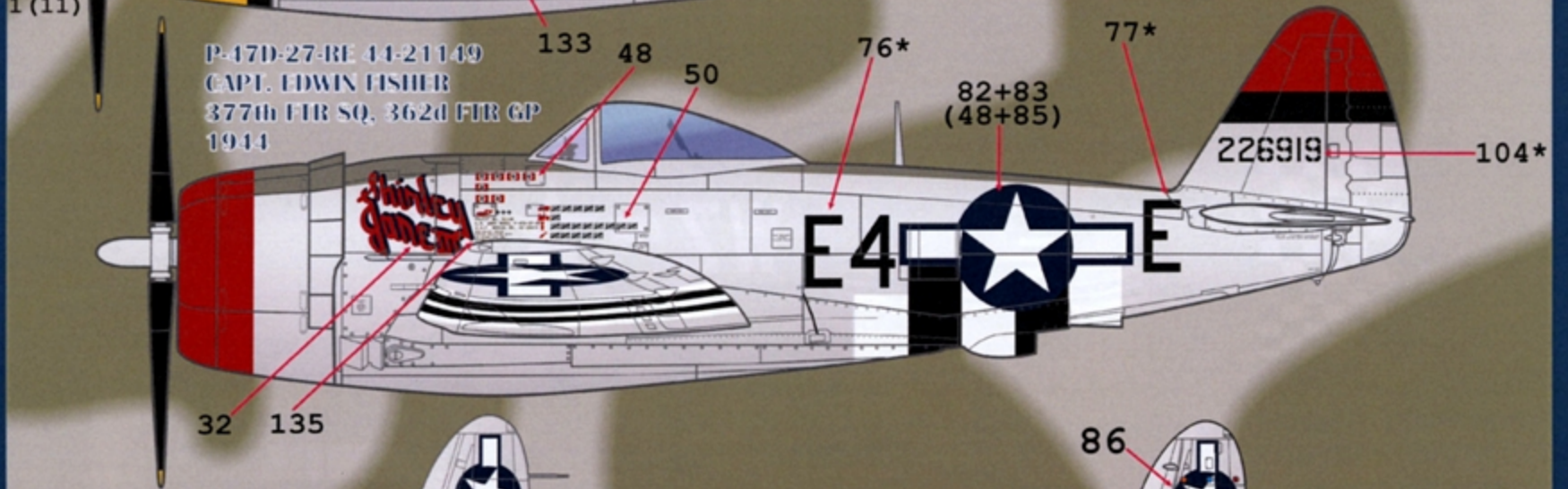

NATURAL METAL FS 34087

FS 17038 FS 33538 FS 11136



P-47M-1-RE 44-21127  
 MAJ. B. GLADYCH  
 61st FIR SQ, 56th FIR GP  
 1945

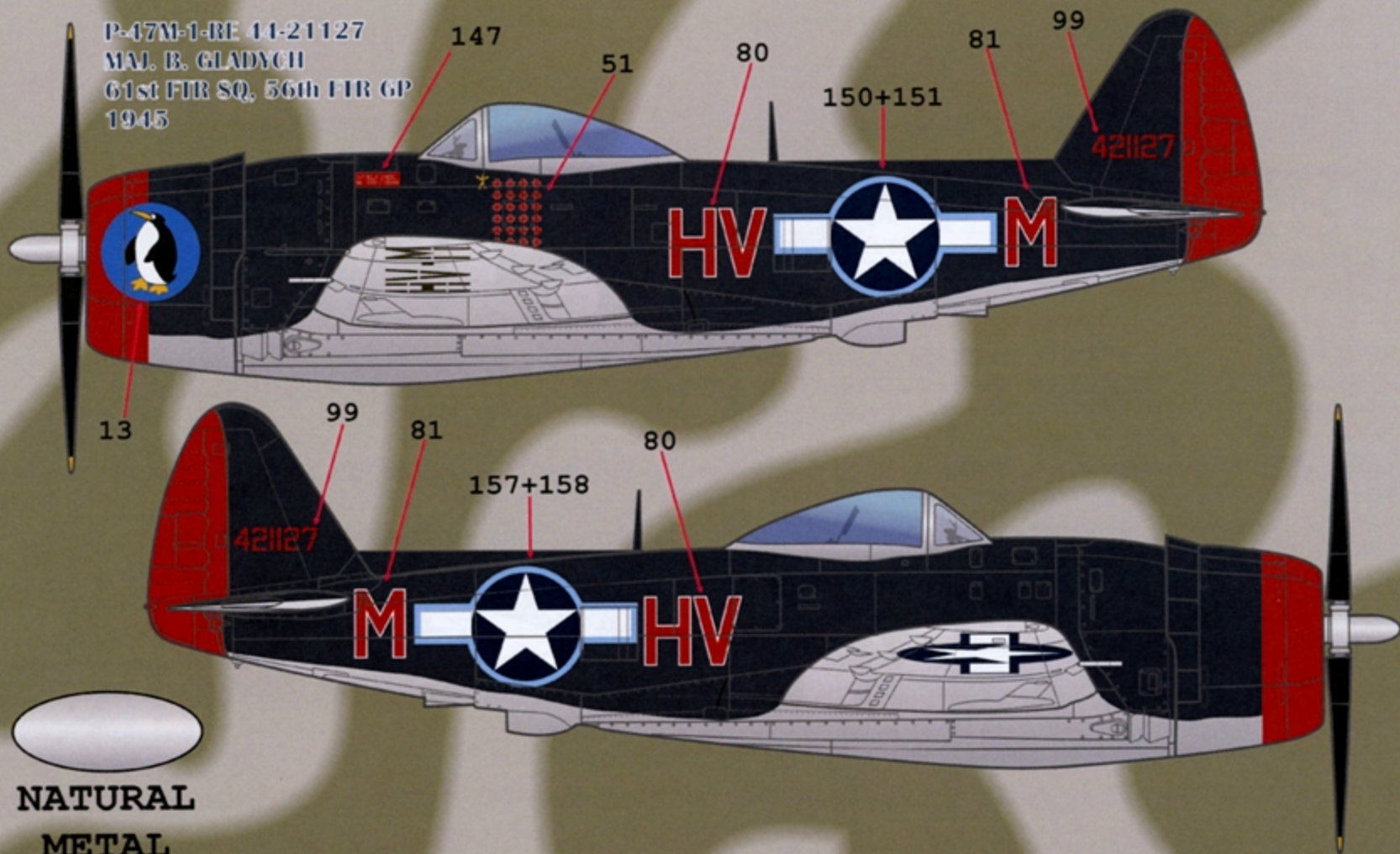

NATURAL  
 METAL



FS 11136

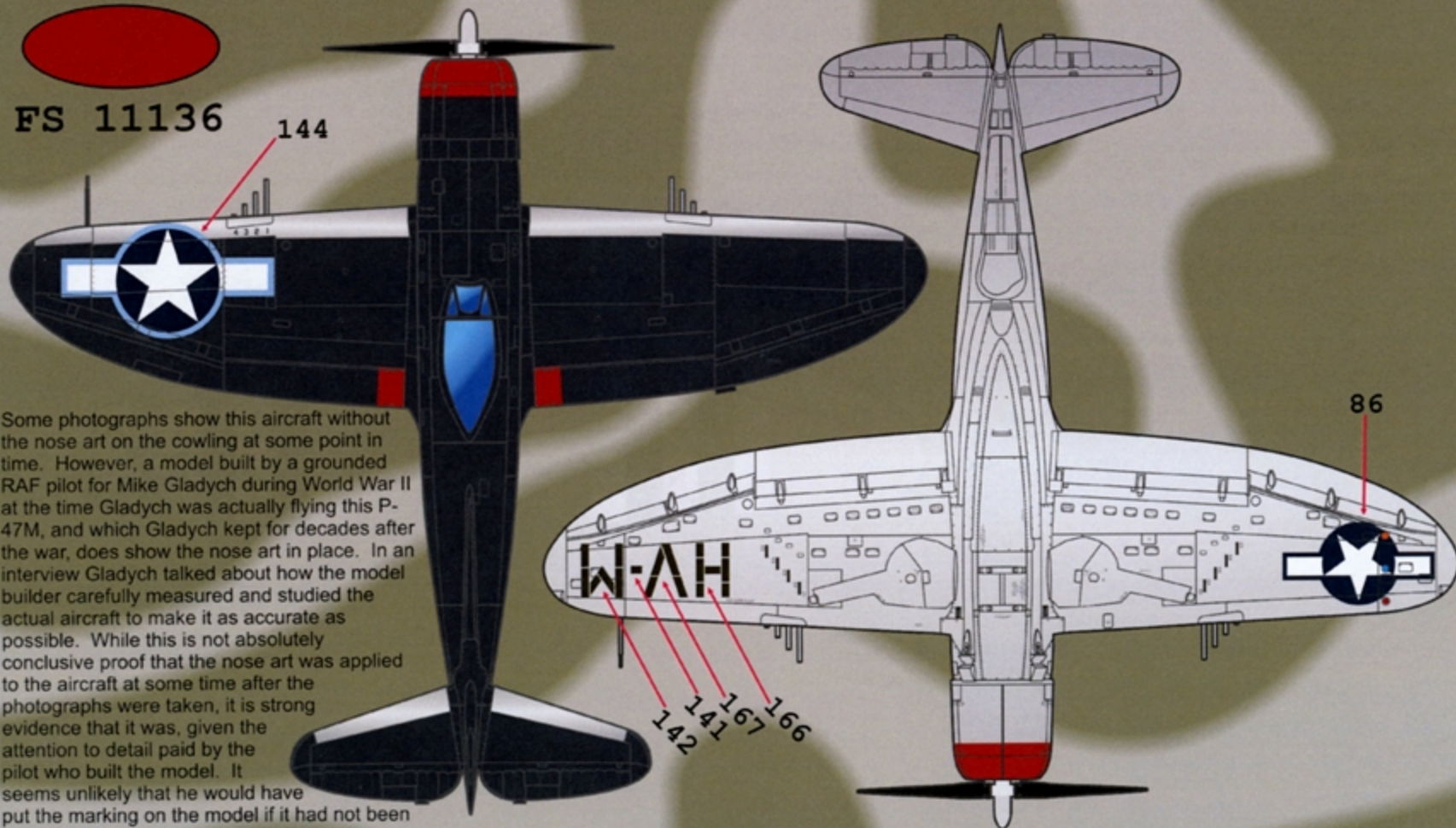

Some photographs show this aircraft without the nose art on the cowling at some point in time. However, a model built by a grounded RAF pilot for Mike Gladych during World War II at the time Gladych was actually flying this P-47M, and which Gladych kept for decades after the war, does show the nose art in place. In an interview Gladych talked about how the model builder carefully measured and studied the actual aircraft to make it as accurate as possible. While this is not absolutely conclusive proof that the nose art was applied to the aircraft at some time after the photographs were taken, it is strong evidence that it was, given the attention to detail paid by the pilot who built the model. It seems unlikely that he would have put the marking on the model if it had not been on the real aircraft. We have included the nose art on the decal sheet, and the modeler can use it or leave it off as desired.

FLAT BLACK WITH A TOUCH OF BLUE  
 NO OFFICIAL DESIGNATION IS KNOWN





P-47D-25-RE 42-26549  
 LT COL. WILLIAM BAILEY  
 352D FTR SQ, 353D FTR GP  
 JULY 1944

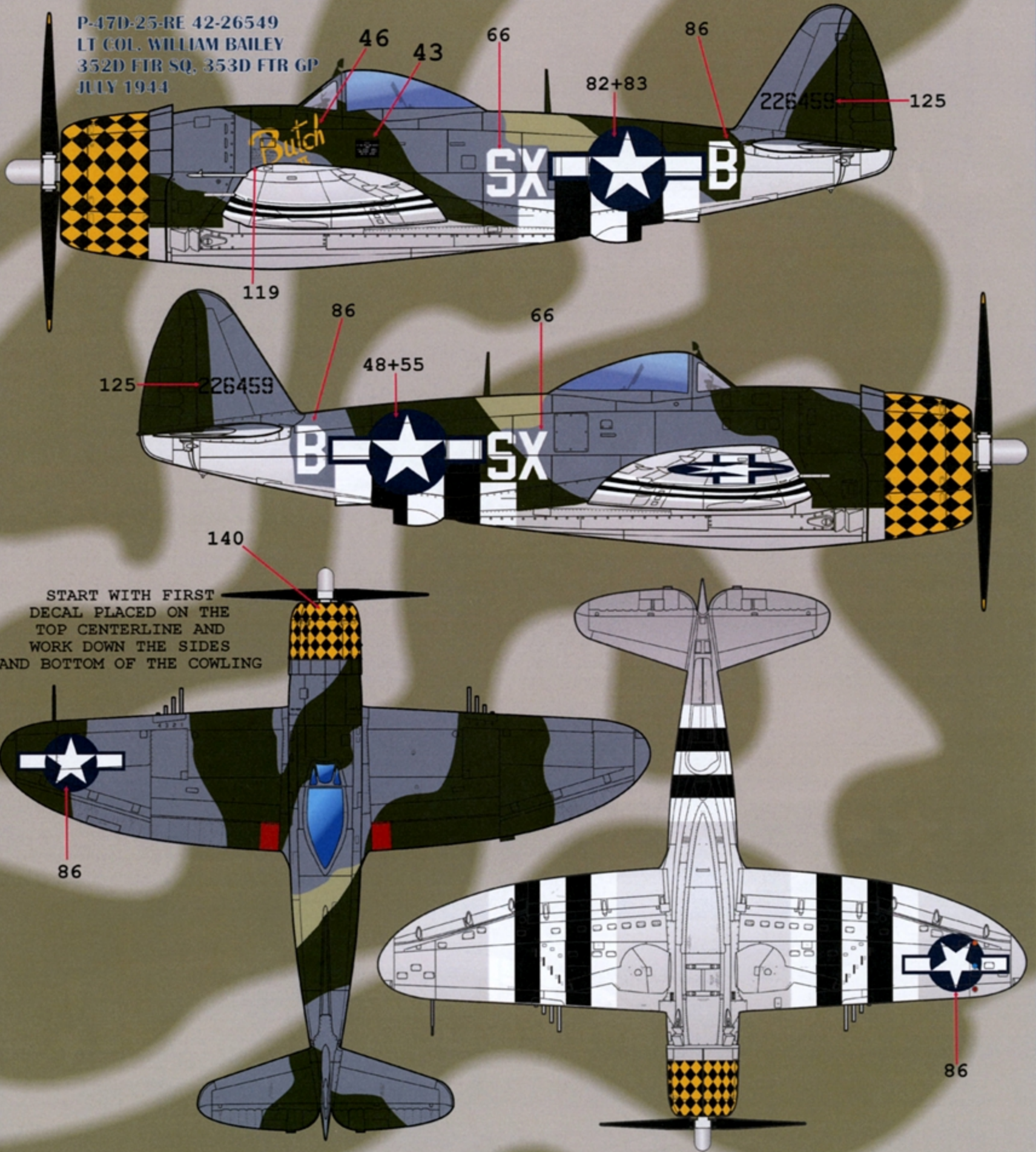

START WITH FIRST  
 DECAL PLACED ON THE  
 TOP CENTERLINE AND  
 WORK DOWN THE SIDES  
 AND BOTTOM OF THE COWLING



FS 36270



FS 34096

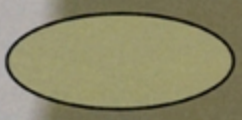

FS 34424



FS 33538



NATURAL  
 METAL



P-47D-22-RE 42-2629S  
 LT. ALBERT KNAFELZ  
 62nd FTR SQ, 56th FTR GP  
 1945

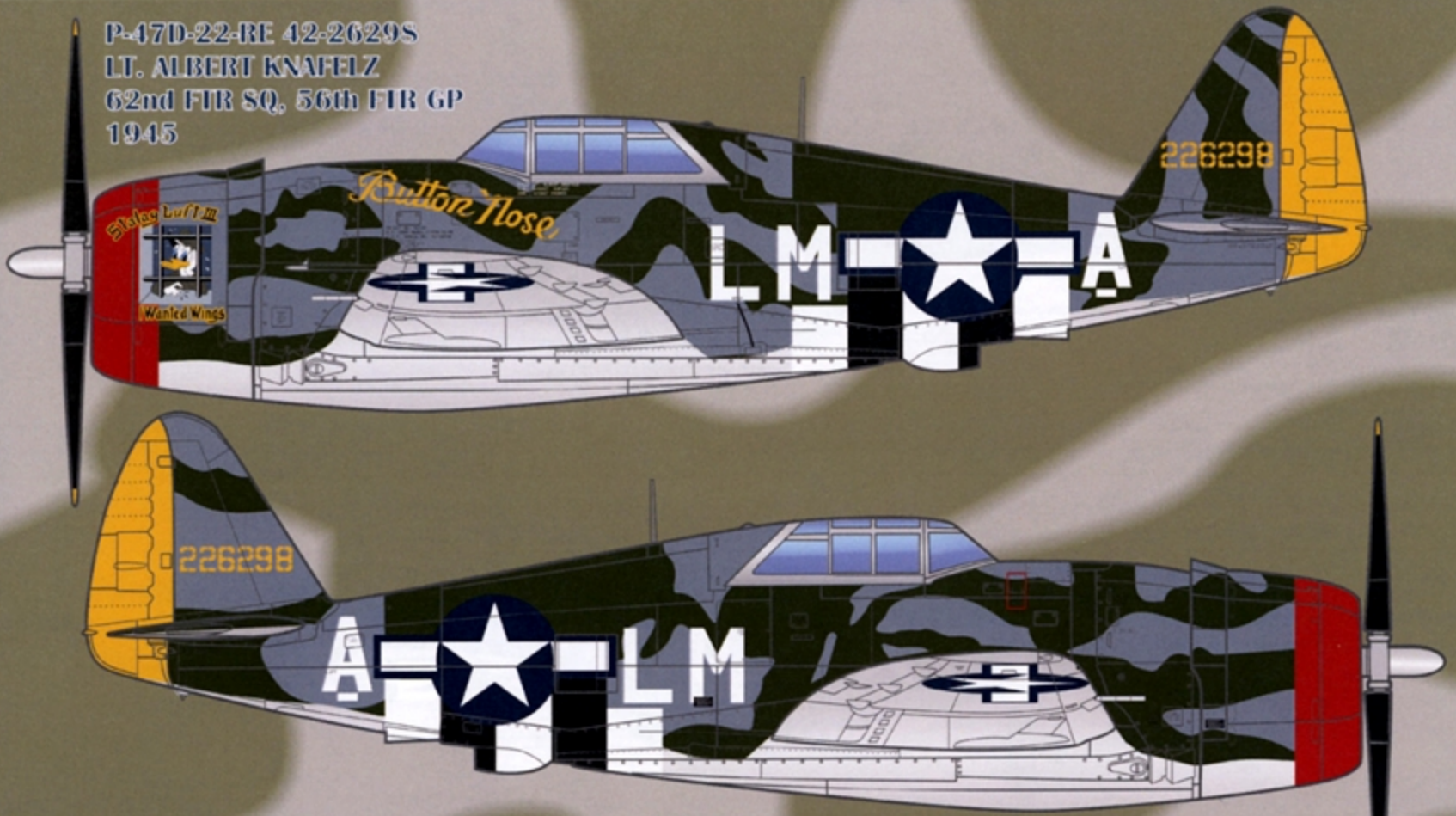

				
FS 36270	FS 34096	FS 11136	FS 33538	NATURAL METAL



P-47M-1-RE 44-21149  
 LT. THOMAS SMITH  
 63d FIR SQ, 56th FIR GP  
 1945

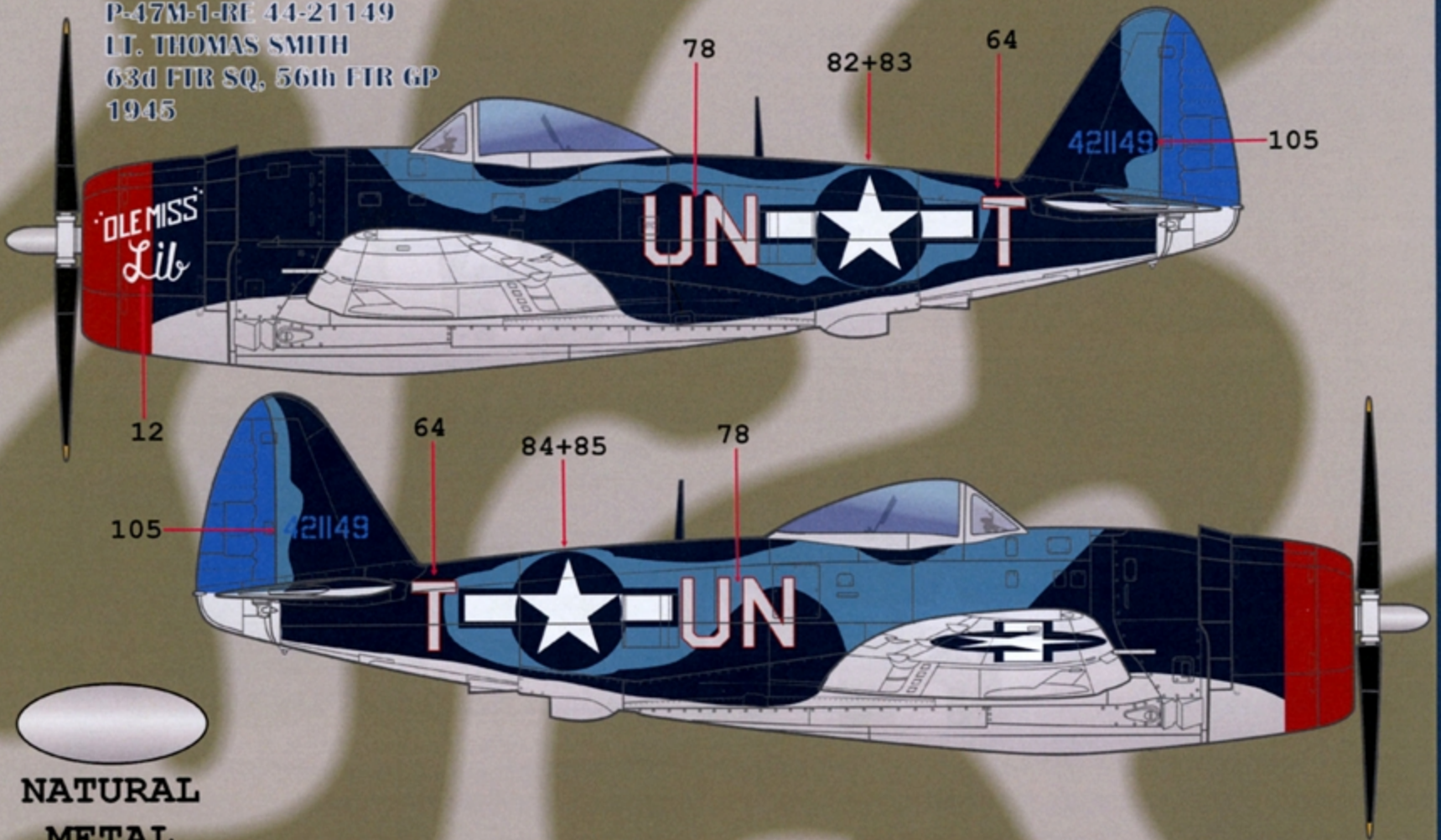

  
 NATURAL  
 METAL

  
 FS 11136

  
 FS 35183

  
 FS 15044

  
 FS 35190

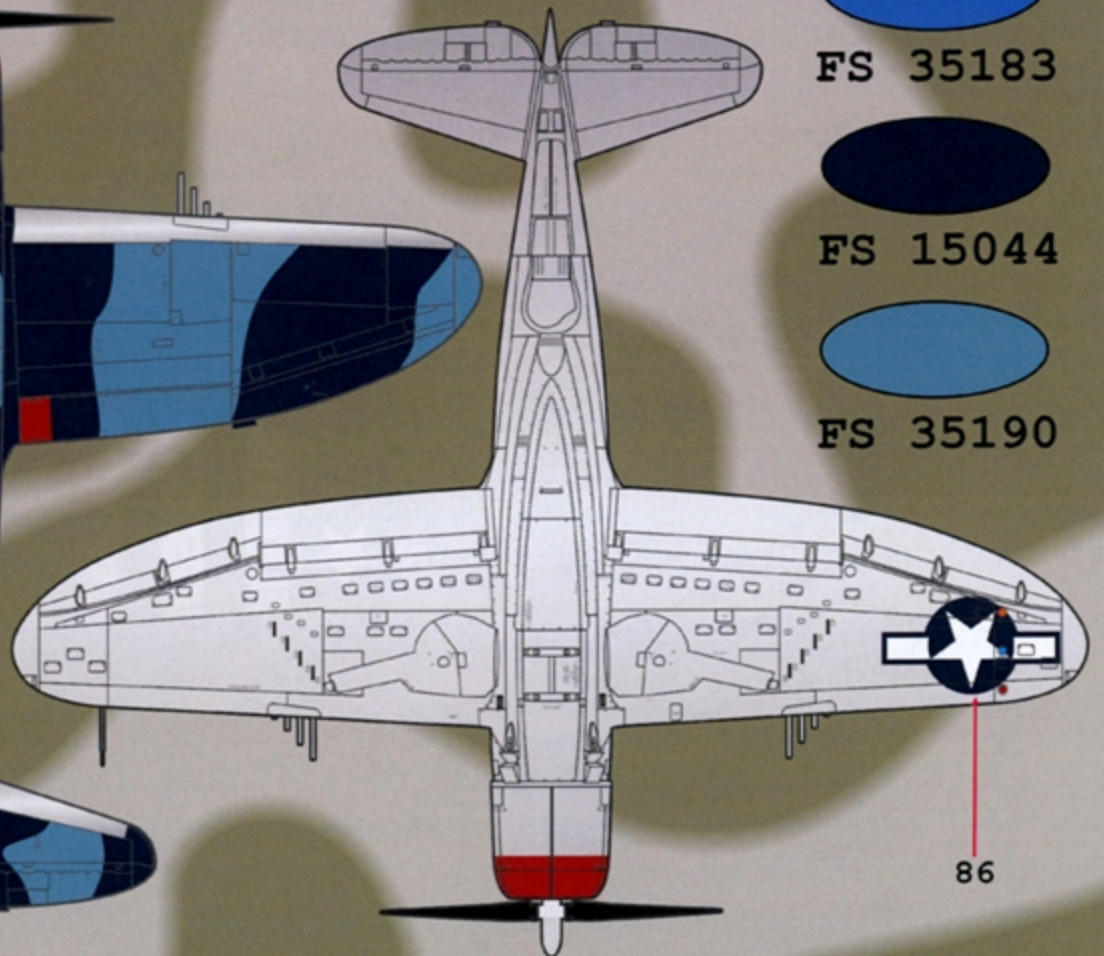
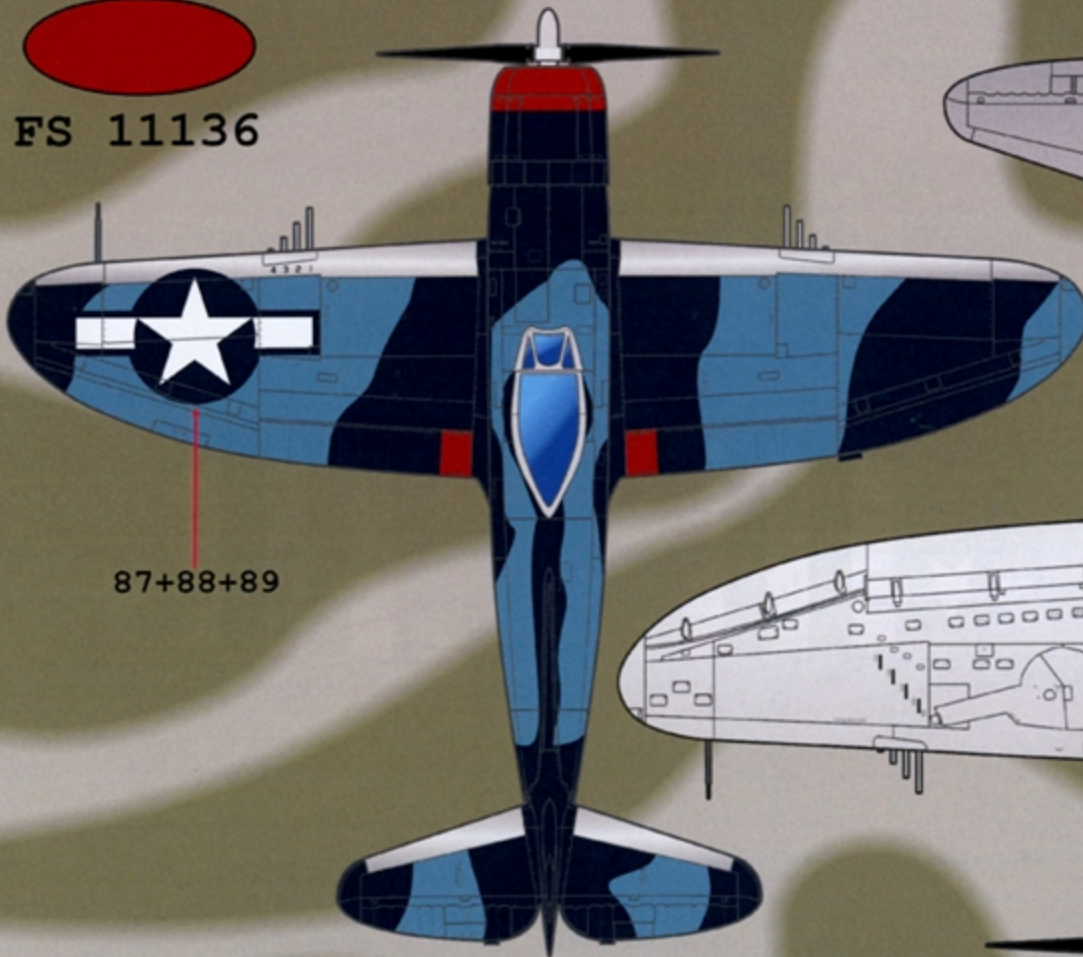

-COLOR PHOTOGRAPHS OF 63RD FS P-47S SHOW THAT THE DARK BLUE EXACTLY MATCHES THE INSIGNIA BLUE OF THE NATIONAL INSIGNIA.  
 -ANECDOTAL EVIDENCE SUGGESTS THAT THE LIGHT BLUE COLOR WAS FS 15044 LIGHTED WITH WHITE. WE BELIEVE FS 35190 IS A CLOSE MATCH.



P-47M-1-RE 44-21199  
 LT. LEO BUTISTE  
 62D FIR SQ, 56th FIR GP  
 1945

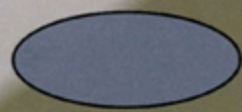
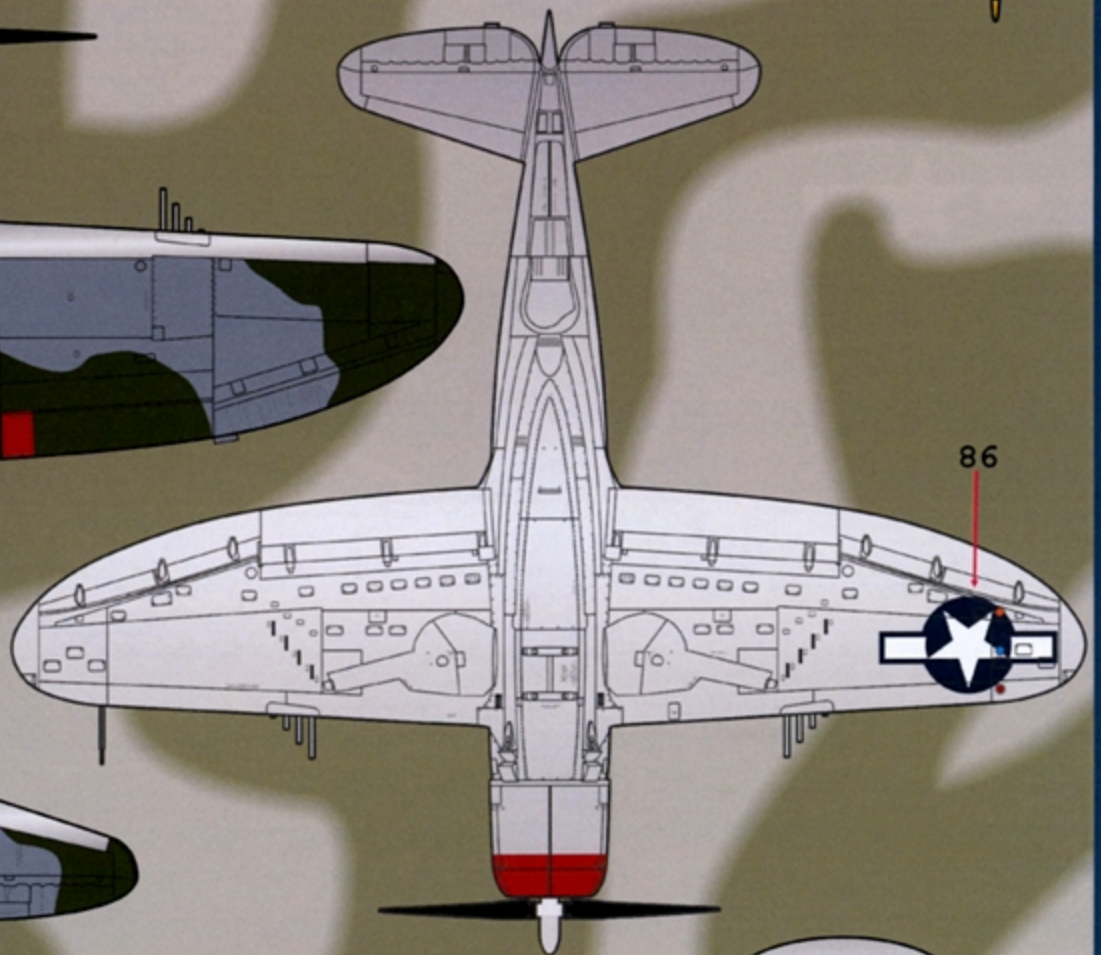
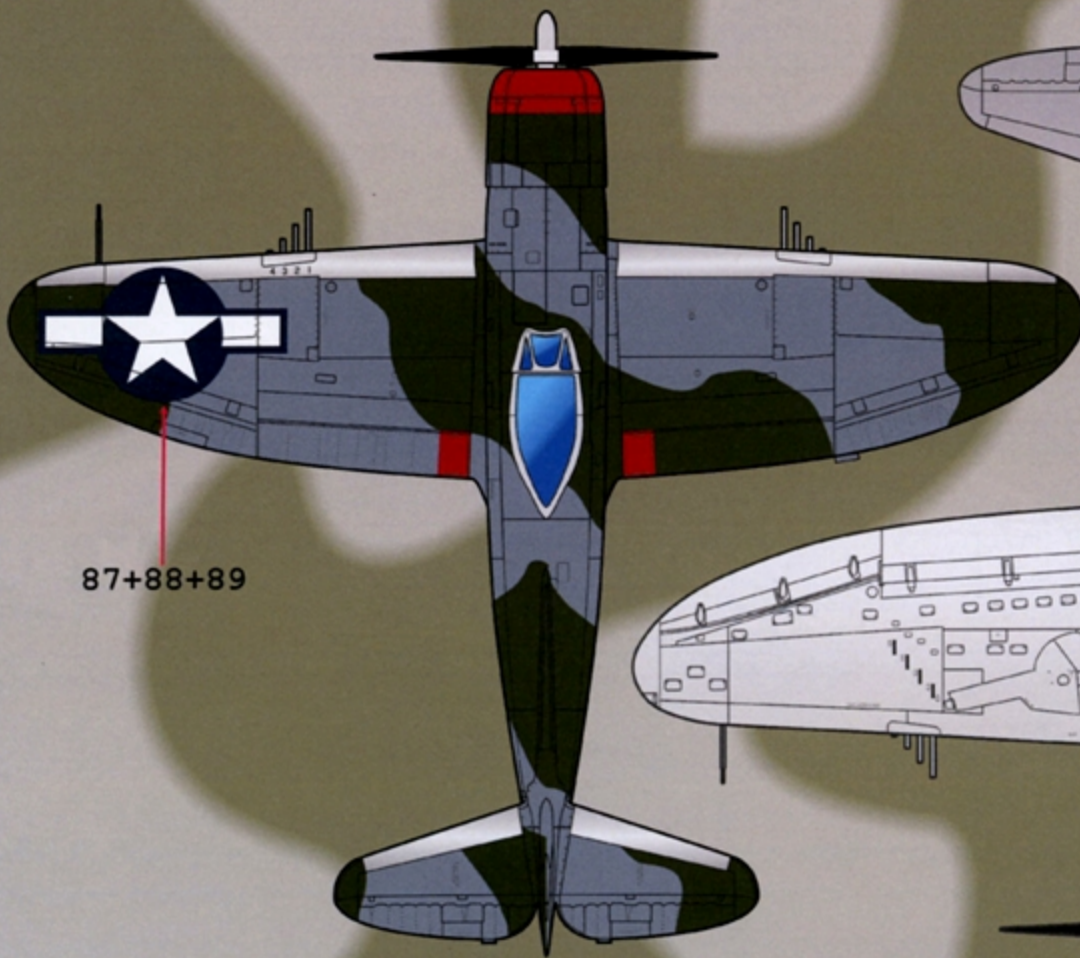
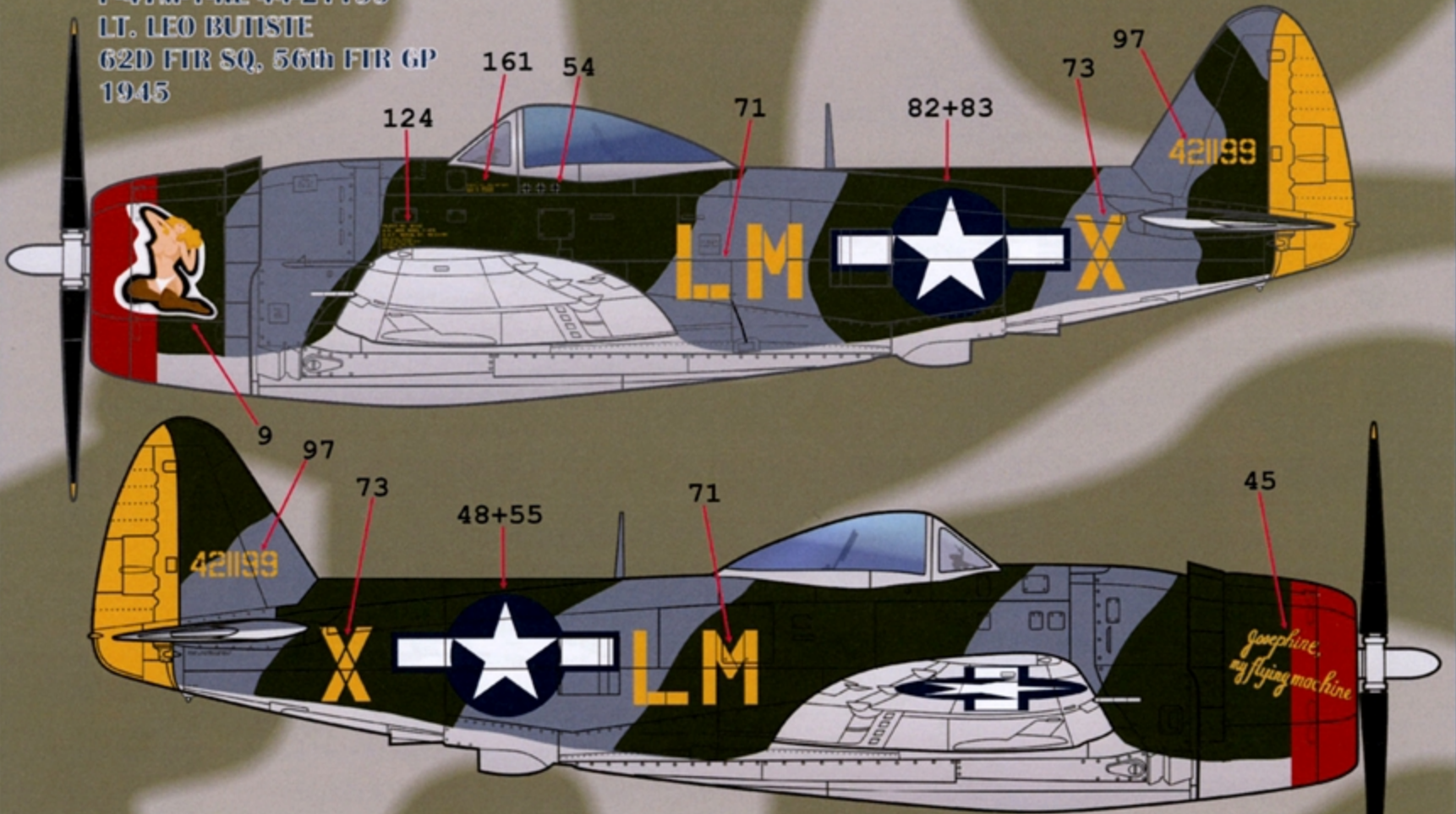

FS 36270



FS 34096



FS 11136



FS 33538



NATURAL  
 METAL



P-47M-1-RE 44-21117  
 MAJ. M.J. JACKSON  
 62D FTR SQ, 56th FTR GP  
 1945

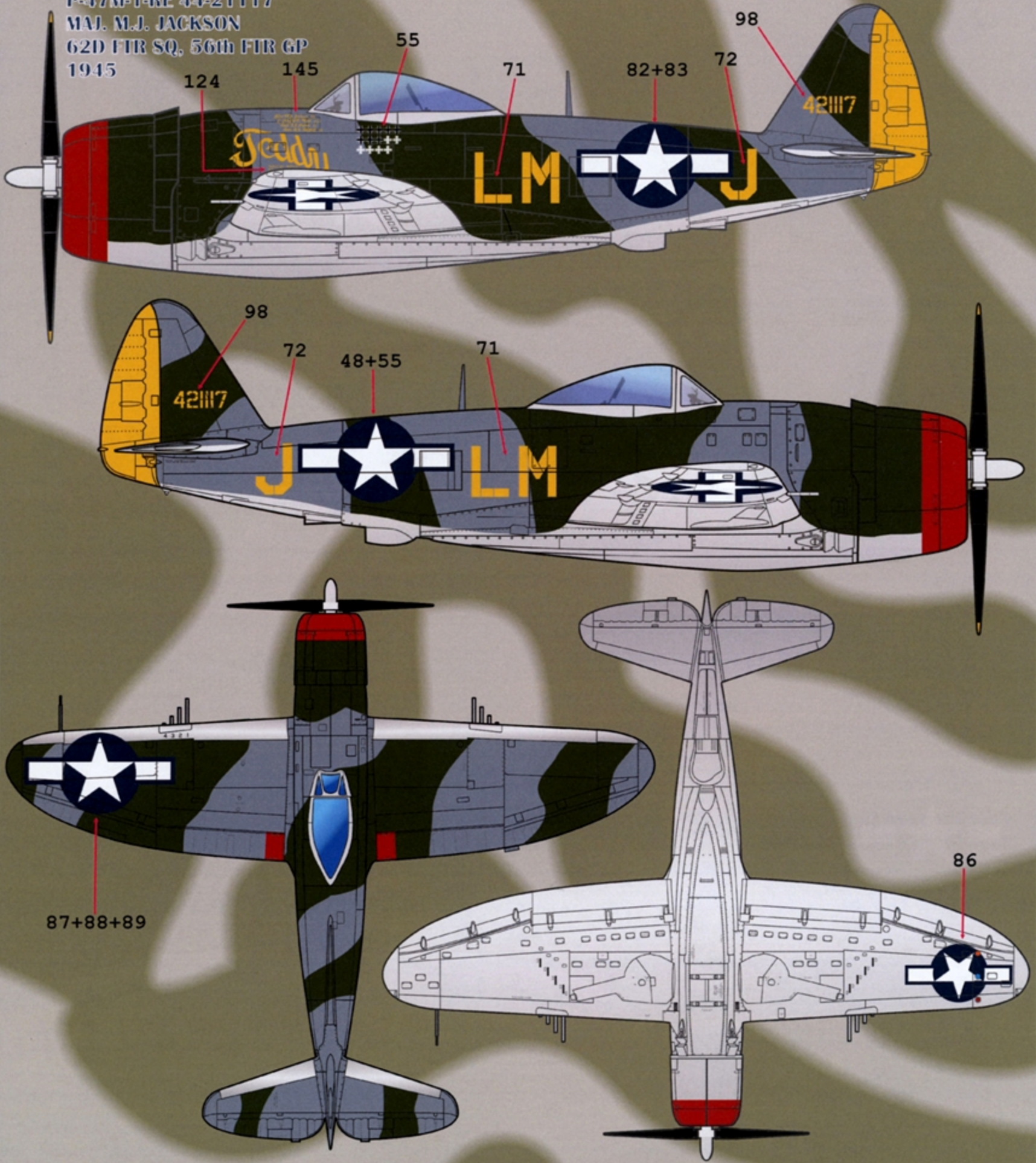

-   
 FS 36270
-   
 FS 34096
-   
 FS 11136
-   
 FS 33538
-   
 NATURAL  
 METAL



P-17D-25-RE 42-26641  
 COL D.C. SCHILLING  
 62D FIR SQ, 56th FIR GP  
 1945

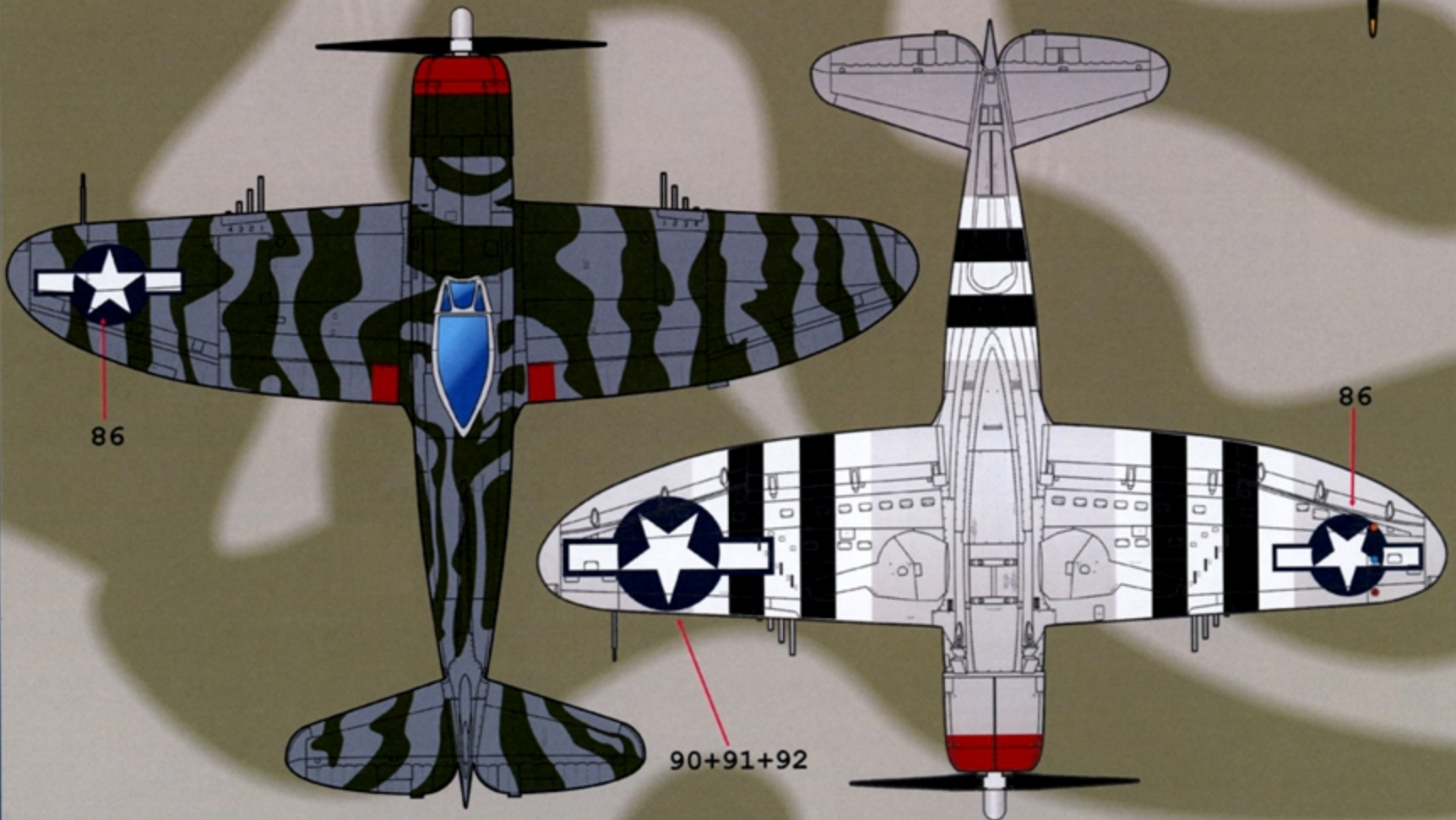
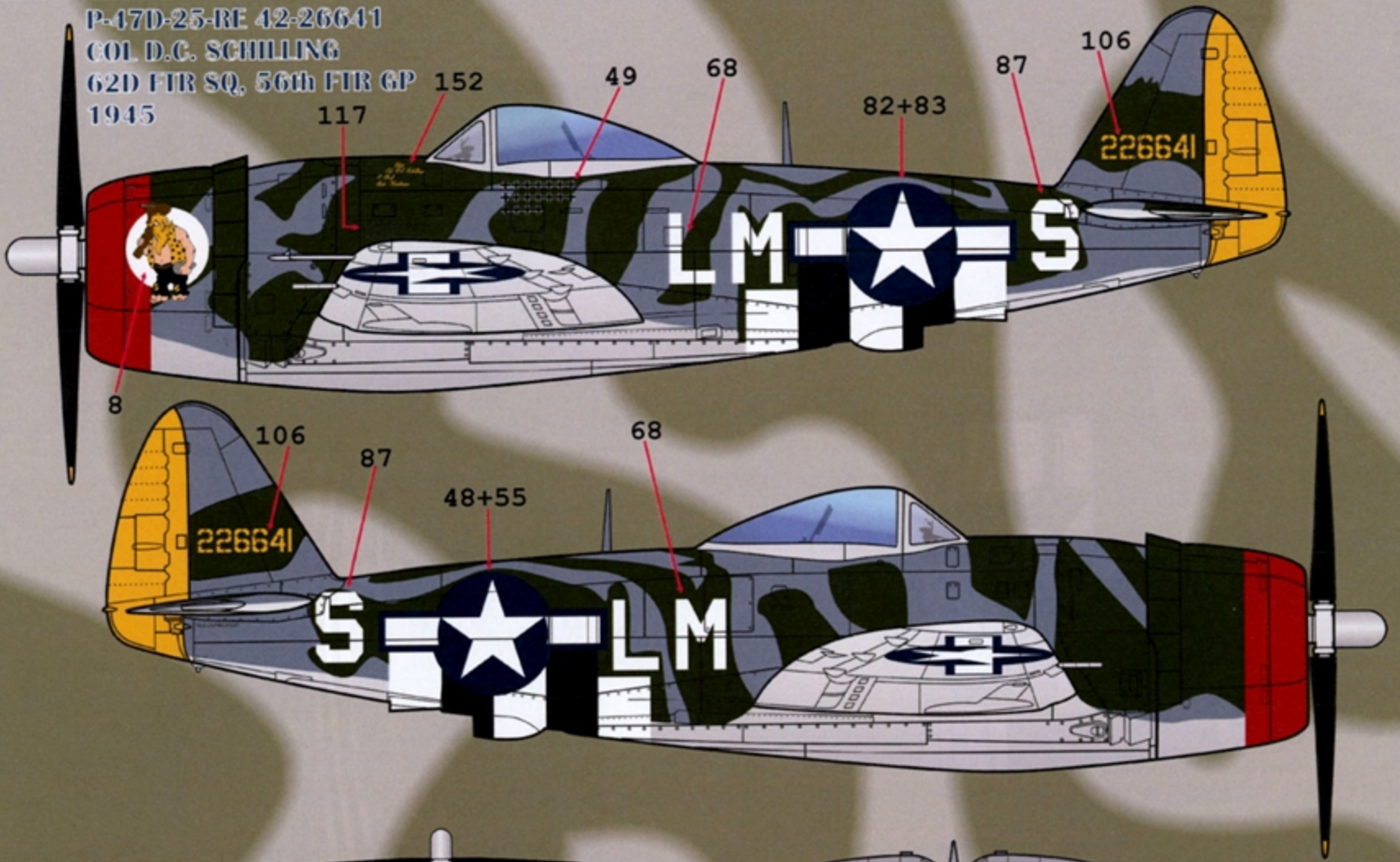



# STENCIL & DATA

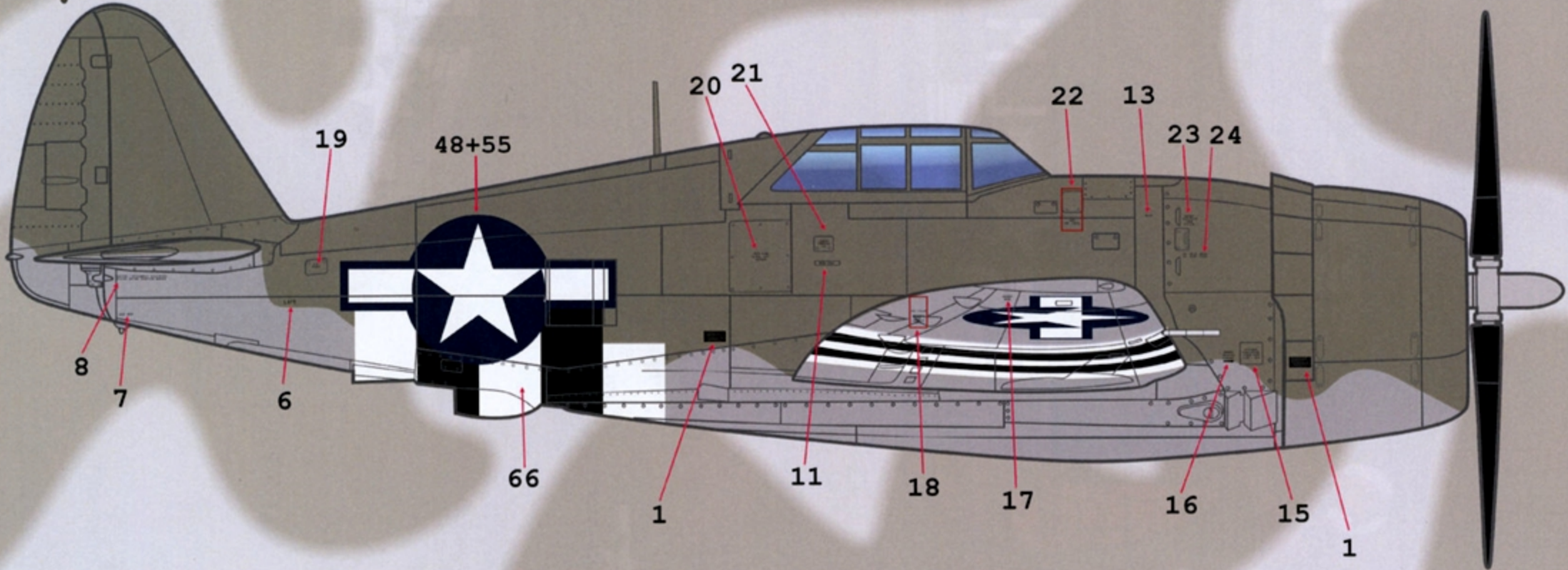
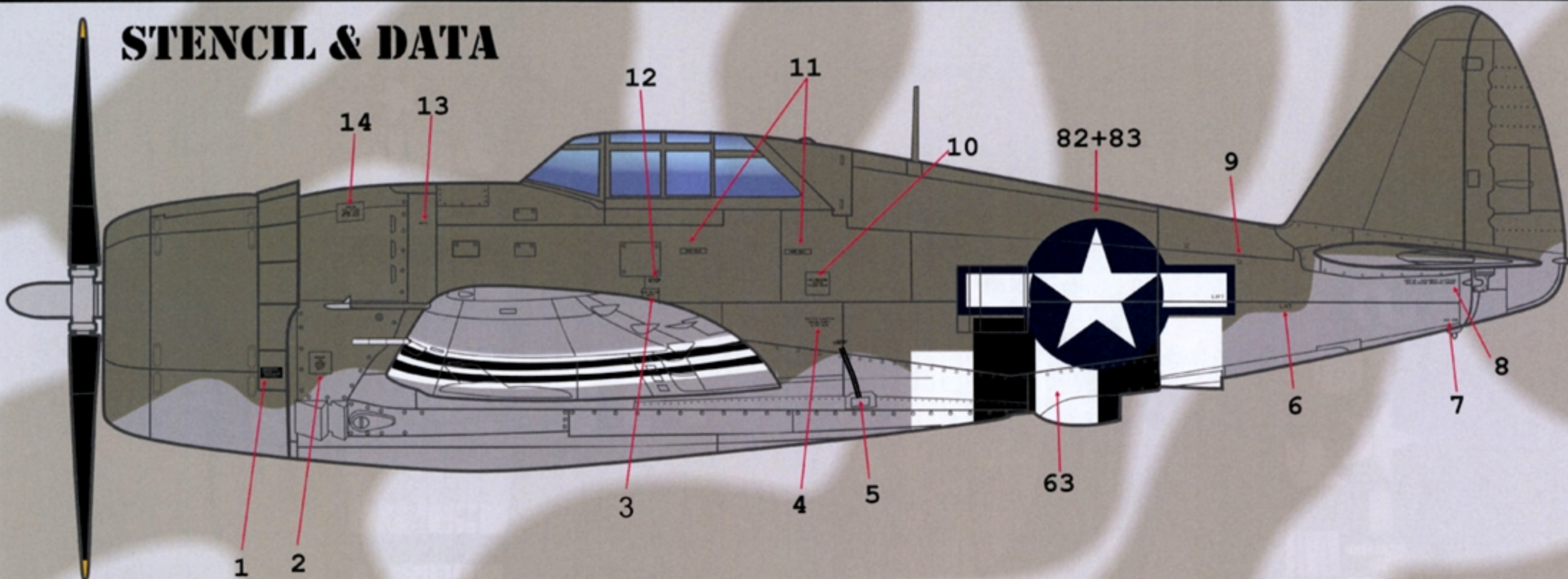



Hey Modelers! Check out the ModelGeeks Scale Modeling Podcast, a place where 5 Navy vets talk about anything and everything relating to models. Buckle up for an exciting and entertaining Journey into the world of scale modeling.



[www.modelgeekspodcast.com/](http://www.modelgeekspodcast.com/)

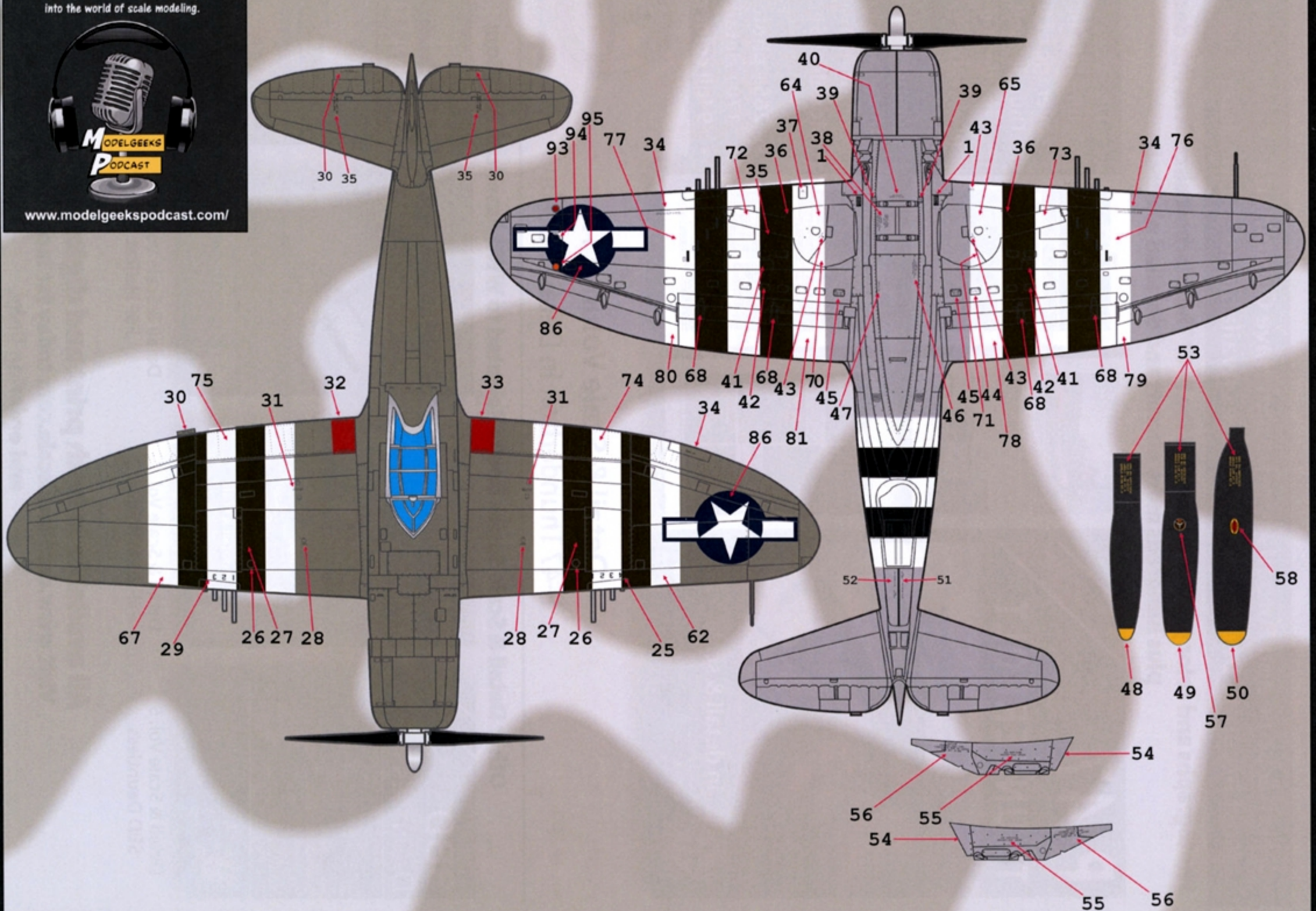

© 2010 Danvers  
 Scale Modeling Podcast  
 www.modelgeekspodcast.com