

# HKP 4A, B, C & D Vertol

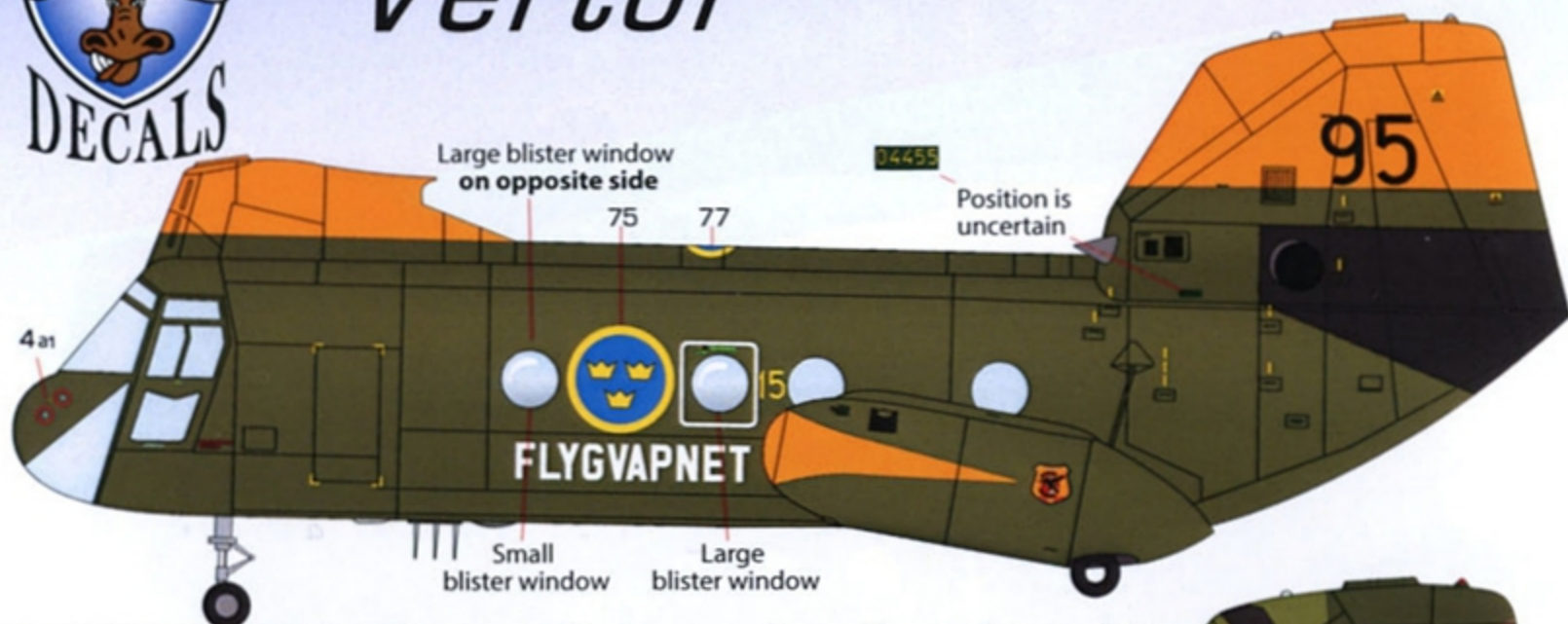

**04455, HKP 4A, O95 - F15 Söderhamn.** Modern type of stencils according to "b" on decal sheet.

Airframe painted olive green 325.



**04074, HKP 4D, Y74 - 13 Hkp div Kallinge/Ronneby.** This is one of the modified HKP 4A, earlier 04455 in the Airforce.

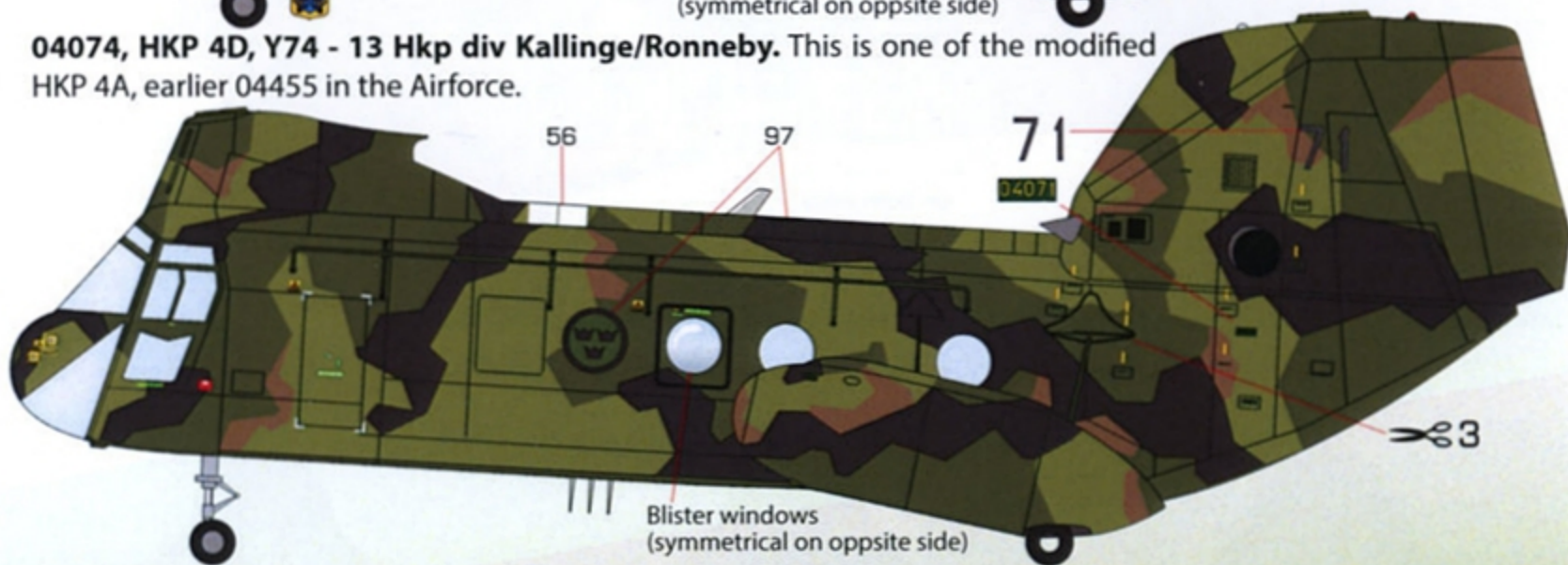

**04071, HKP 4C, Y71 - 2 Hkp div Kallinge/Ronneby 2008.** Together with Y65, Y68 and Y70 this helicopter was modified with machine guns m/58 (and mounts) in the aft and the forward left & right positions to be a part of foregin peacekeeping operation "Nordic Battlegroup '08". Note that the forward left (emergency) panel around the window was removed and covered with a panel on these a/c when the gun was detached.

(Blister window on opposite side.)

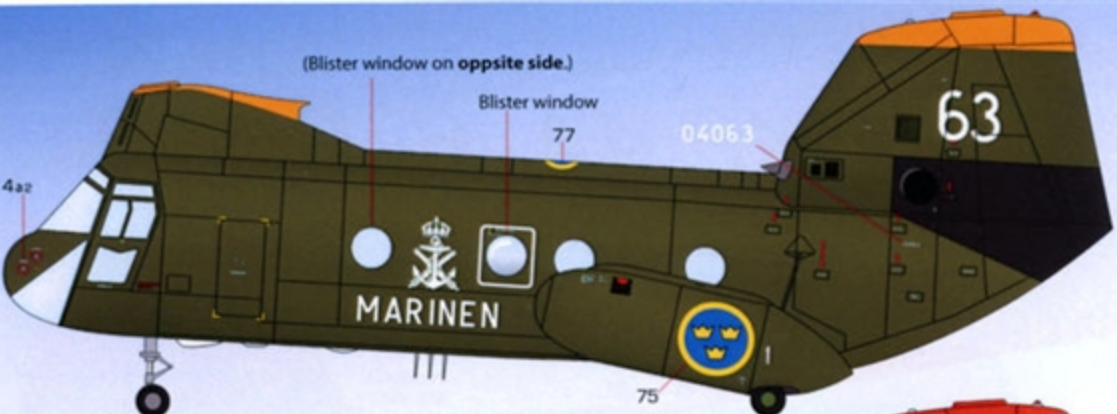

**04063, HKP 4B, Y63 - Berga.** Early stencils according to "a" on decal sheet and painted in Olive green 325. Note that later HKP 4C has another spacing between the letters in "MARINEN".



**04061, HKP 4B, Y61 - Berga.** Early stencils and painted in Olive green 325, see bottom side view for more details.

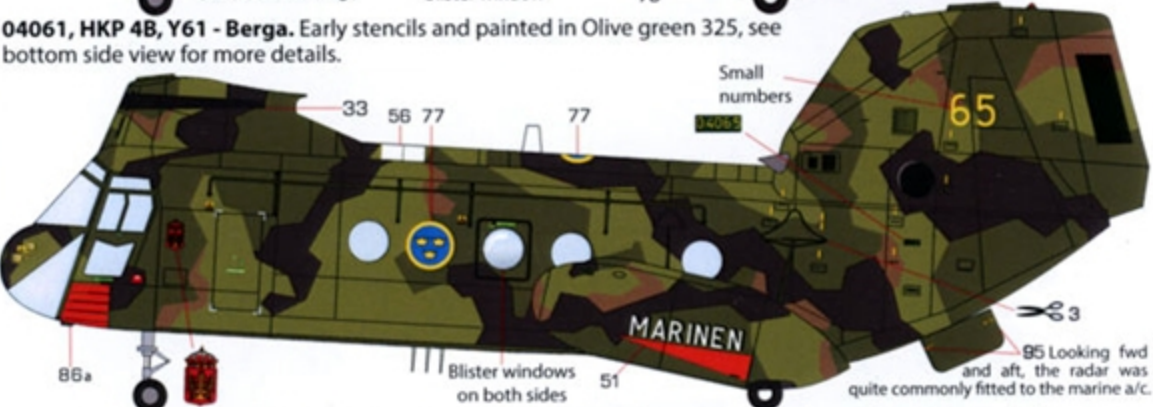

**04065, HKP 4C, Y65 - 11 Hkp div Berga.** This is the standard submarine hunter livery from 1980 to the beginning of 2000. This was one of the first rescue helicopters at the Estonia accident site on the 28th september 1994. It was later nicknamed "Gordon". Late type of stenciling and camouflage painted rotor blades.

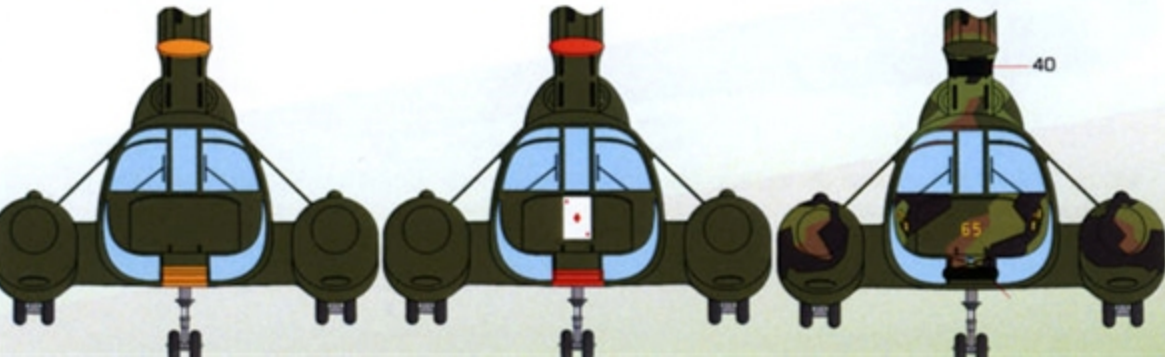

All markings are symmetrical where nothing else is stated (stencils excluded).

Placed/read upside down.

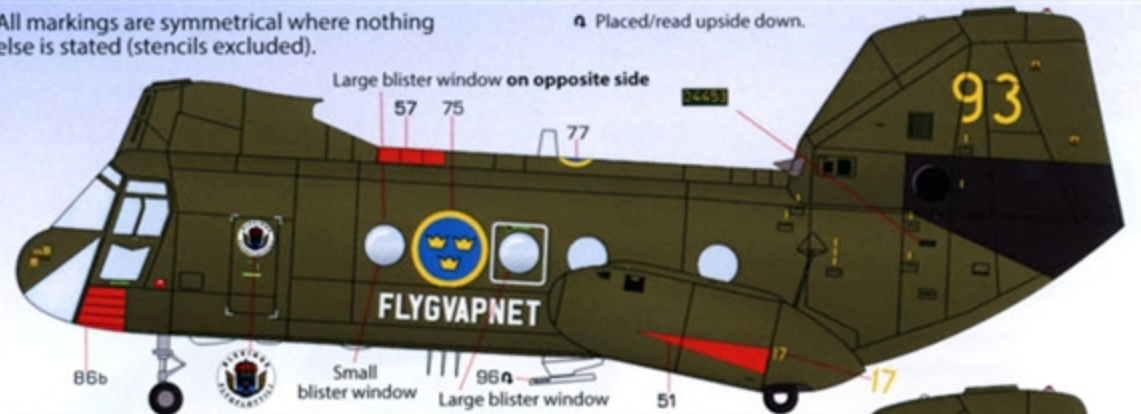

**04453, HKP 4A, Q93 - F17 Kallinge/Ronneby.** Camouflage painted rotor blades and use the later stenciling ("b").



**04451, HKP 4A, U91 - F21 Kallax/Luleå.** Painted in Olive green 325, camouflage painted rotor blades and later stenciling ("b").



**04453, HKP 4D, Q93 - F17 Kallinge/Ronneby.** In order to fill the gap before the transition to HKP 10 Puma, two D-models were used at F17 (the other one was Q98) before they were transferred to the Marine in 1991. D was an upgrade to the old airframes with short empennage to meet the HKP4C std. The D modification included stronger engines, light weight rotor blades and autopilot. Camouflage painted rotor blades and later stenciling ("b").



# HKP 4A, B, C & D Vertol

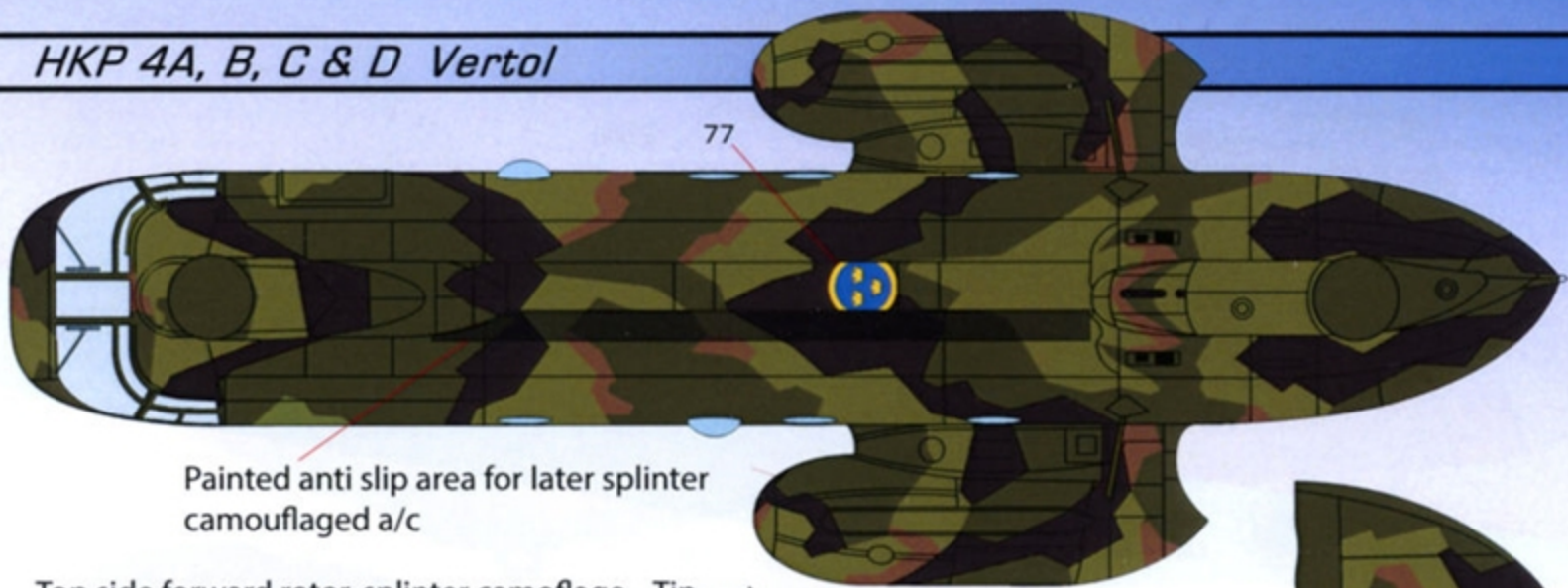

Painted anti slip area for later splinter camouflaged a/c

Top side forward rotor, splinter camouflage. Tip →

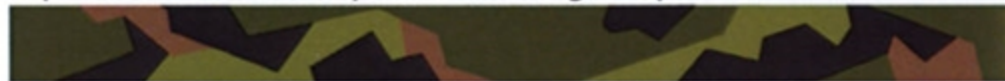

Top side aft rotor, splinter camouflage. Tip →

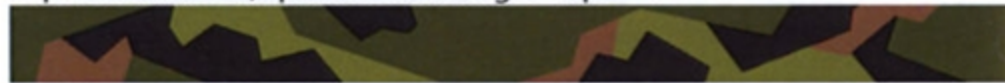

Top side forward and aft rotor, early paint scheme unidentified glossy grey. Tip ↙

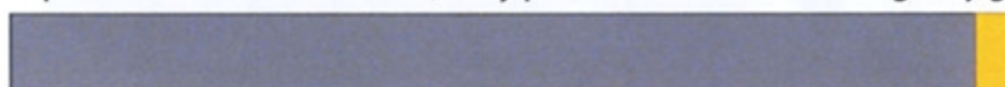

Bottom side forward and aft rotor, glossy black probably analogous over the entire service time. Tip →

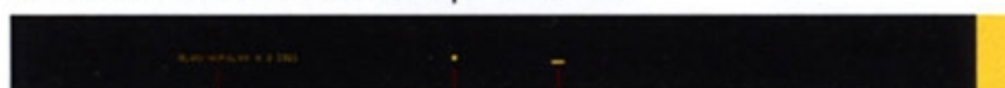

78 (Fwd)  
79 (Aft)

94

93



**Mid Green 322**

Close FS number:

34138 /34187

Mr. Paint: MRP 178

Hataki: HTK- A325



**Dark Green 326**

Close FS number:

34092 /34128 /34079

Mr. Paint: MRP 177

Hataki: HTK- A324



**Black 093**

Black/Antrazit

Mr. Paint: MRP 176



**Brown 507**

Close FS number:  
30117 /30219 /30051

Mr. Paint: MRP 179

Hataki: HTK-A160

Decals 92 is intended to be used for the individual rotor blade markings (yellow, red and green band on each blade).



04069, HKP 4C, Y69 - 12 Hkp div Säve. This aircraft was also involve din the rescue mission of Estonia



04465, HKP 4A, O95 F15 Söderhamn.

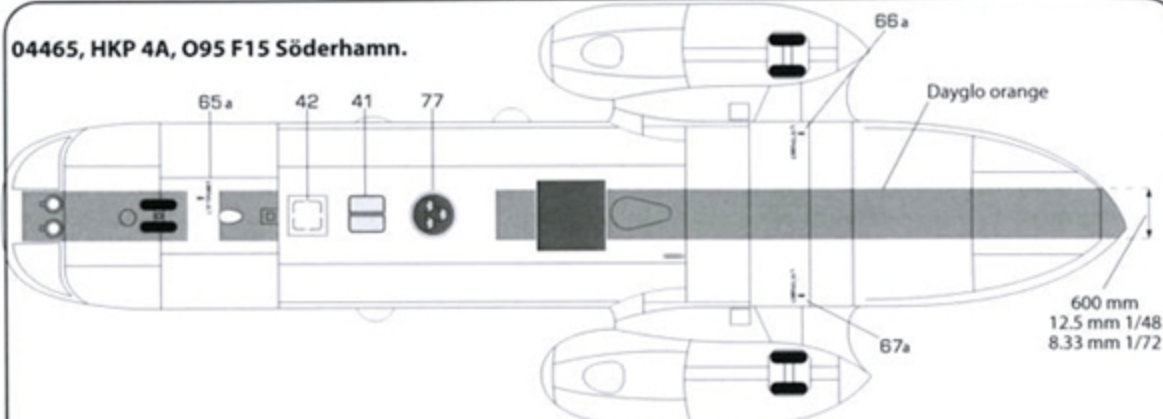

04074, HKP 4B, Y74 Berga. Postions exclusively for this a/c is marked ⊕ in this sketch.  
04069, HKP 4C, Y69 Säve. Postions exclusively for this a/c is marked ⊙ in this sketch (also dashed).

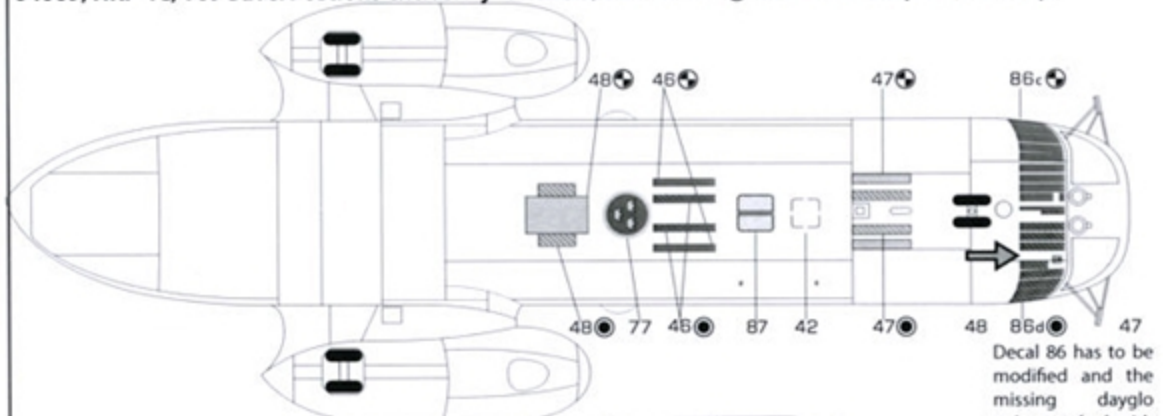

Decal 86 has to be modified and the missing dayglo strip marked with an arrow has to be cut.

04071, HKP 4C, Y71 - 2 Hkp div Kallinge/Ronneby 2008.

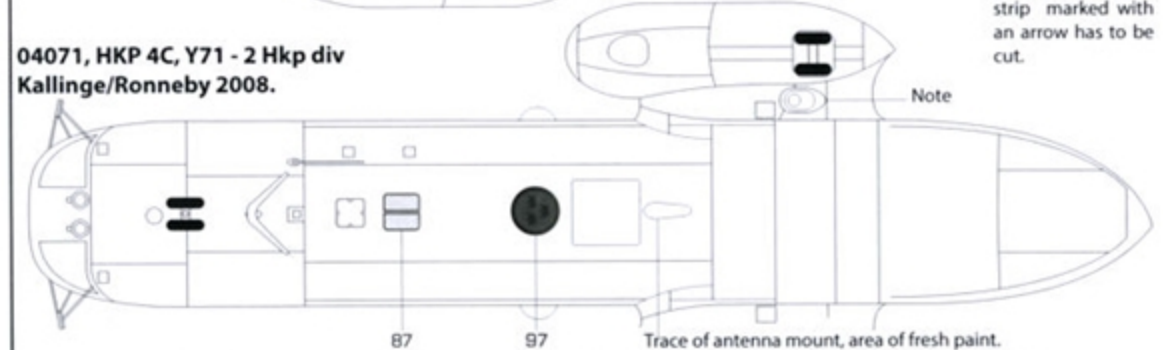

04455, HKP 4A, F15- O95

04065, HKP 4D, Y74

04071, HKP 4C, Y71



04453, HKP 4A, Q93 Kallinge/Ronneby.

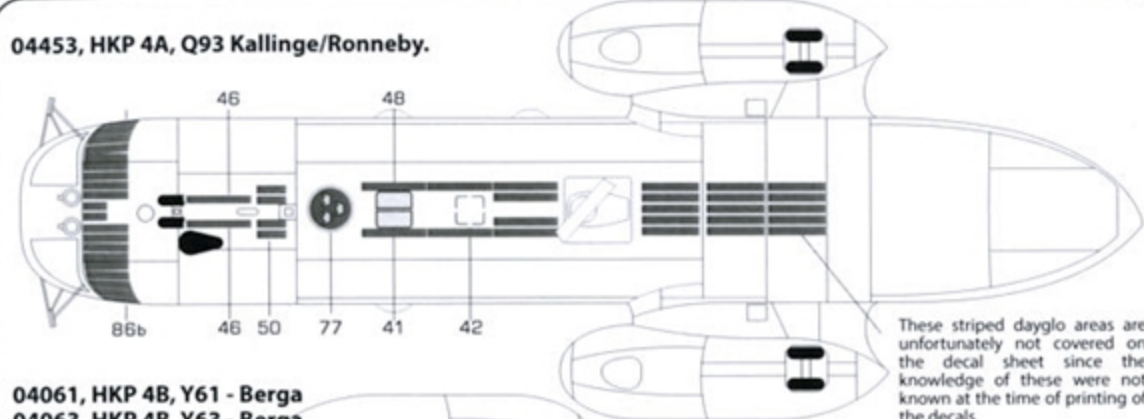

These striped dayglo areas are unfortunately not covered on the decal sheet since the knowledge of these were not known at the time of printing of the decals.

04061, HKP 4B, Y61 - Berga  
04063, HKP 4B, Y63 - Berga

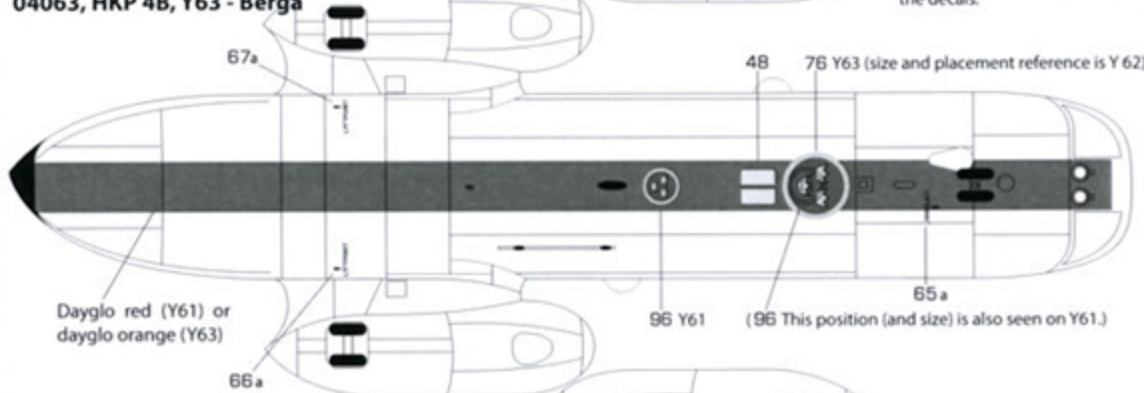

04451, HKP 4A, U91 Kallax/Luleå.

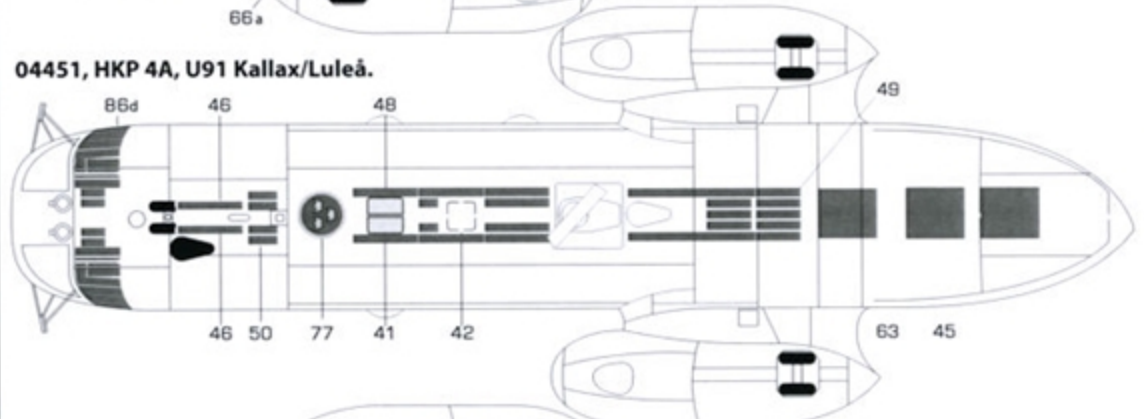

04069, HKP 4C, Y69 - 12 Hkp div Säve.

