

1:72 SCALE

F-84E ThunderJet



EASY ASSEMBLY AUTHENTIC KIT



cyanoacrylate glue
强力胶



weight
配重



make hole
钻孔



cut / remove
切除



option
选择



no cement
不涂胶水



decal
贴纸



bend
弯曲

How to apply the decals

1. Cut off the decal from the decal paper and put it into the warm water 40? for 10 seconds.
2. Take the decal from the water and put it on a piece of clean cloth.
3. Remove the decal slowly from the paper to the targeted location by a wet finger.
4. Use a piece of dry and soft cloth to press it gently on the decal until it getting dry and no bubble existing.

水贴纸的使用方法:

- 一. 把相关的印花从水贴纸上剪下, 放入40°C左右的温水中浸10秒。
- 二. 然后将印花放在干净的布上。
- 三. 拿上印花纸, 手指蘸水将印花移到适当的位置。
- 四. 用软干布轻压印花直至水干, 气泡消失。

F-84E "SANDY" assigned to the 9th FBS, 49th FBW, Base at Taegu, during 1951.

F-84E Which Flown by The CO of the 86th FBW, Col Laven. Germany 1951.

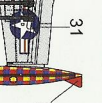
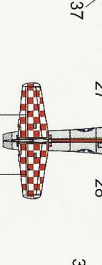
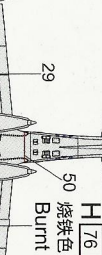
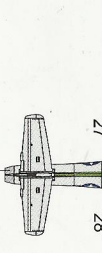
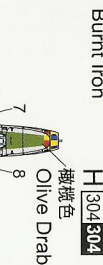
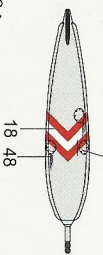
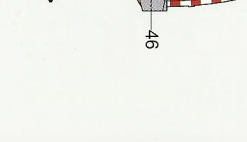
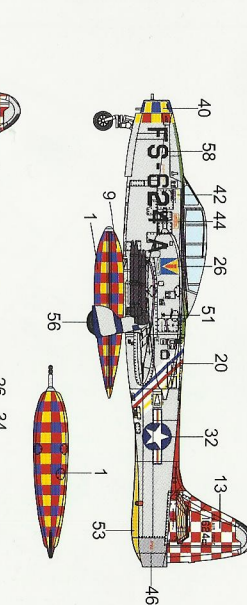
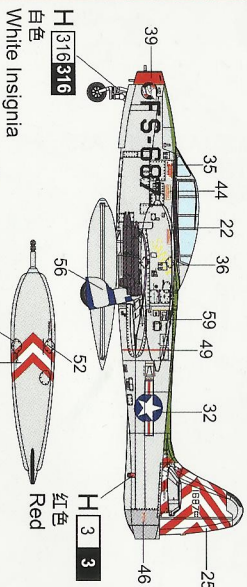

涂装同标贴指示
Painting & Marking guide

涂装同标贴指示
Painting & Marking guide

使用Mr.HOBBY涂料
Mr. Color used

8 AQUEOUS HOBBY COLOUR

8 MR.COLOUR

*Some paints may not be available in your country. Please check your local hobby shop for substitute

部品图 PARTS

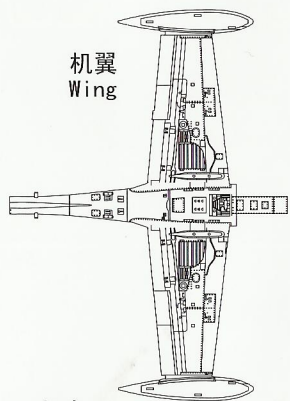
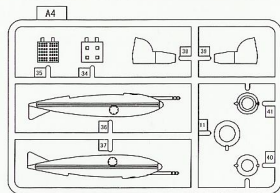
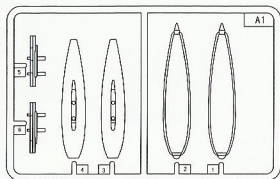
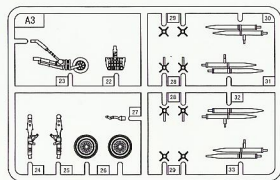
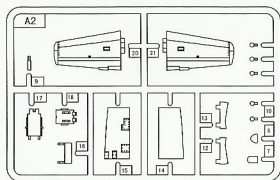

机翼
Wing

机身
Fuselage

不用的部件: A34 A41
Unused parts

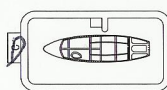

水贴
Decal



1

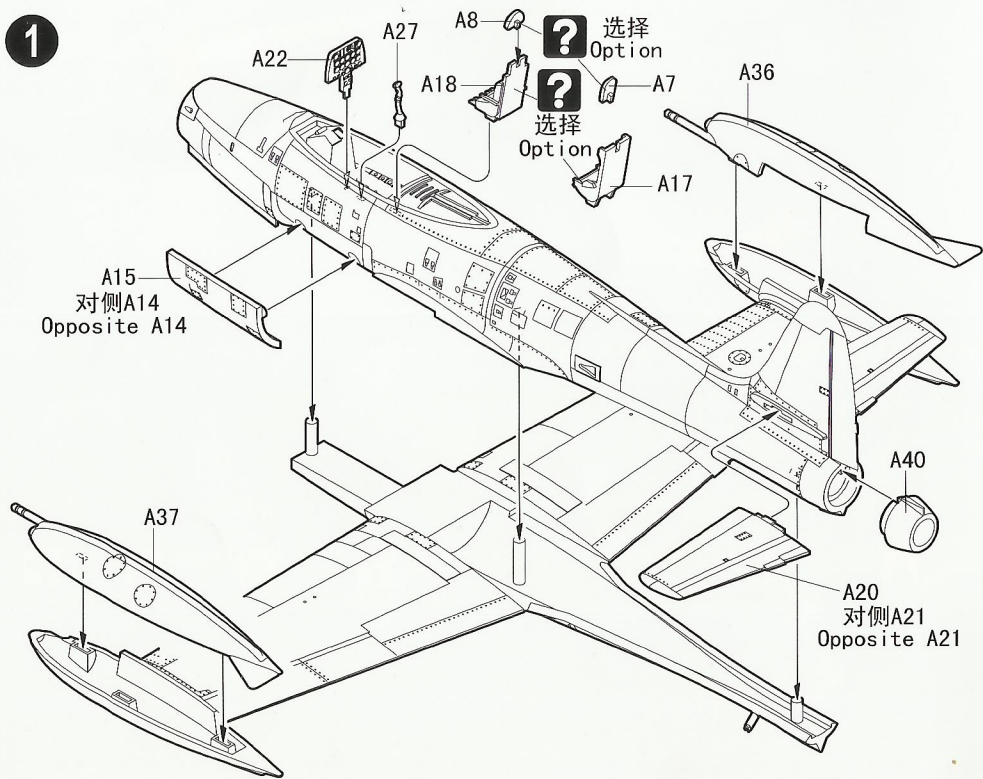

2

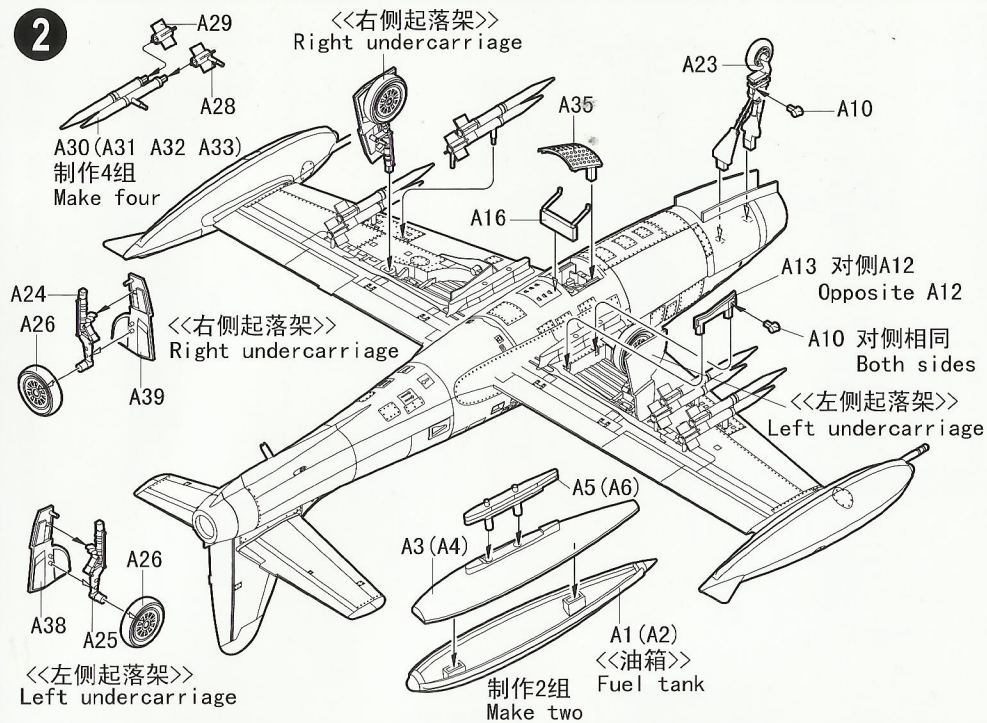

3

