

HIMM

1/72 SCALE
L7208

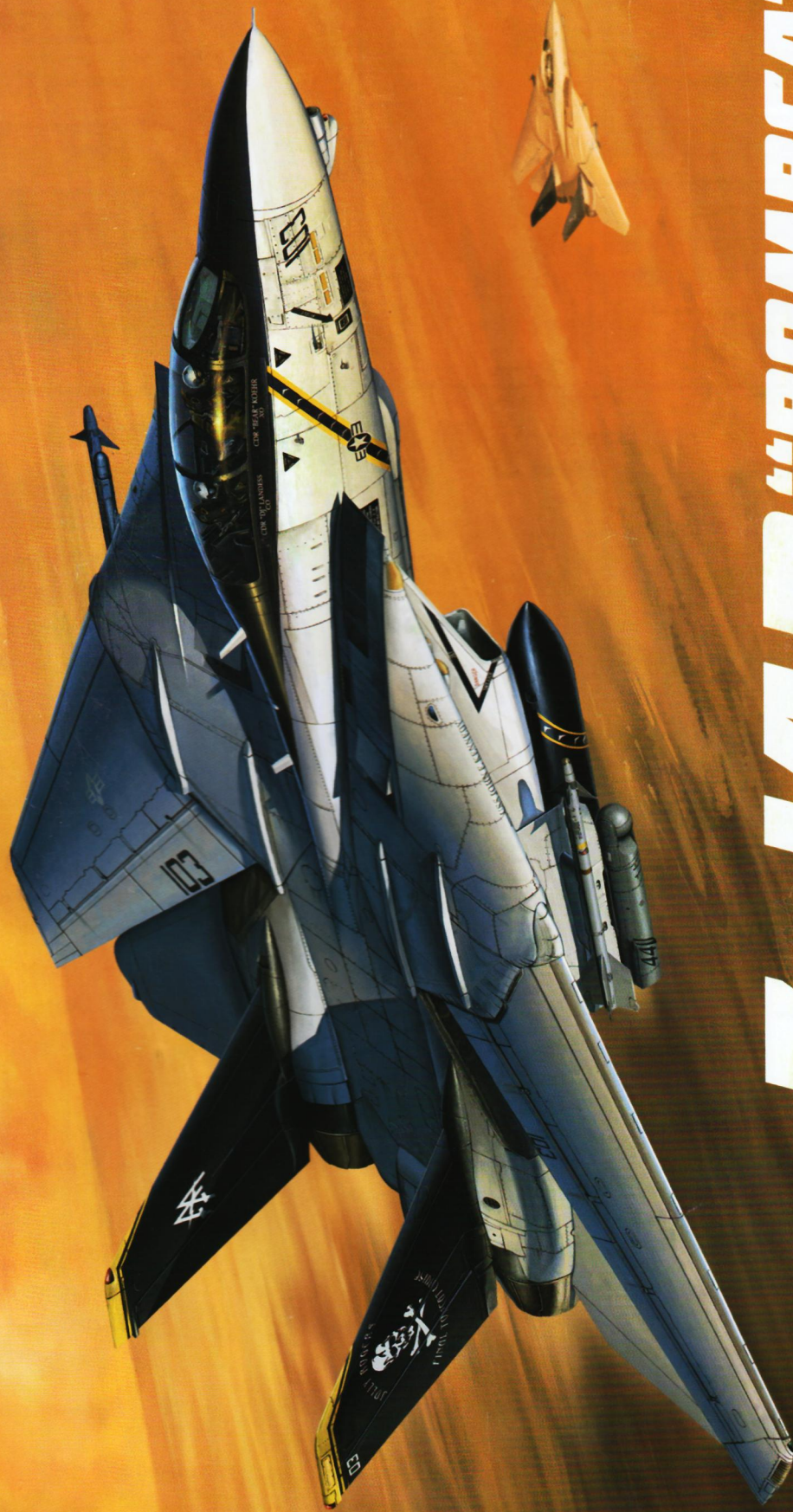

F-14B "BOMBCAT"

F-14B "炸弹猫" 舰载战斗机

1

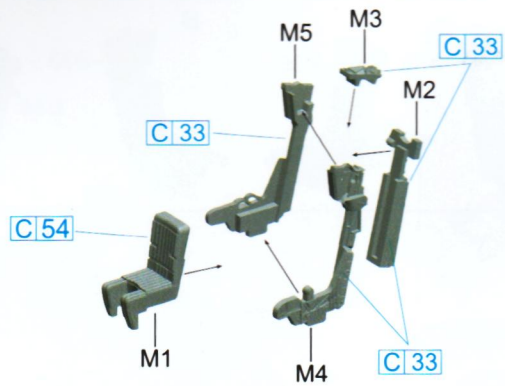

x2

2

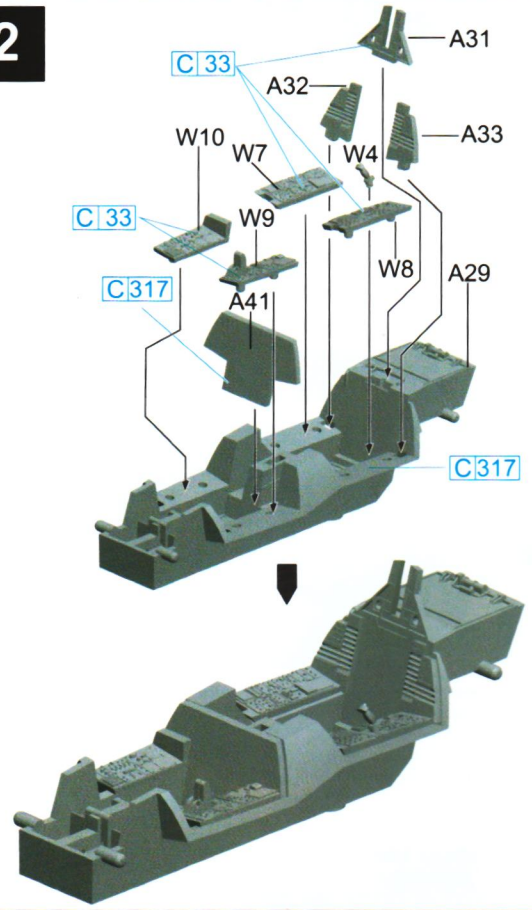

3

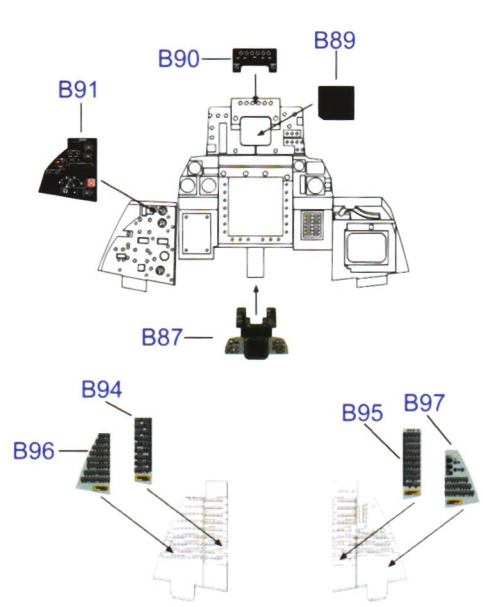
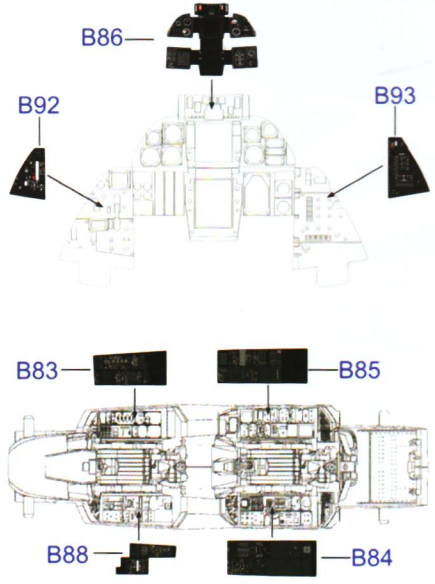
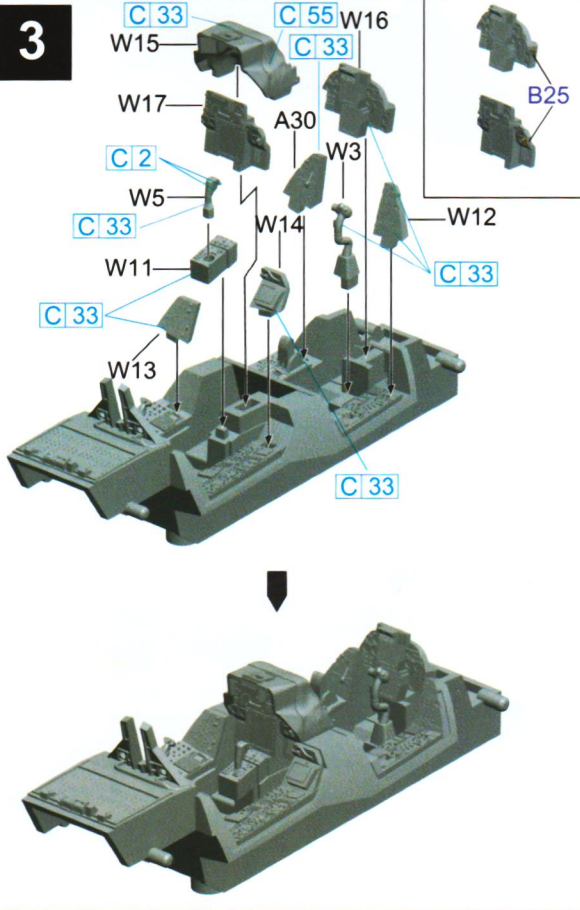

4

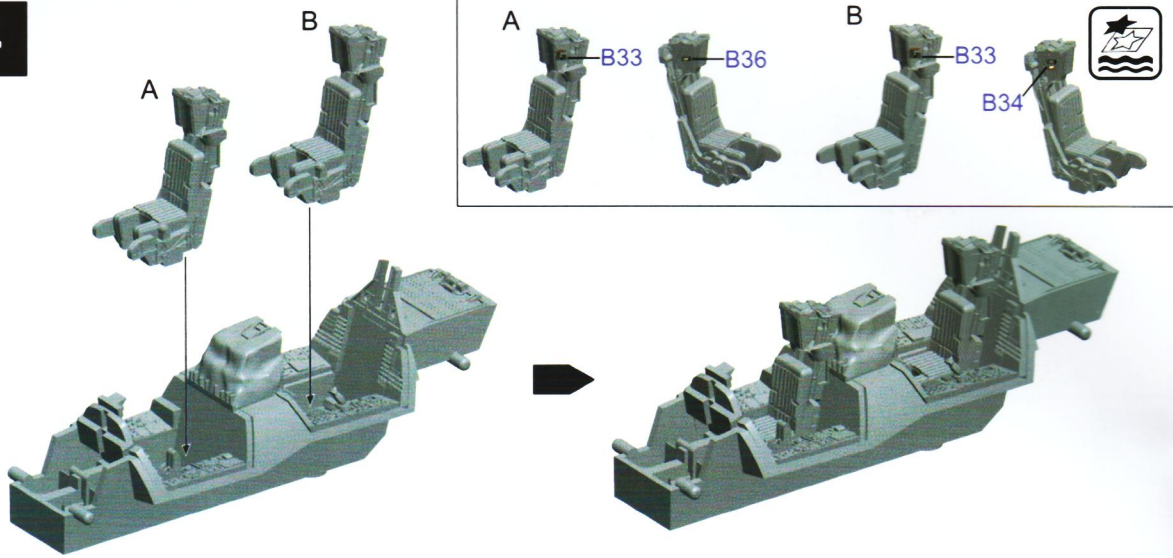

5

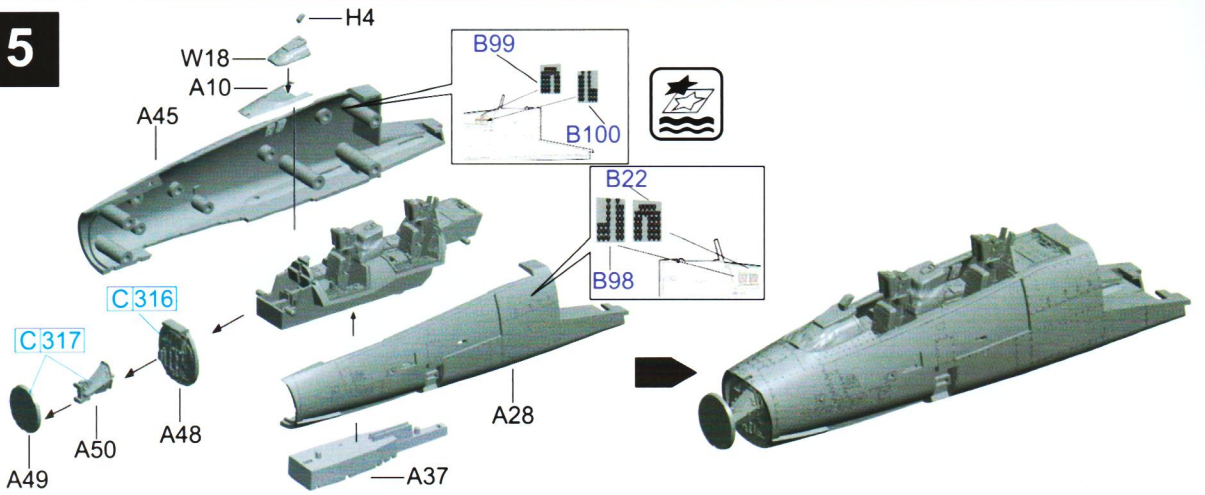

5

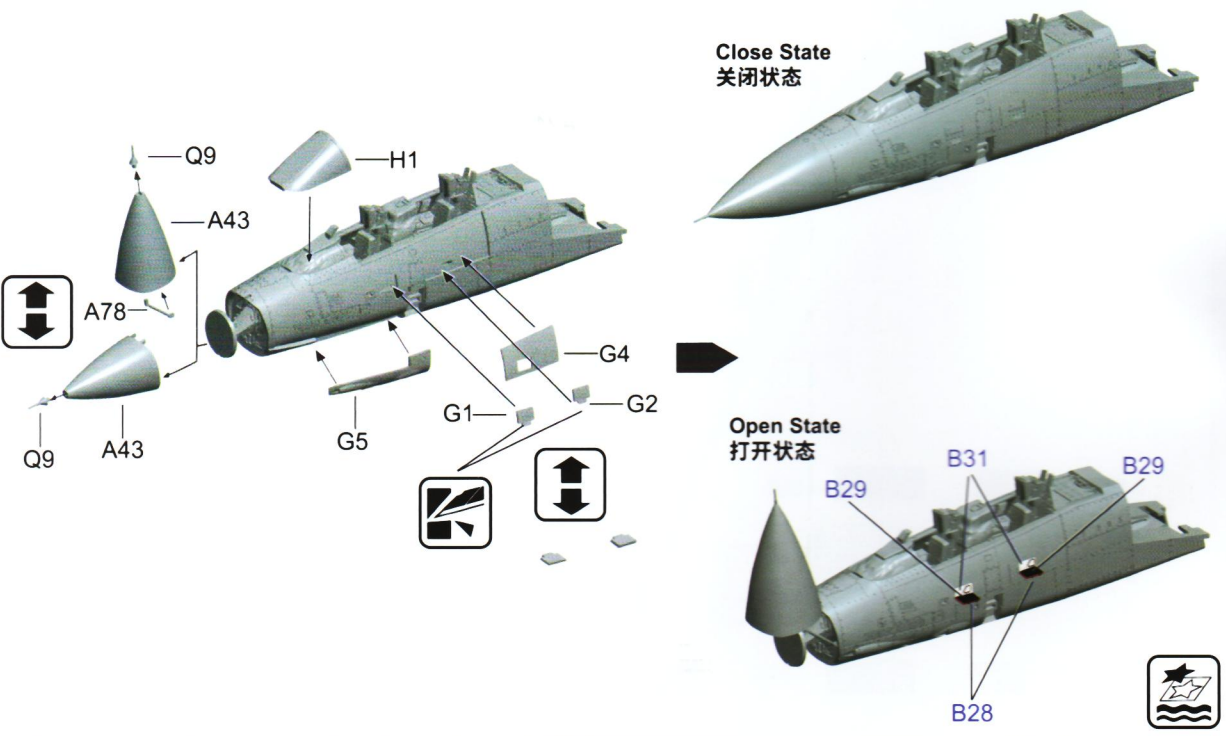

6

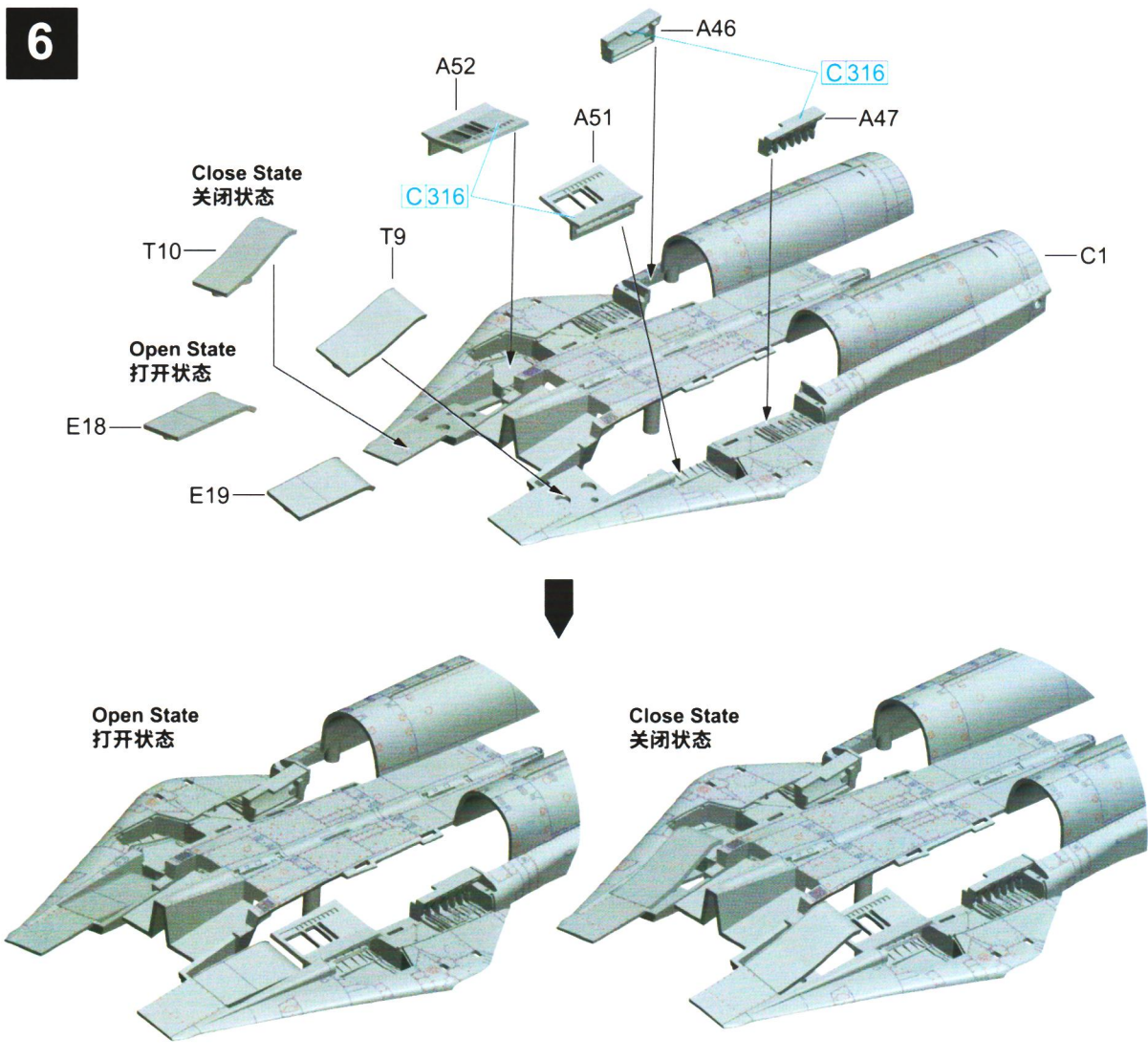

7

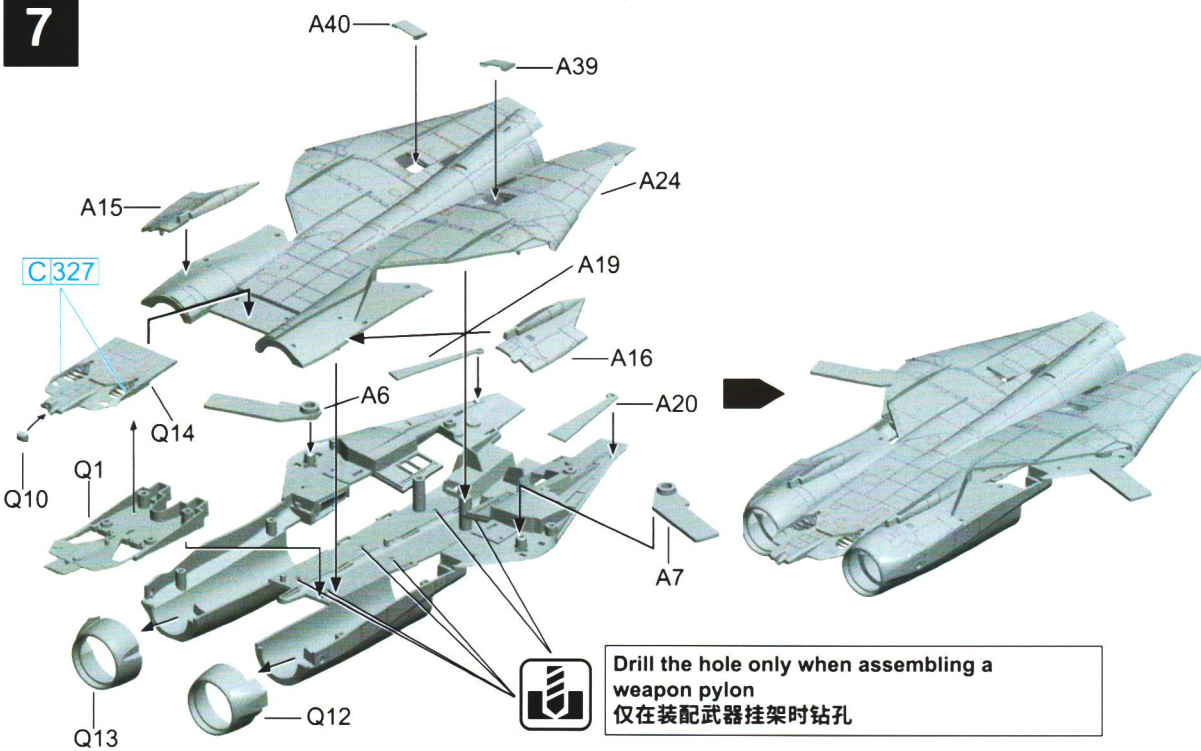

8

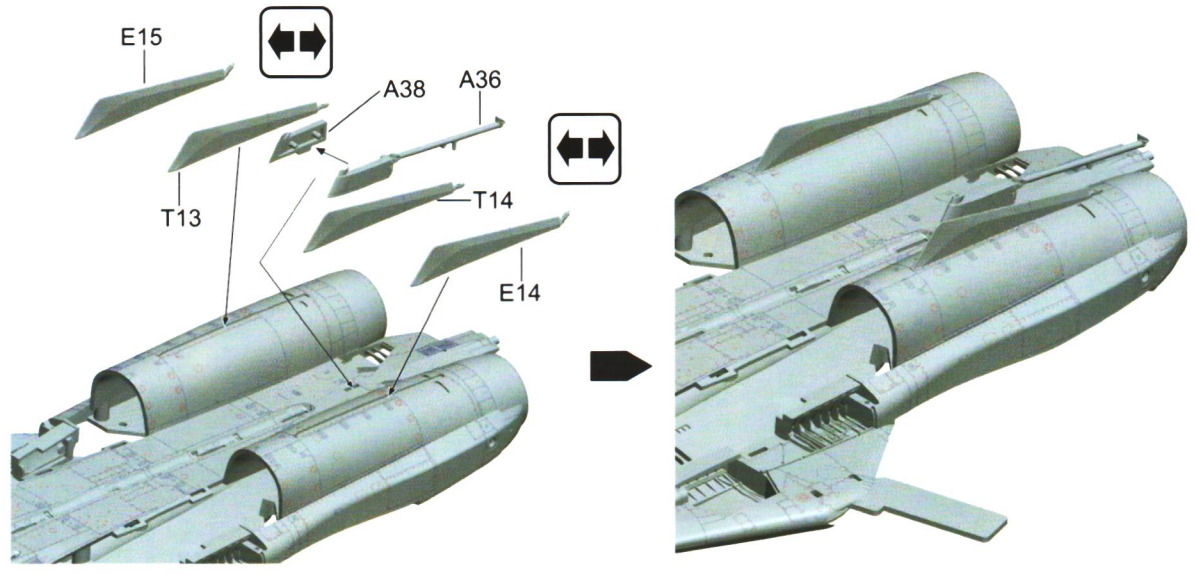

9

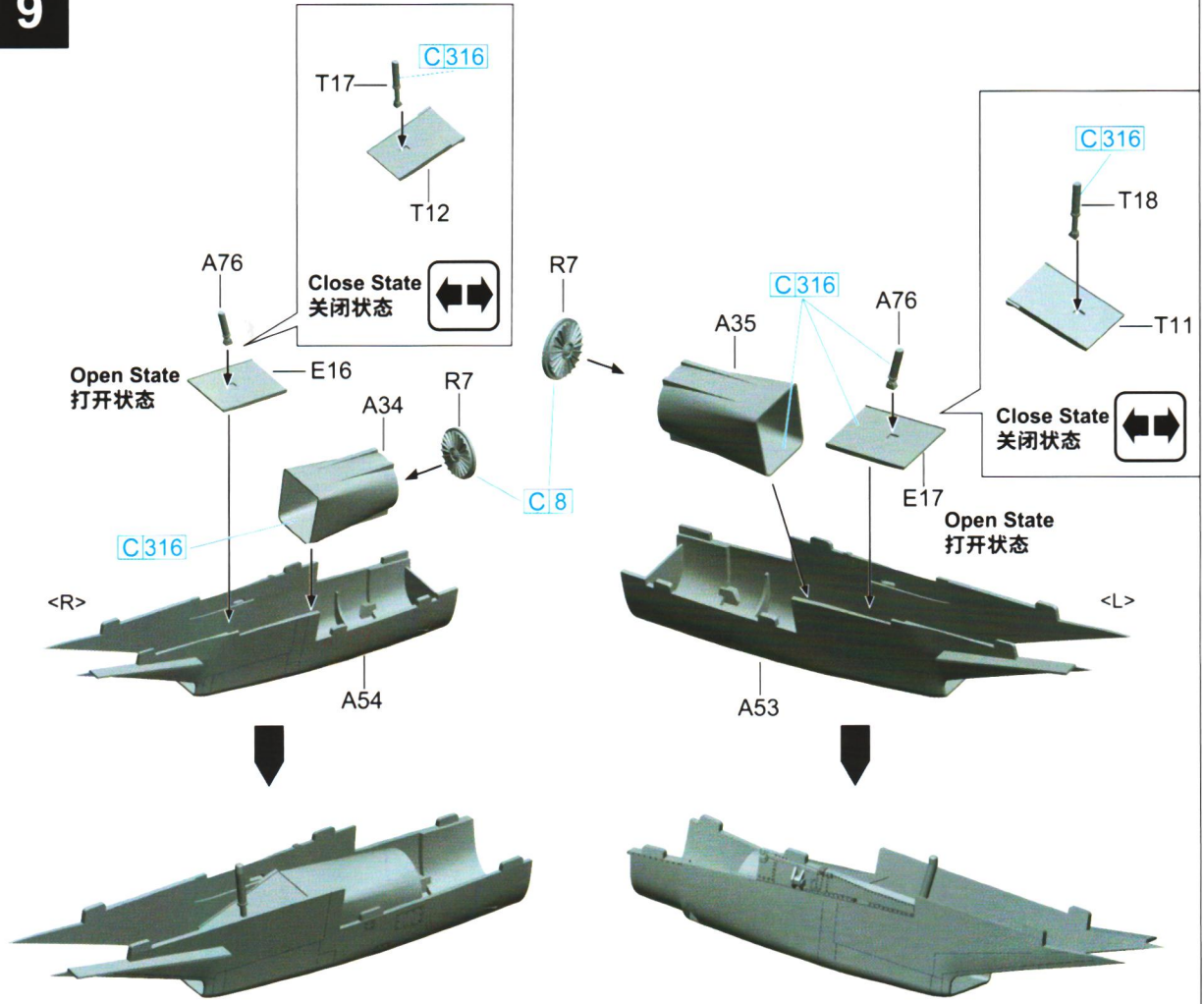

10

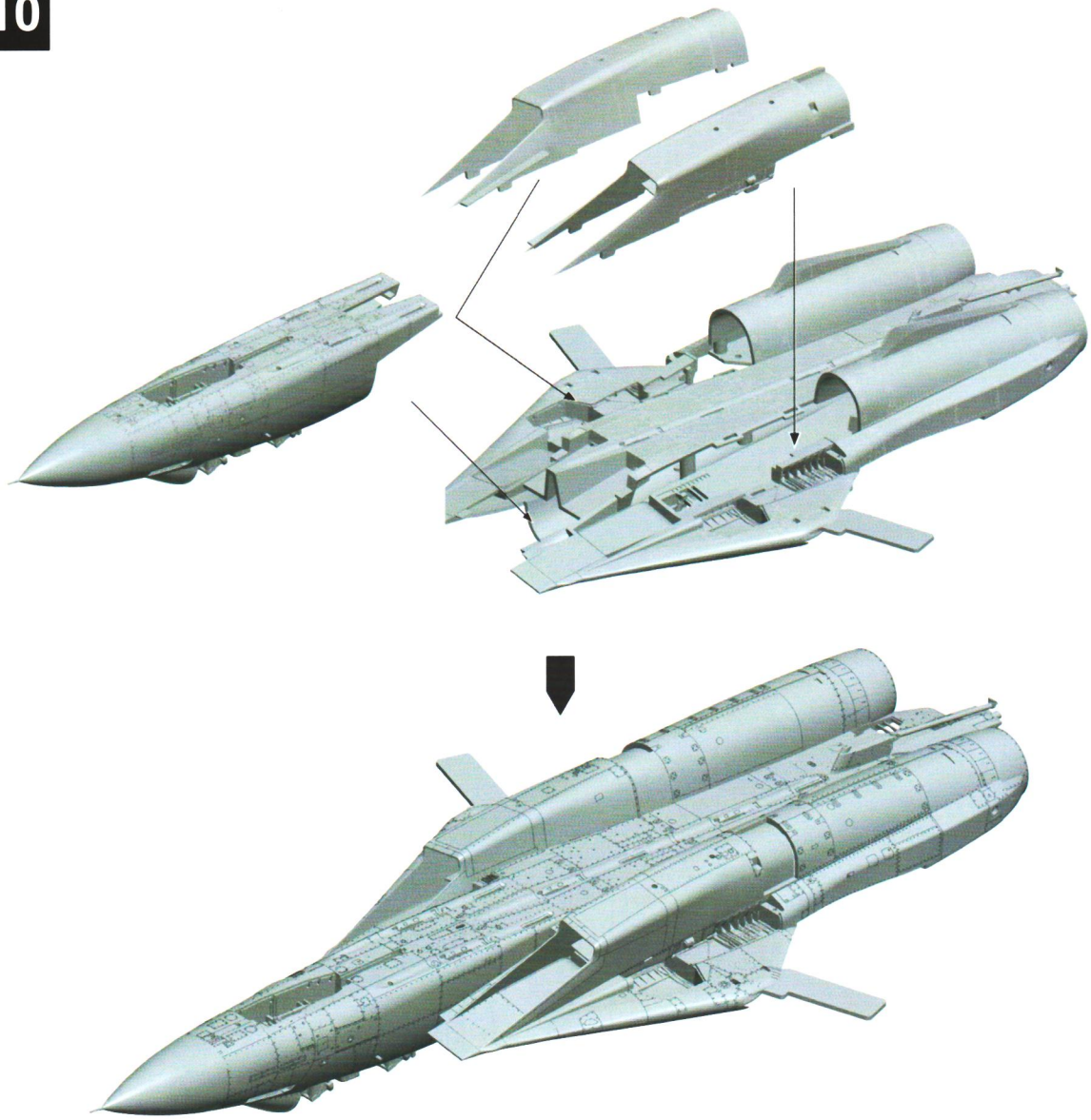

11

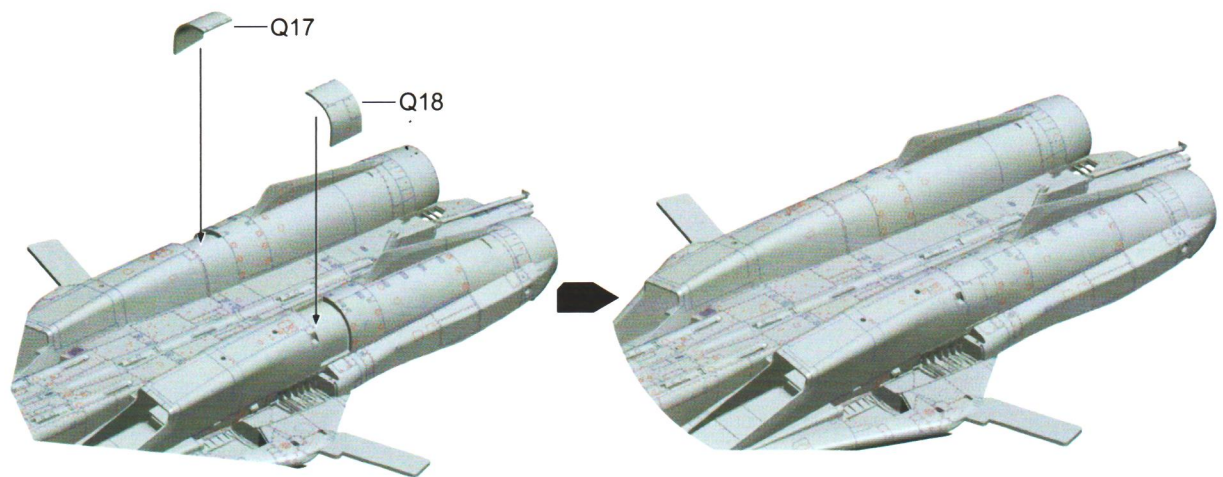

12

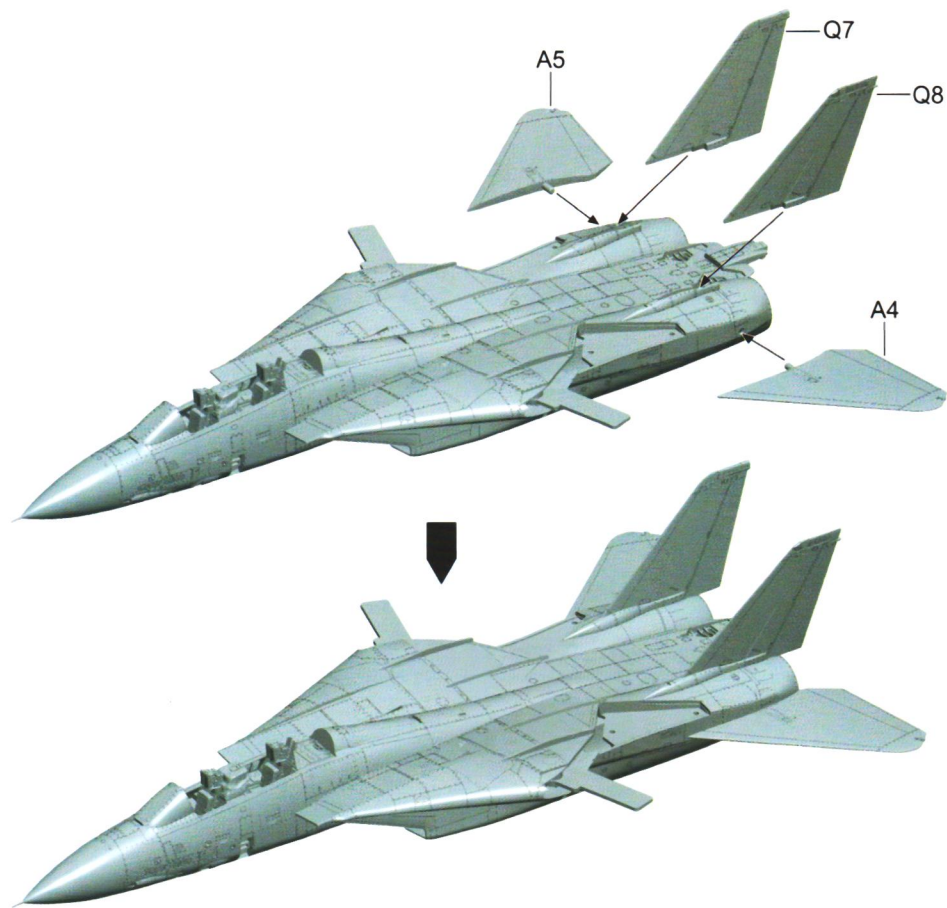

13

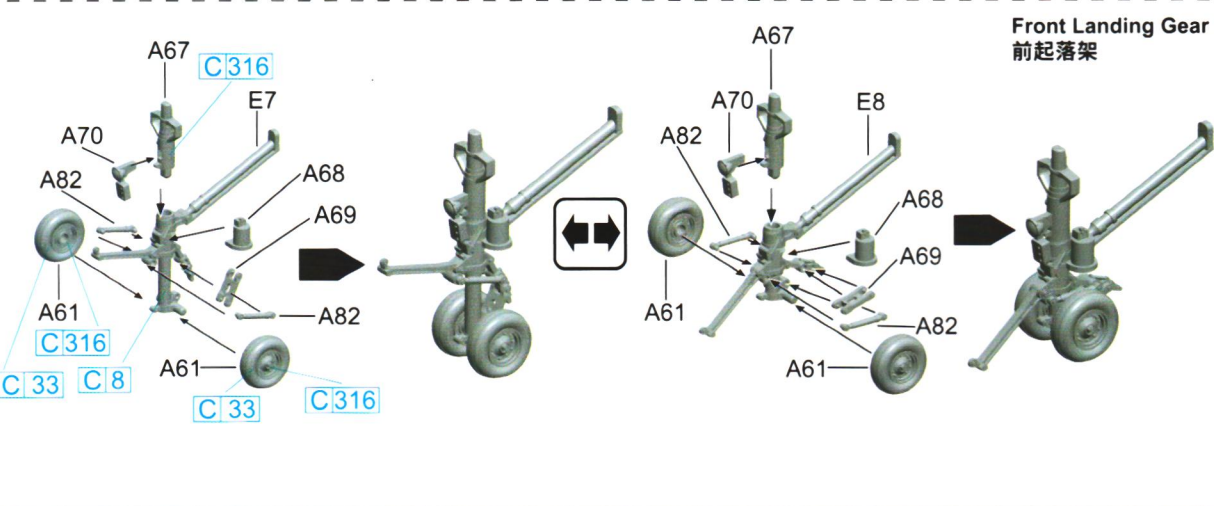
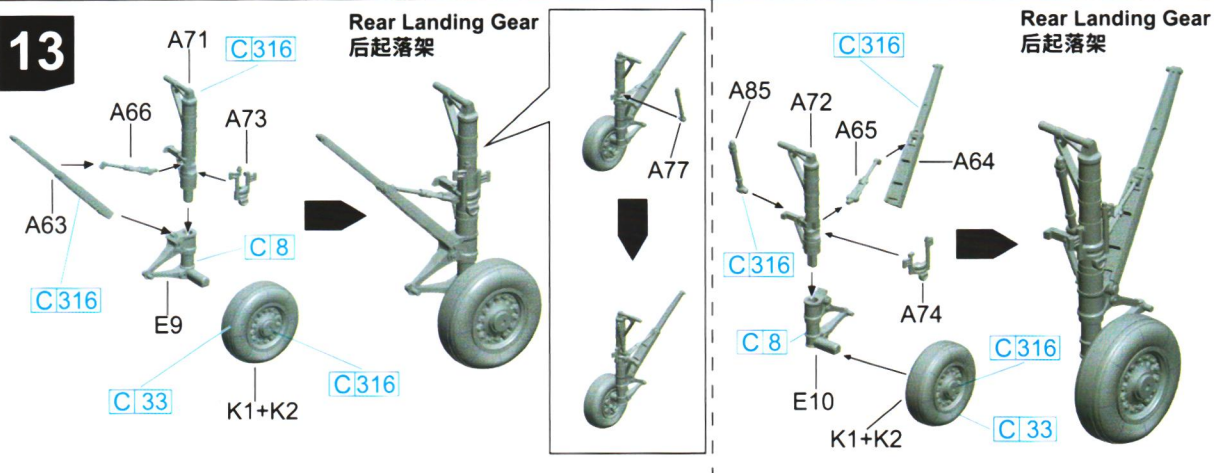

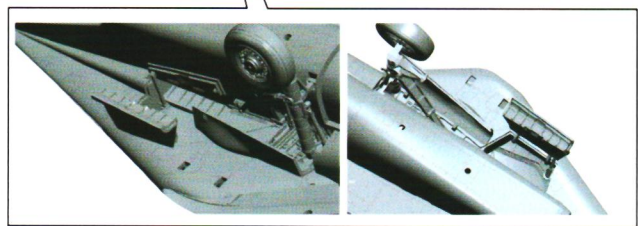
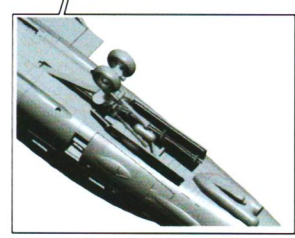
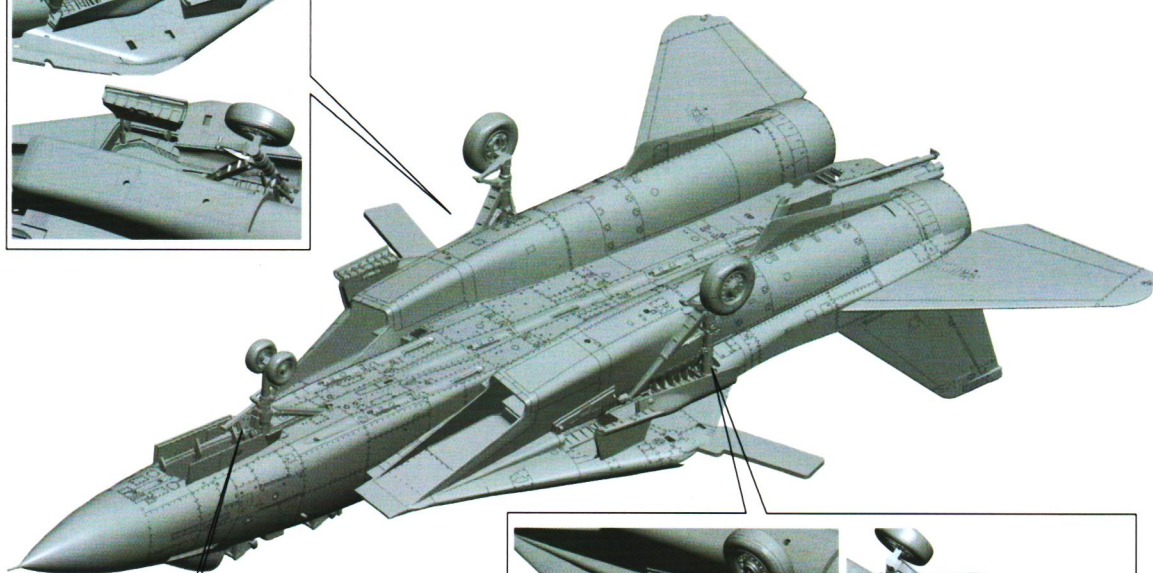
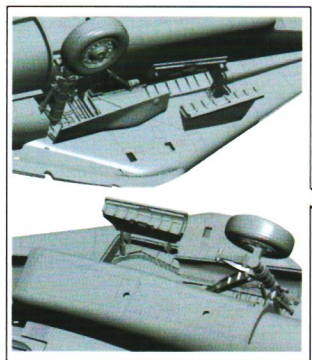
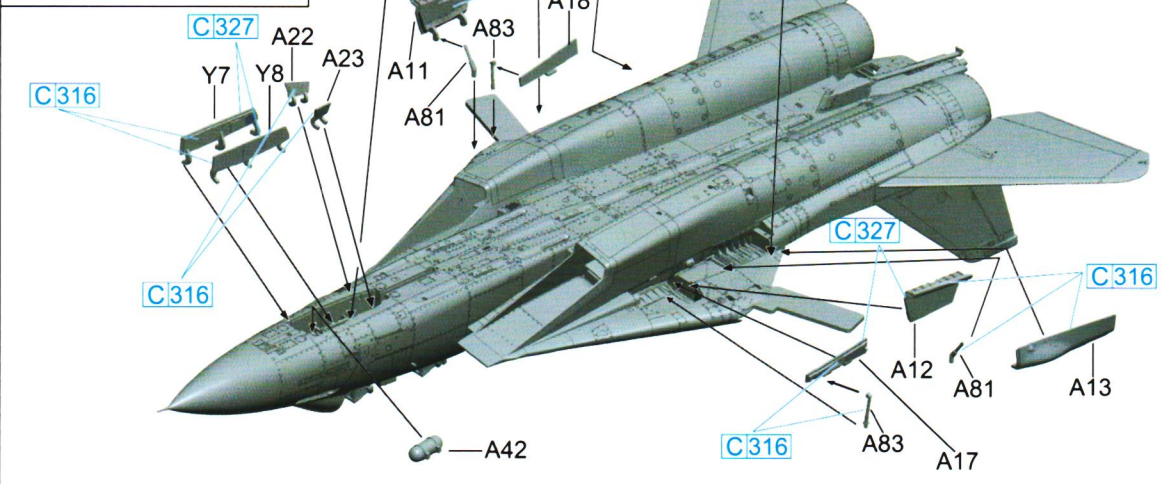
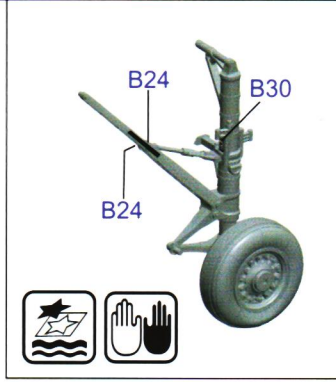
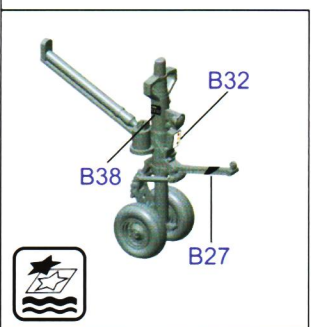

Open State
打开状态

Close State
关闭状态

15

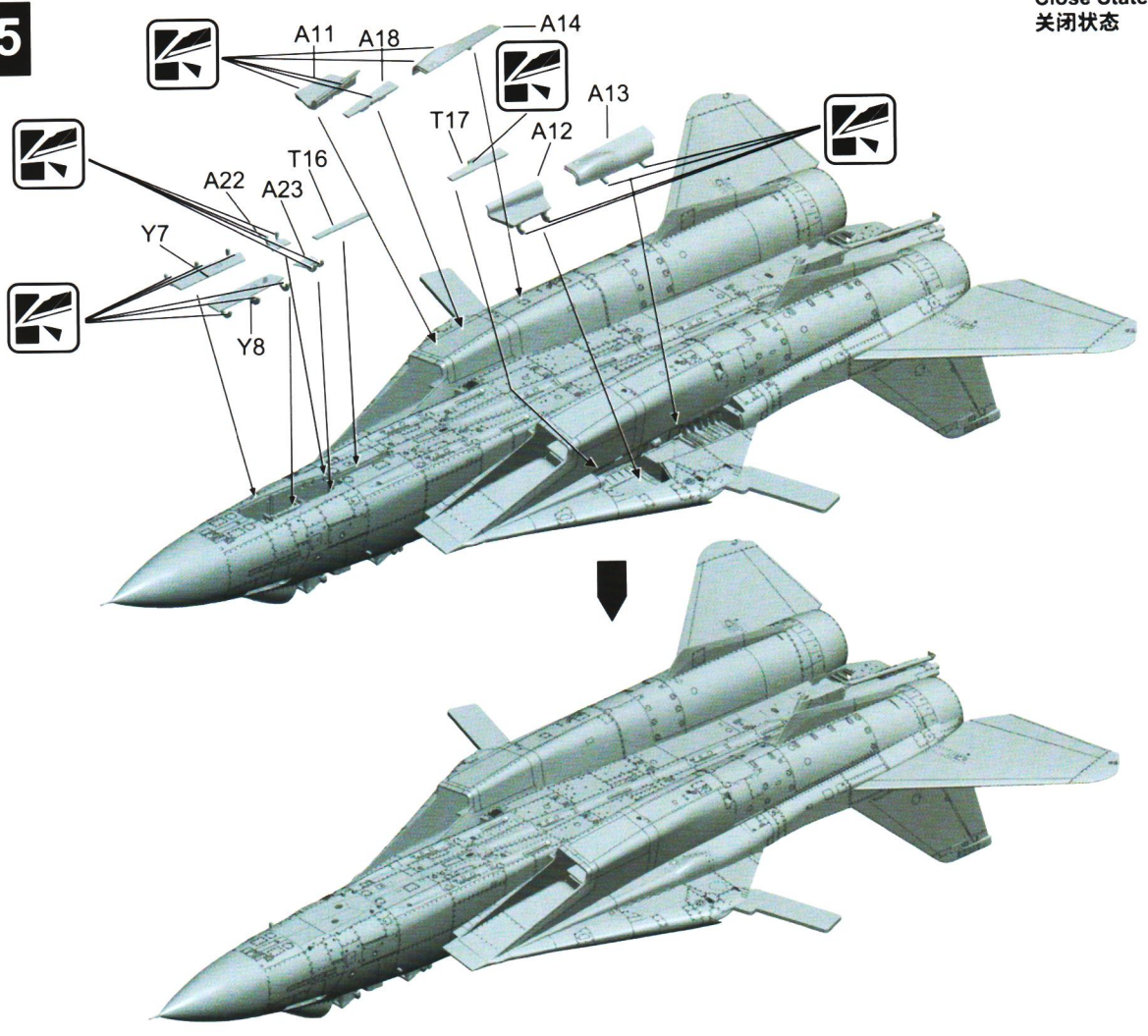

16

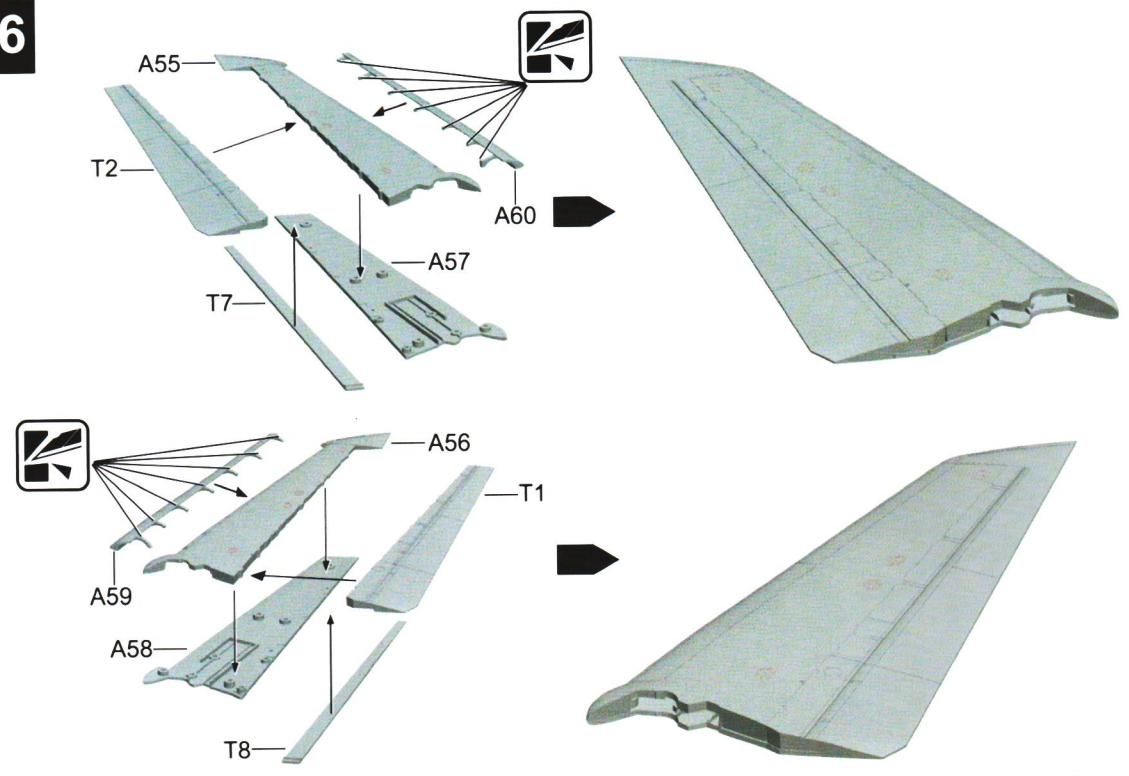

Close State
关闭状态

17

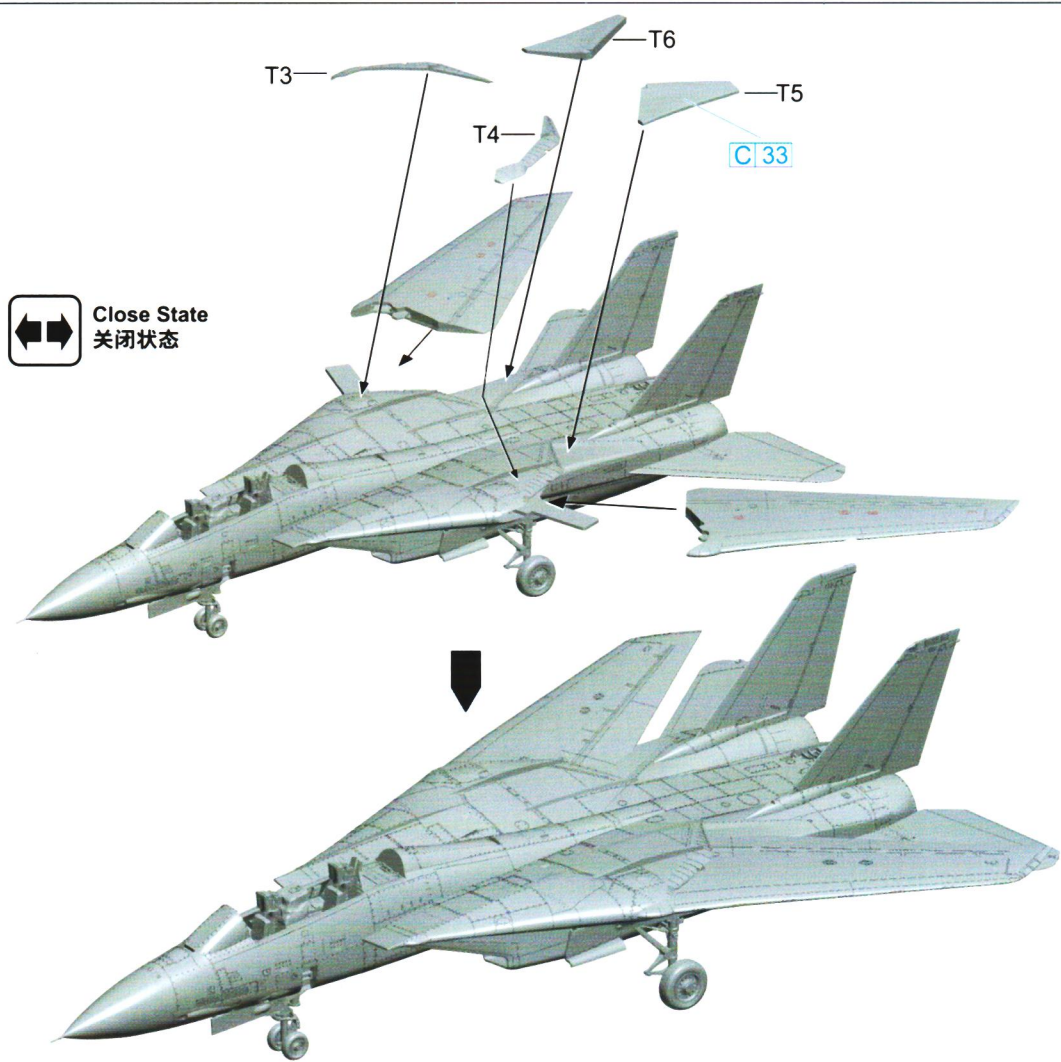

18

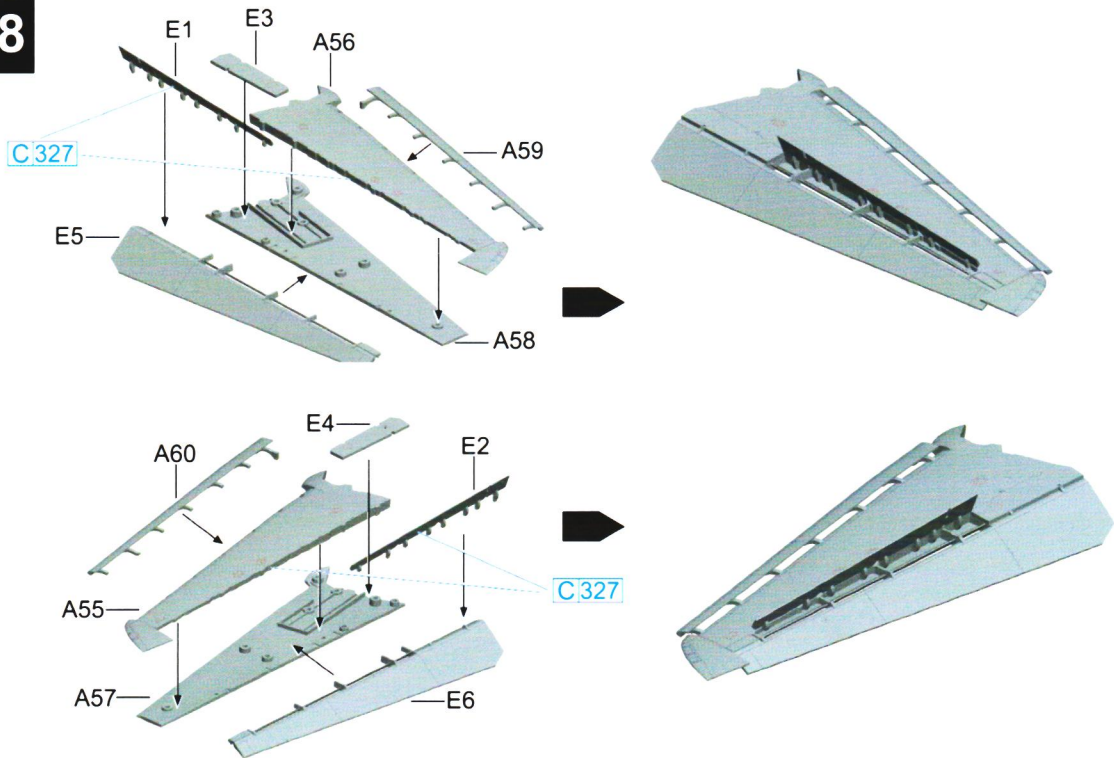

Open State
打开状态

19

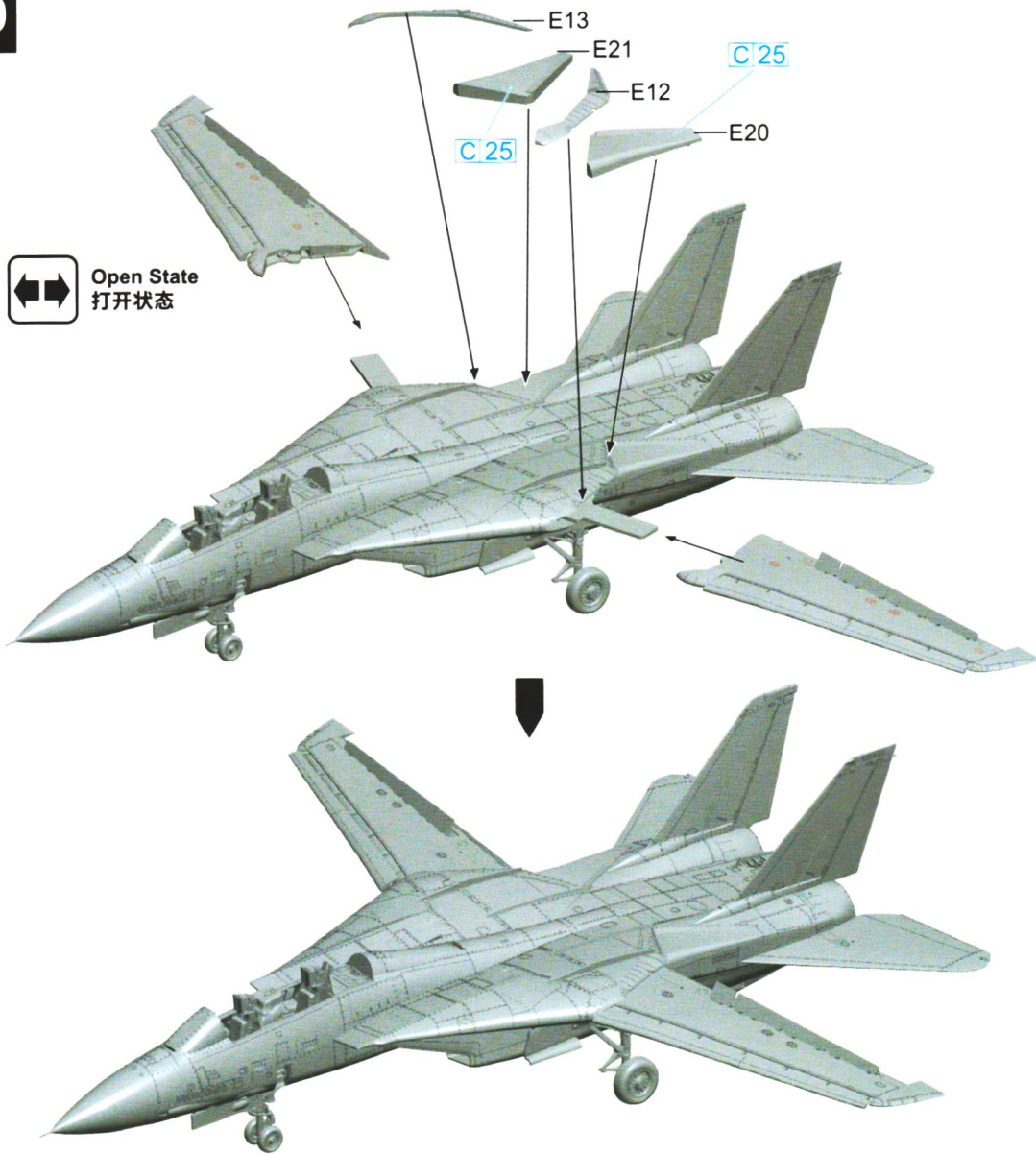

20

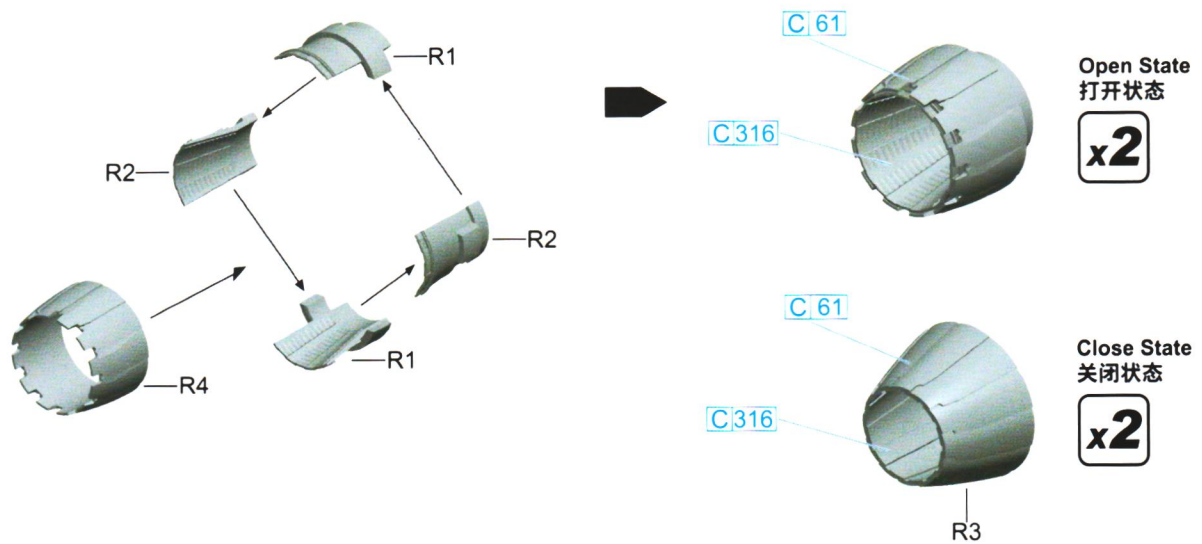

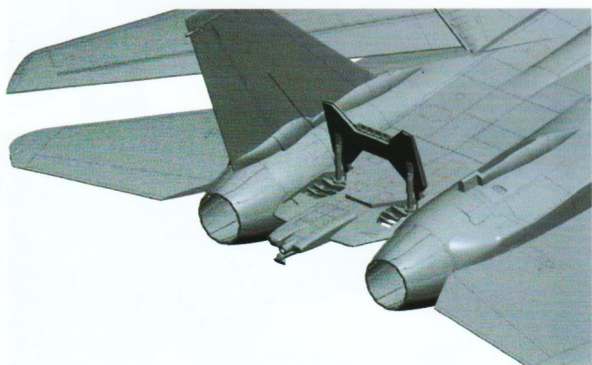
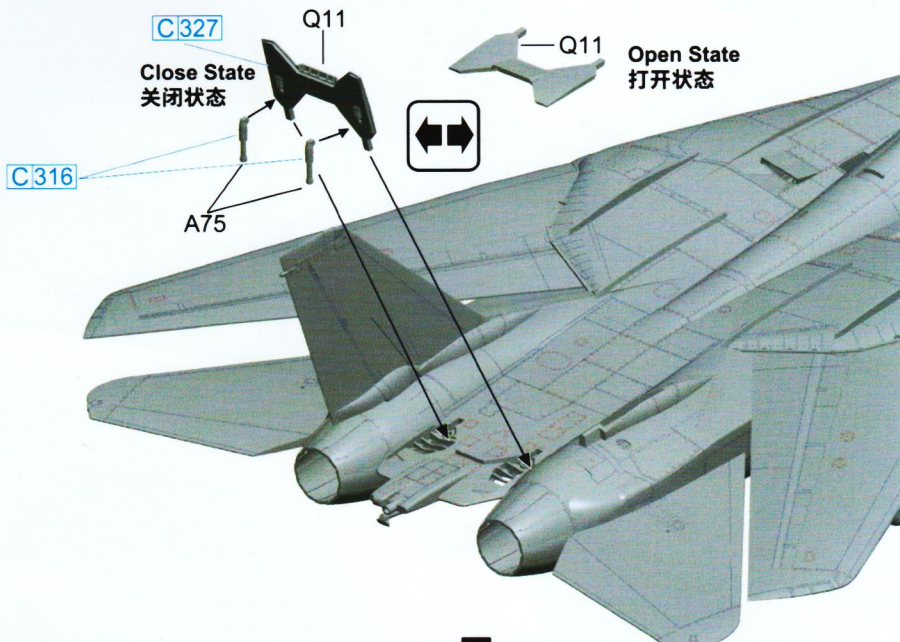
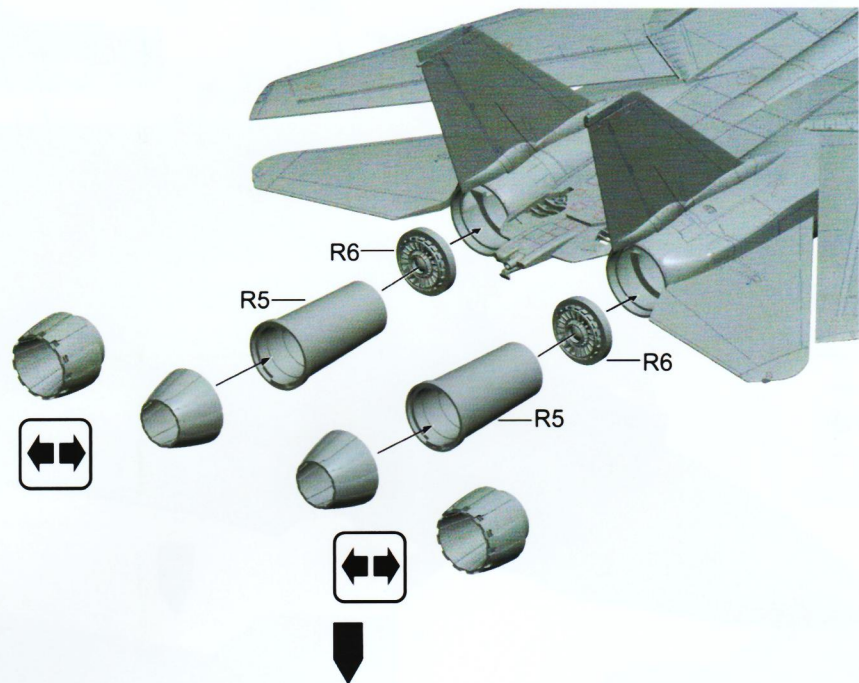

Open State
打开状态

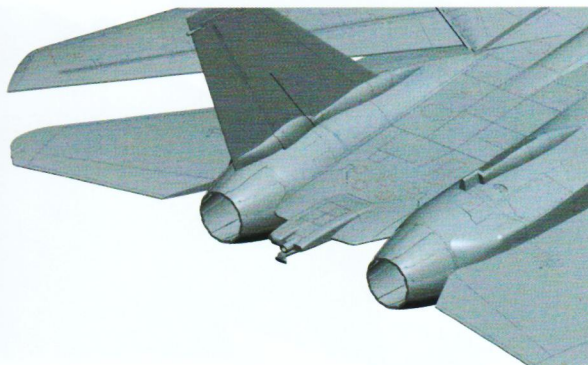

Close State
关闭状态

22

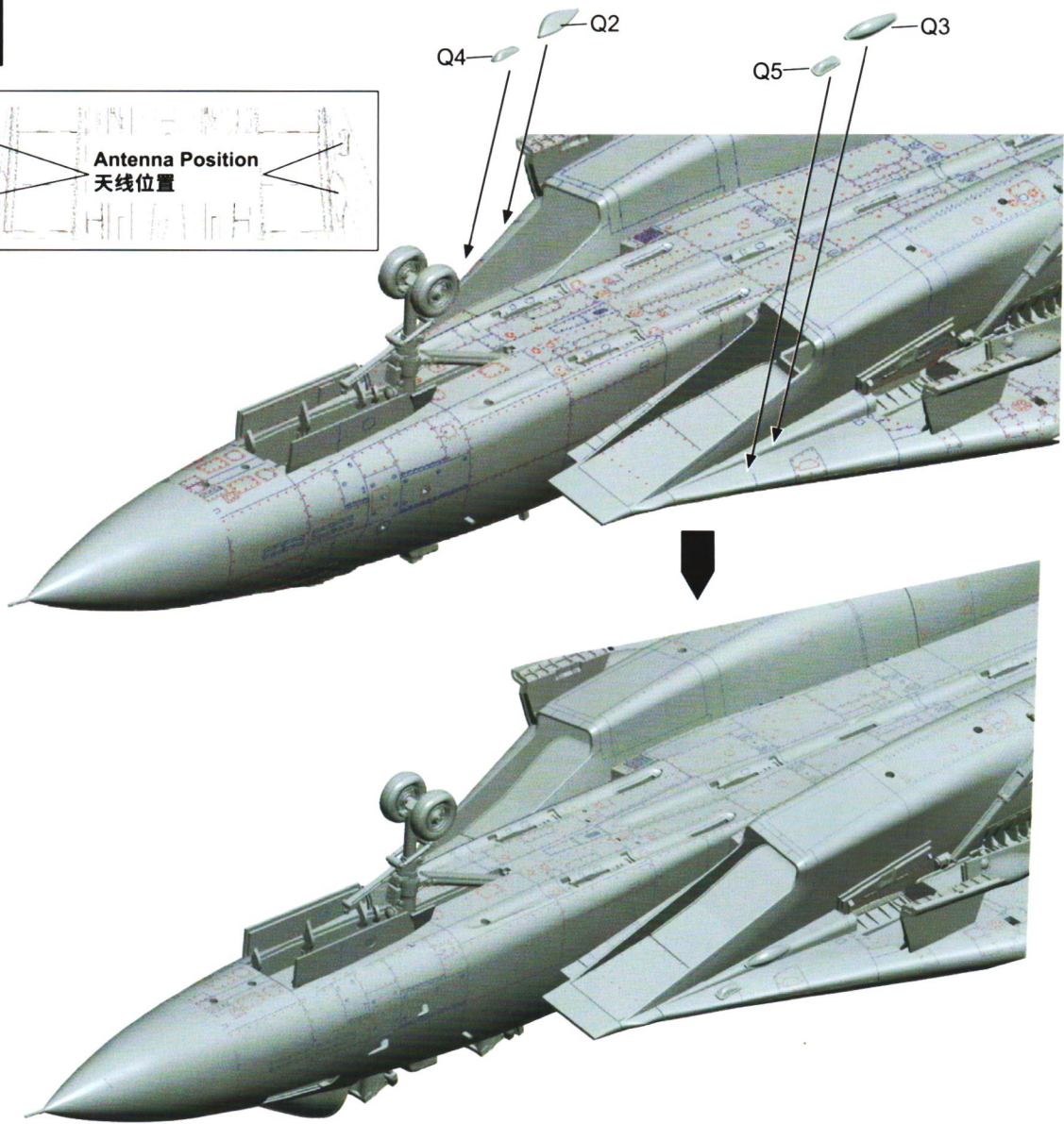
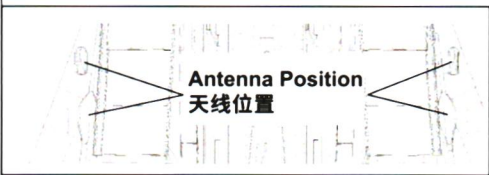

23

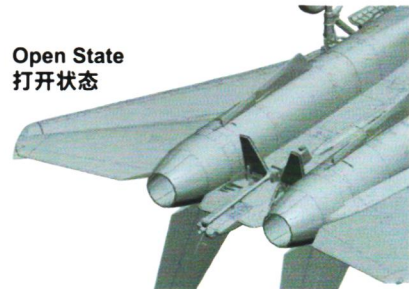
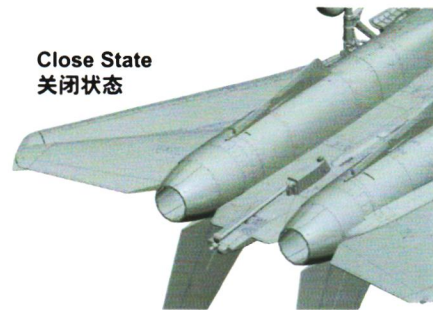
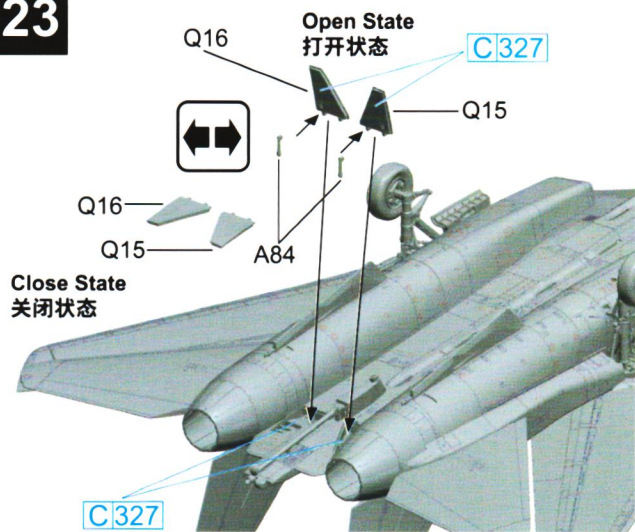

24

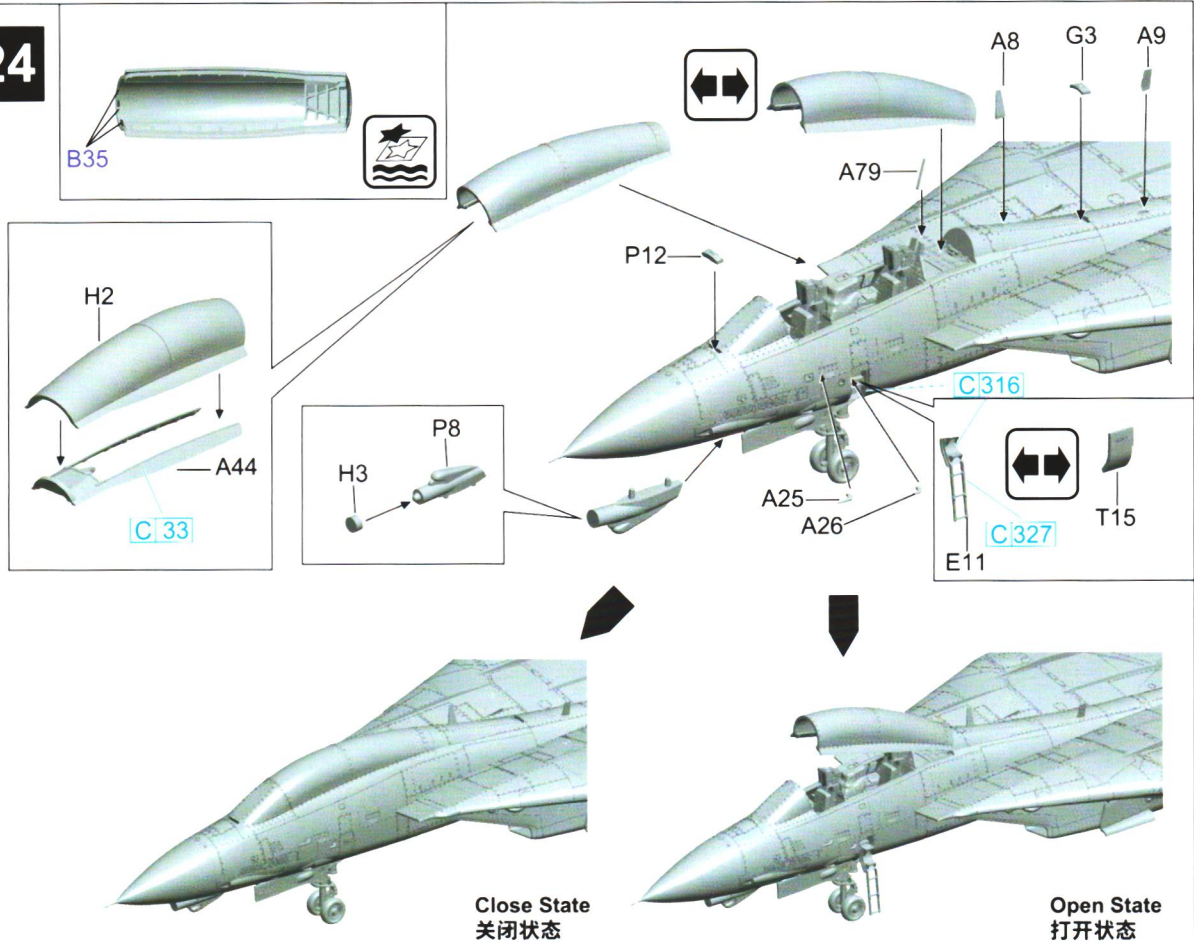

Close State
关闭状态

Open State
打开状态

25

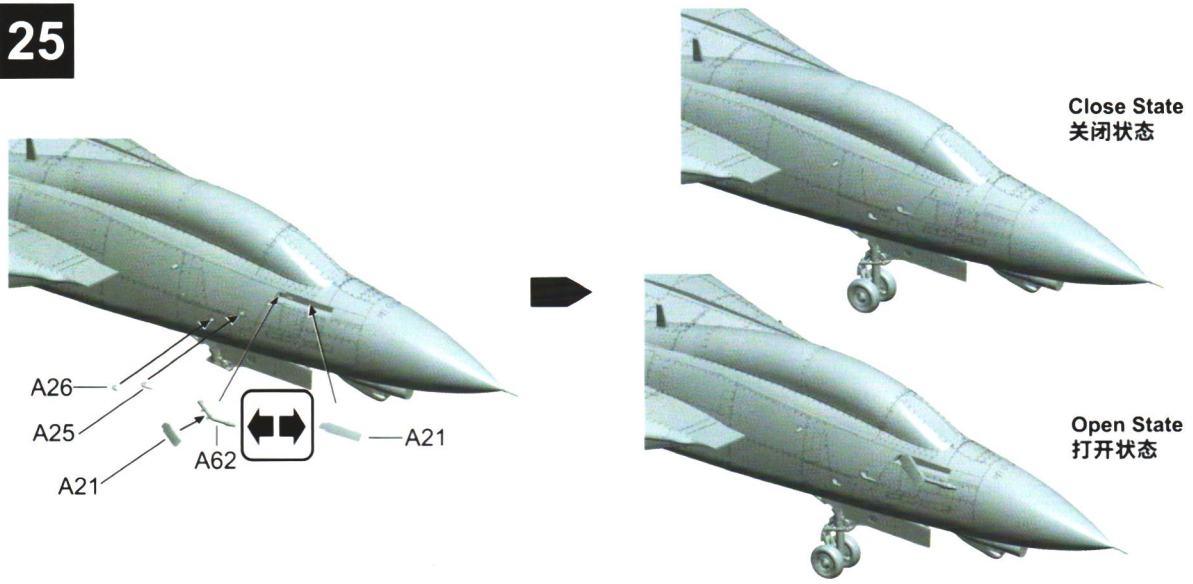

Close State
关闭状态

Open State
打开状态

26

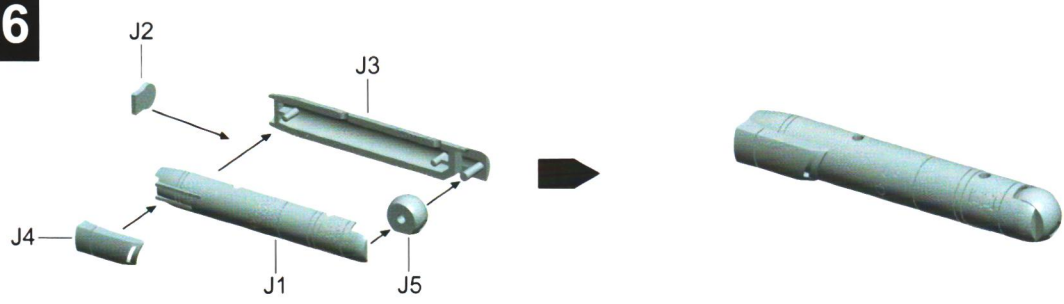

27

GBU-12

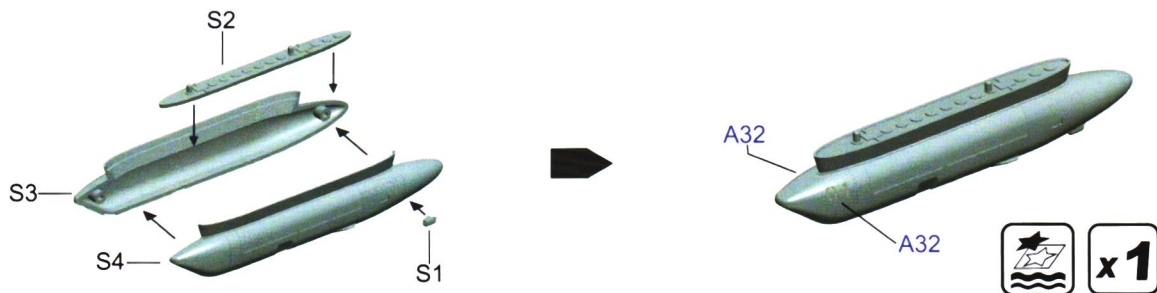
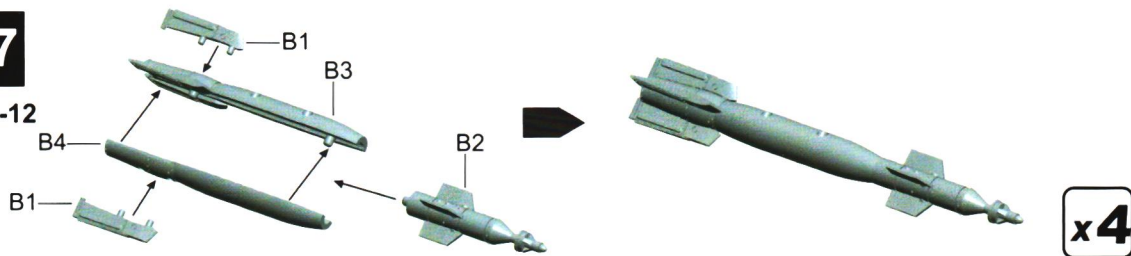

AIM-54

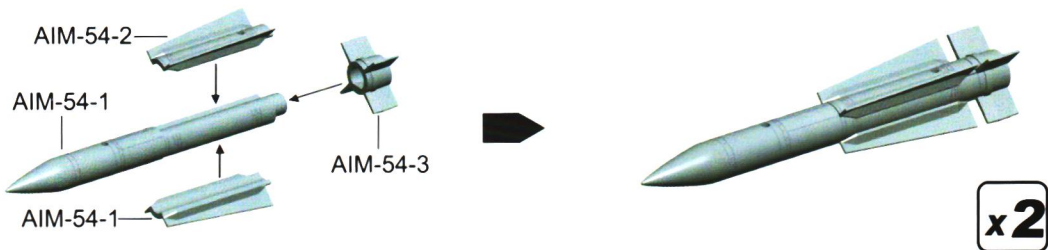

TANK

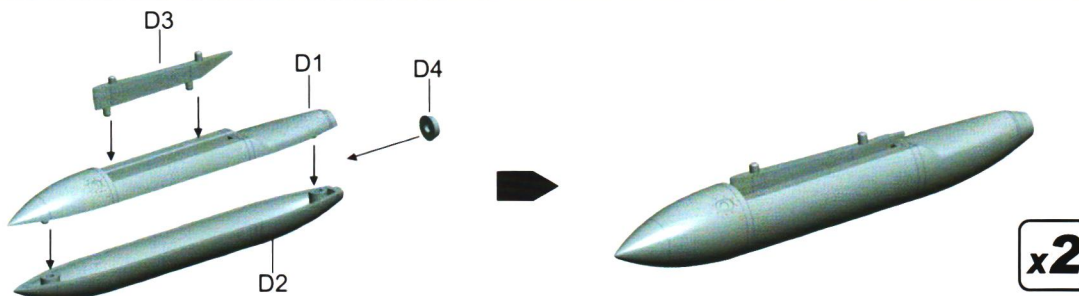

AIM-7

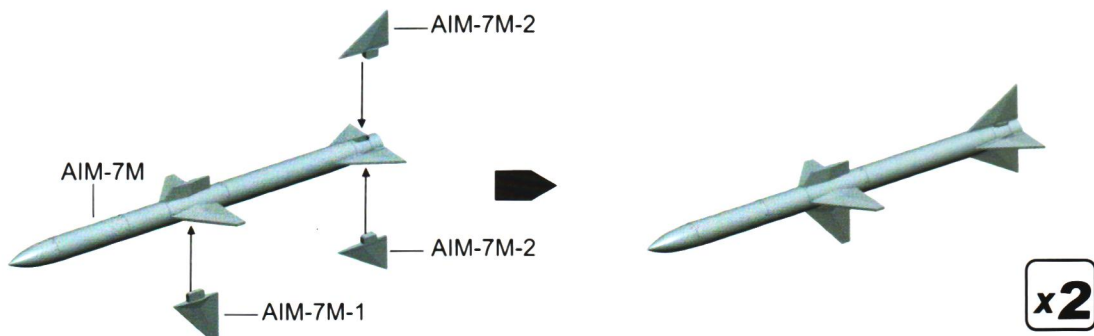

AIM-9



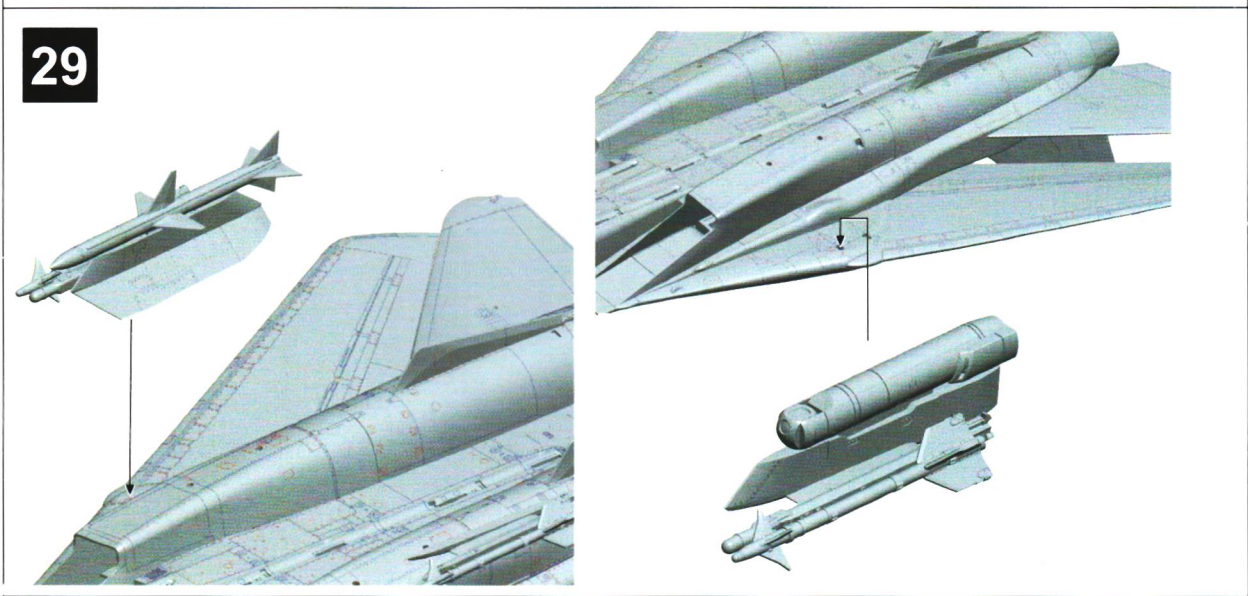
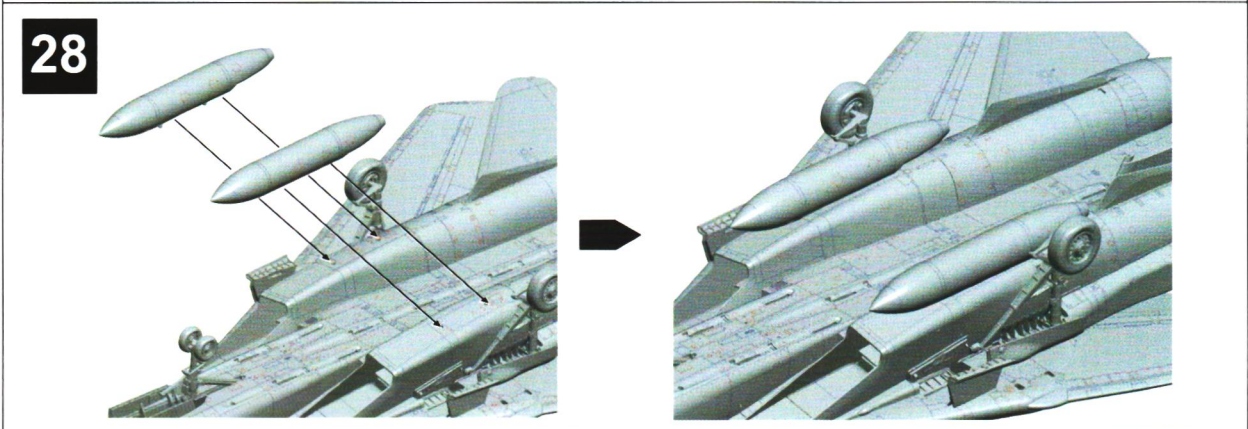
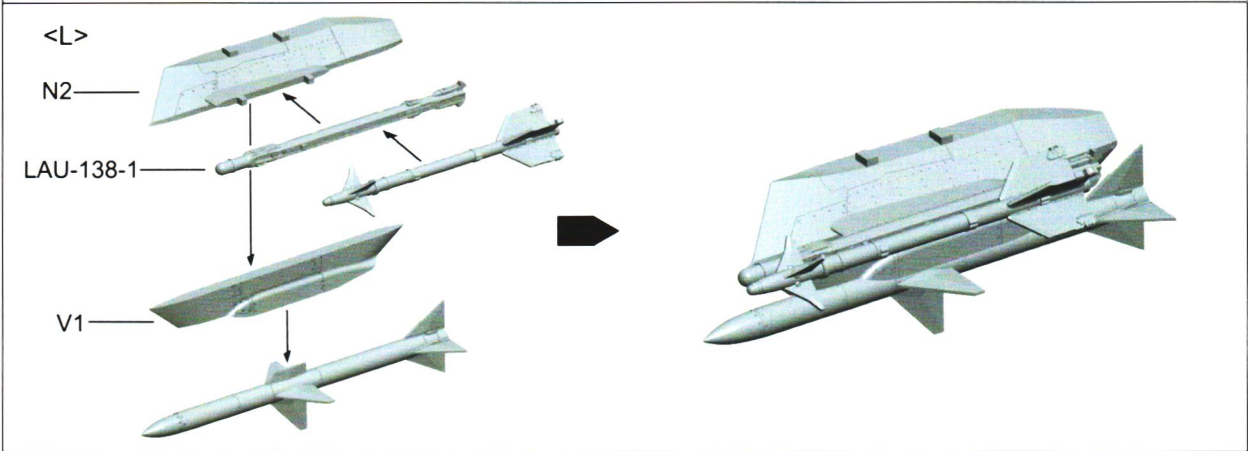
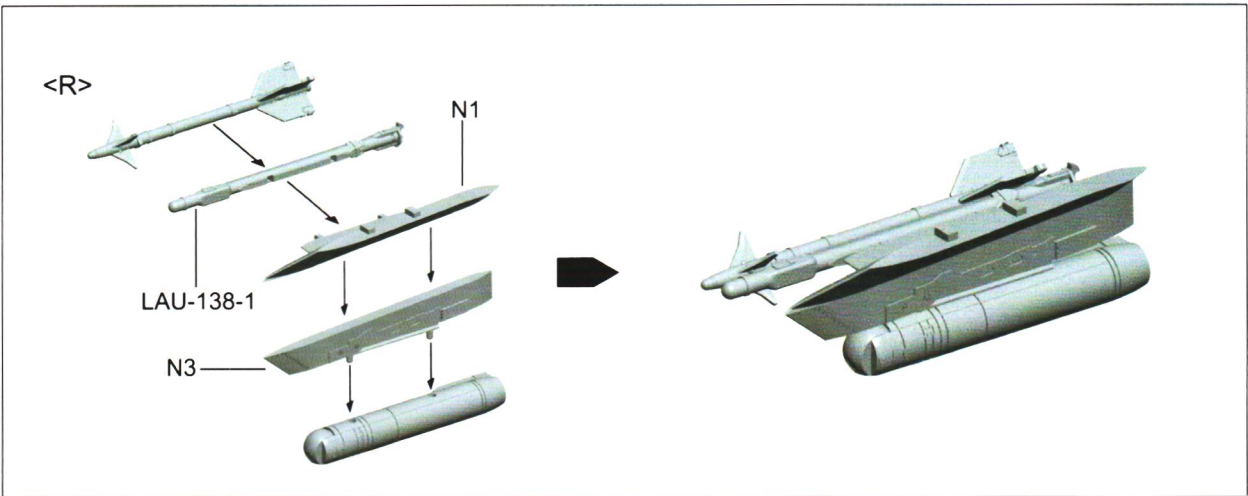

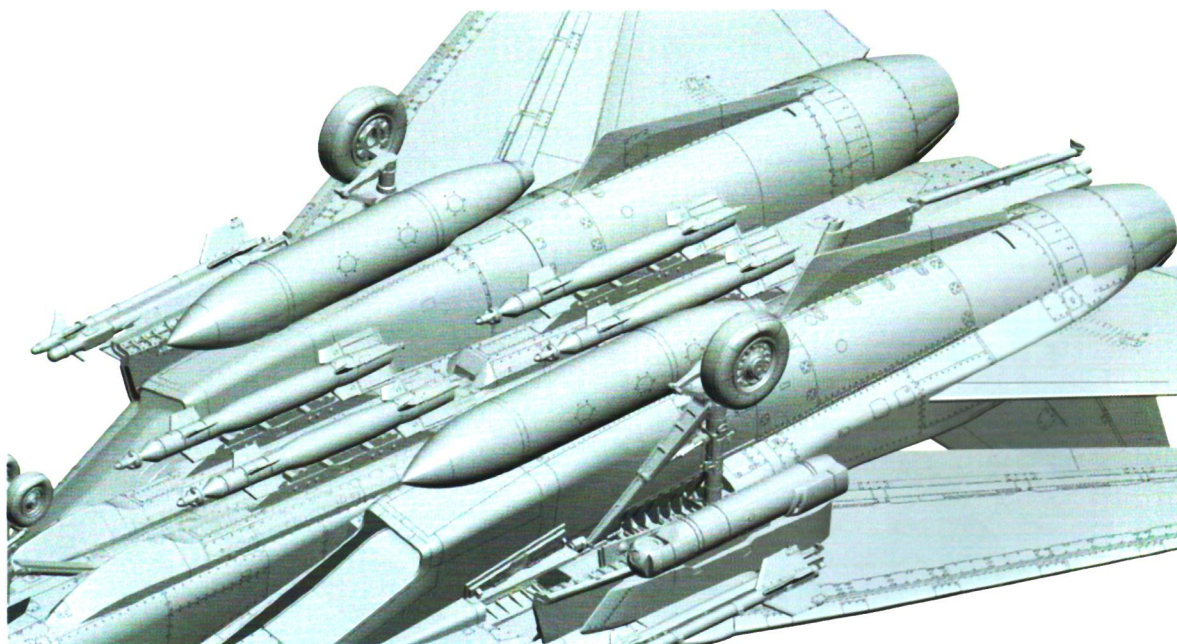
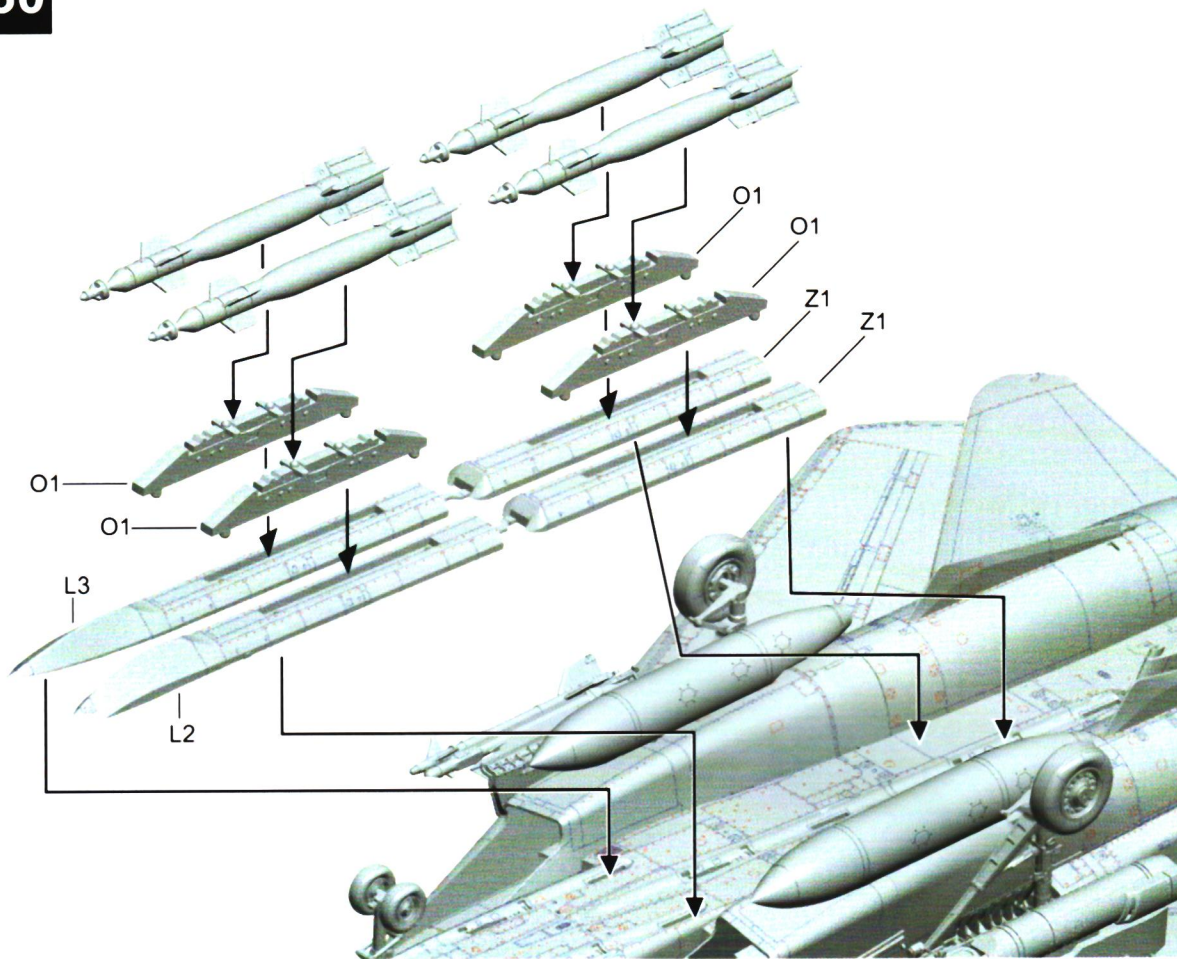

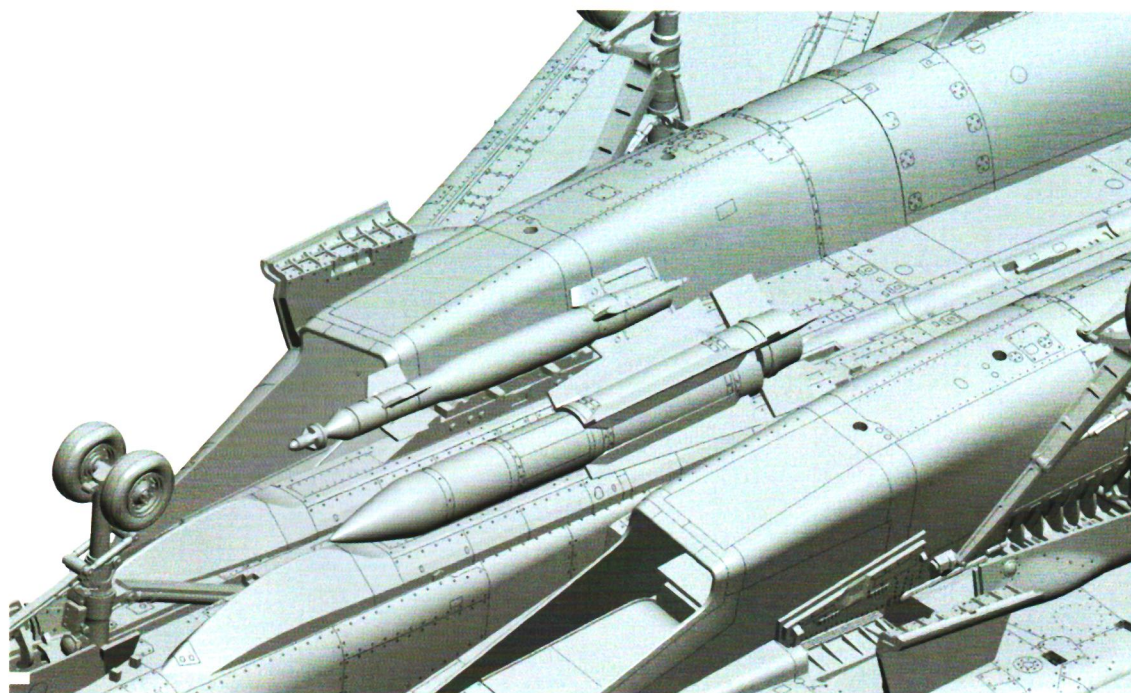
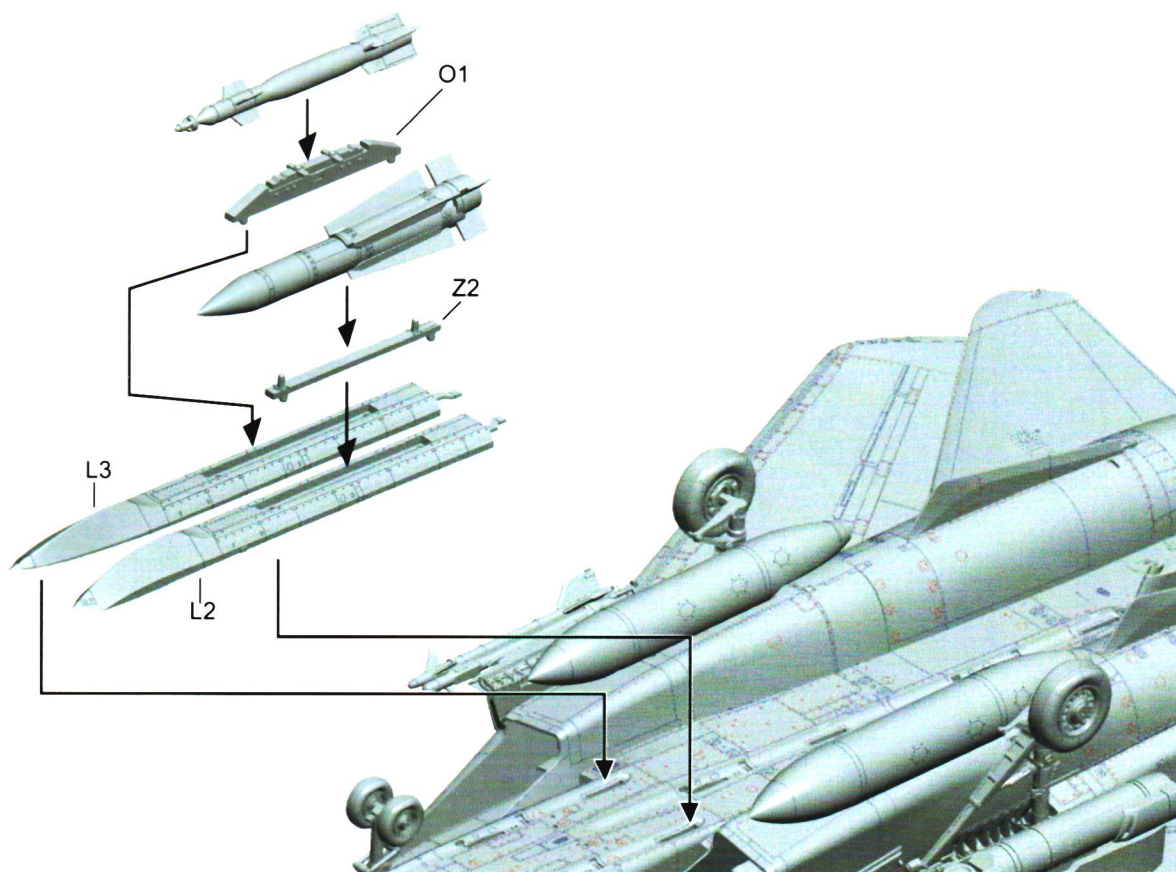

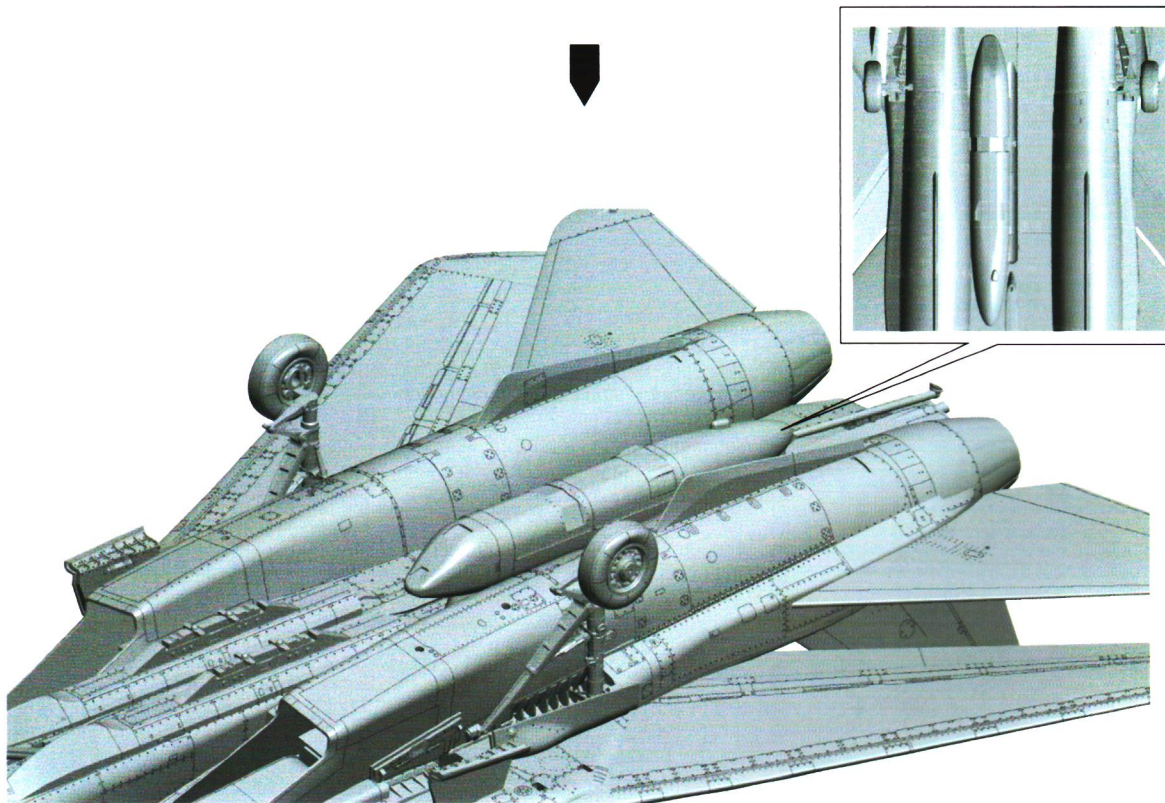
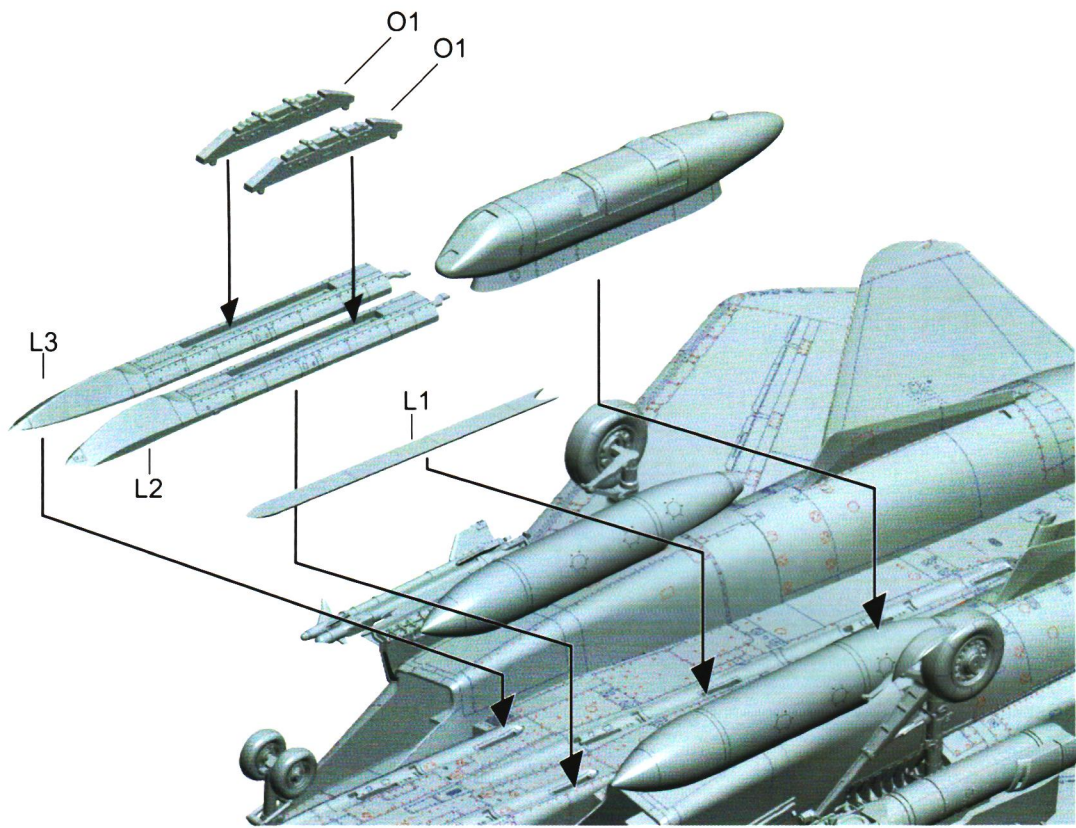

A F-14B 163217 AA103 VF-103 “海盗旗”中队，“奥申纳”海军航空站，2004
 F-14B 163217 AA103 VF-103 “JOLLY ROGERS”，“OCEANA”NAS，2004

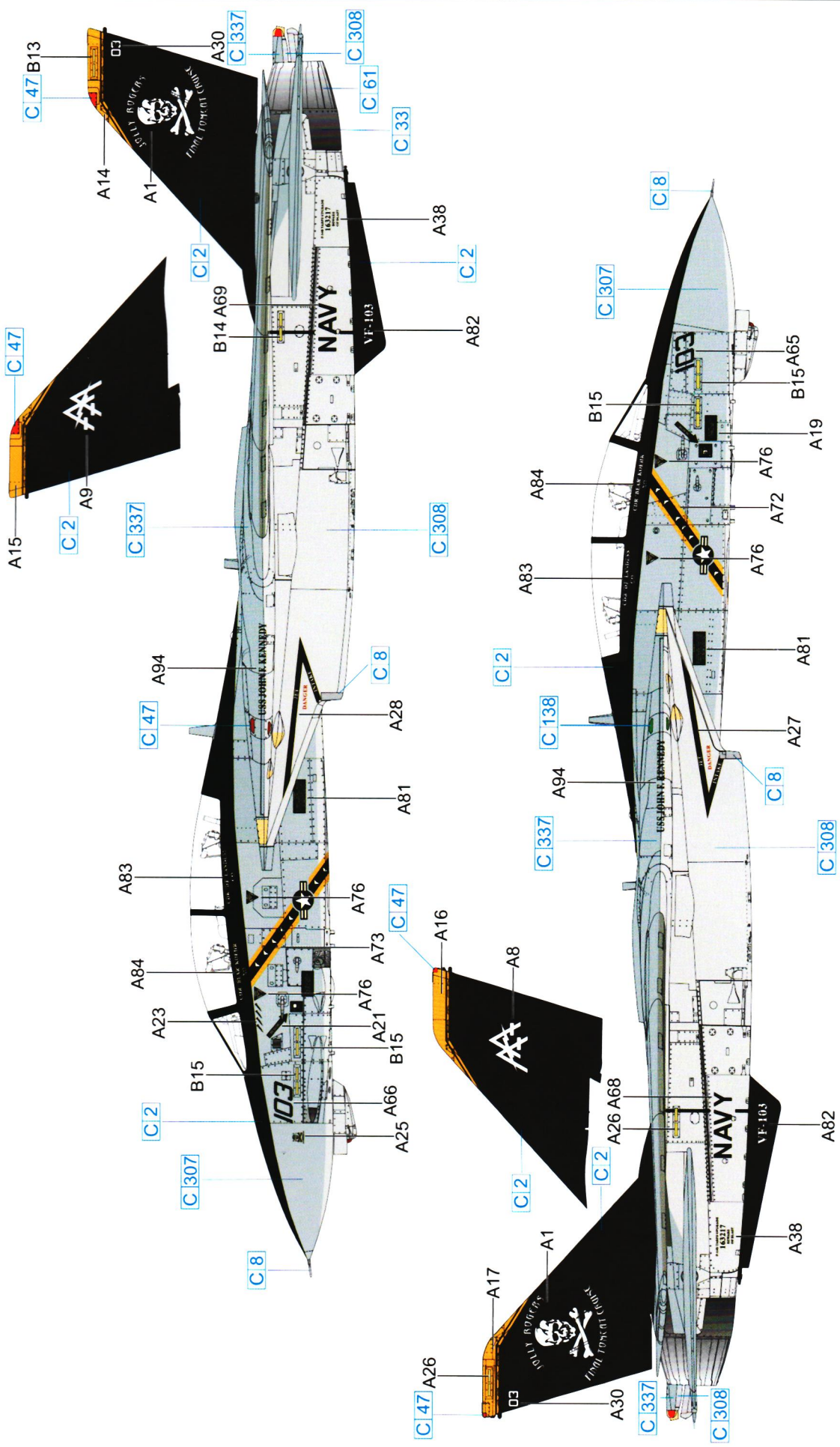

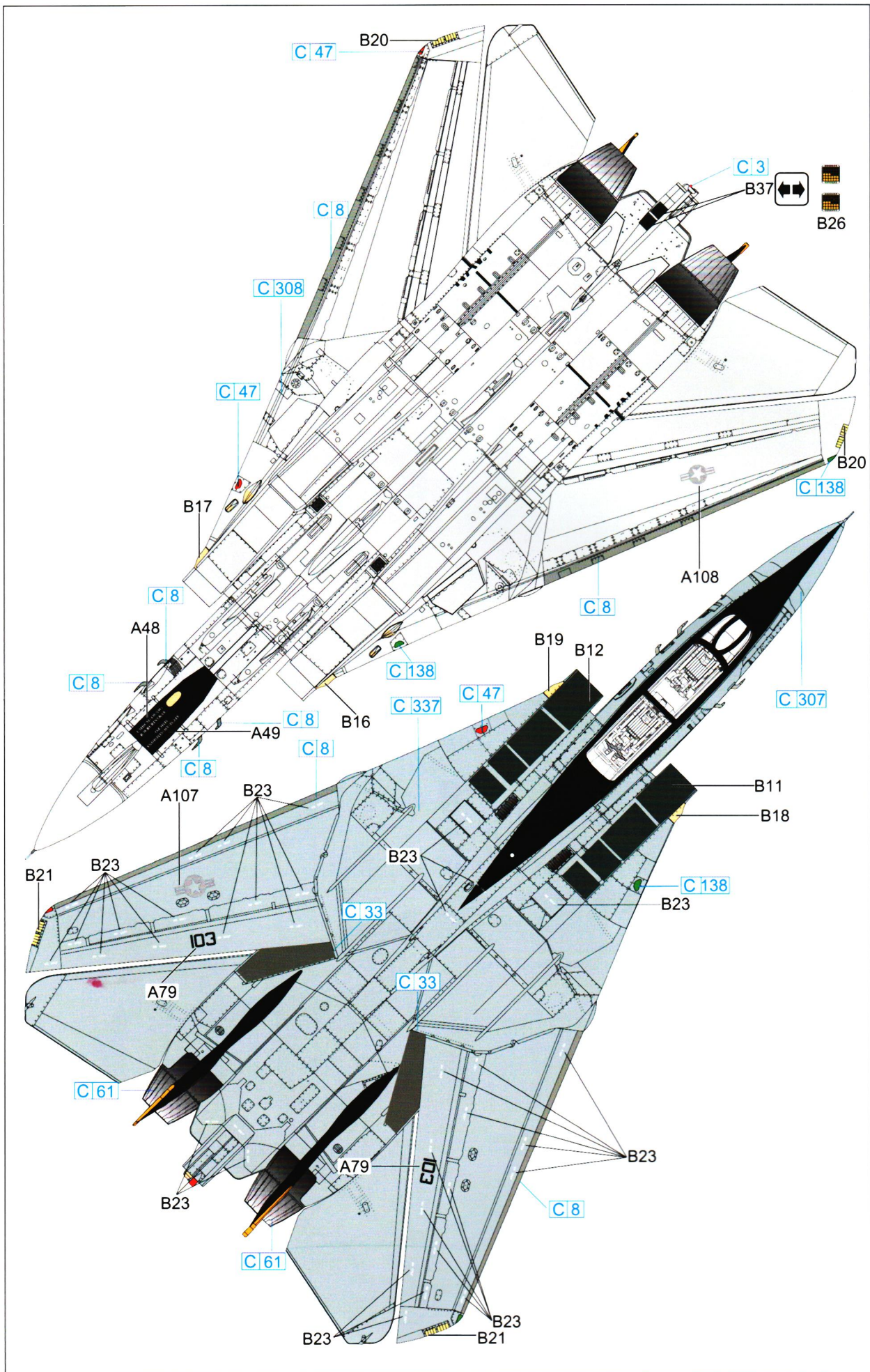

B F-14B 163217 AA110 VF-103 “海盜旗”中队, “肯尼迪”号航空母舰, 2004
 F-14B 163217 AA110 VF-103 “JOLLY ROGERS”, “USS JOHN F. KENNEDY CV-67”, 2004

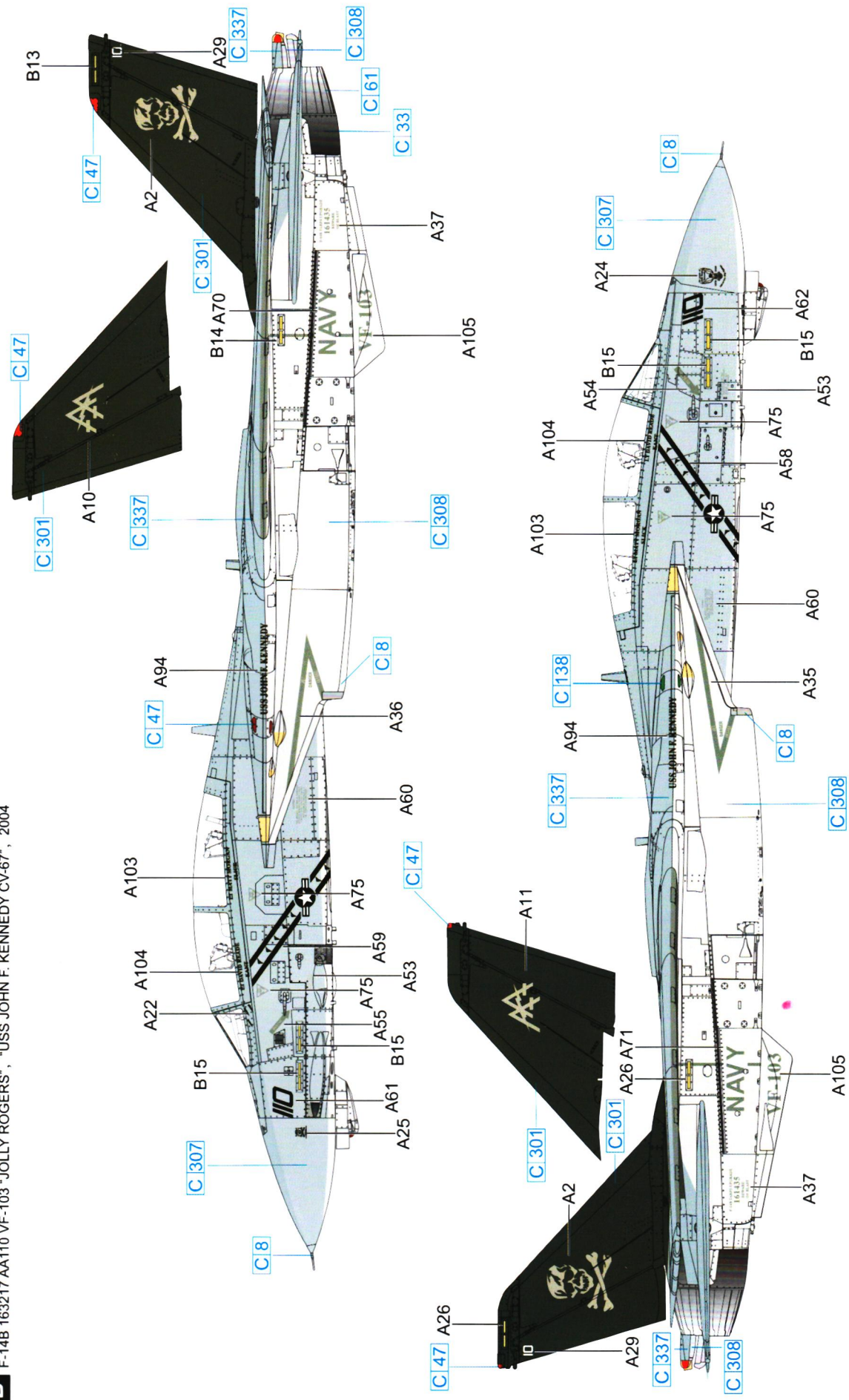

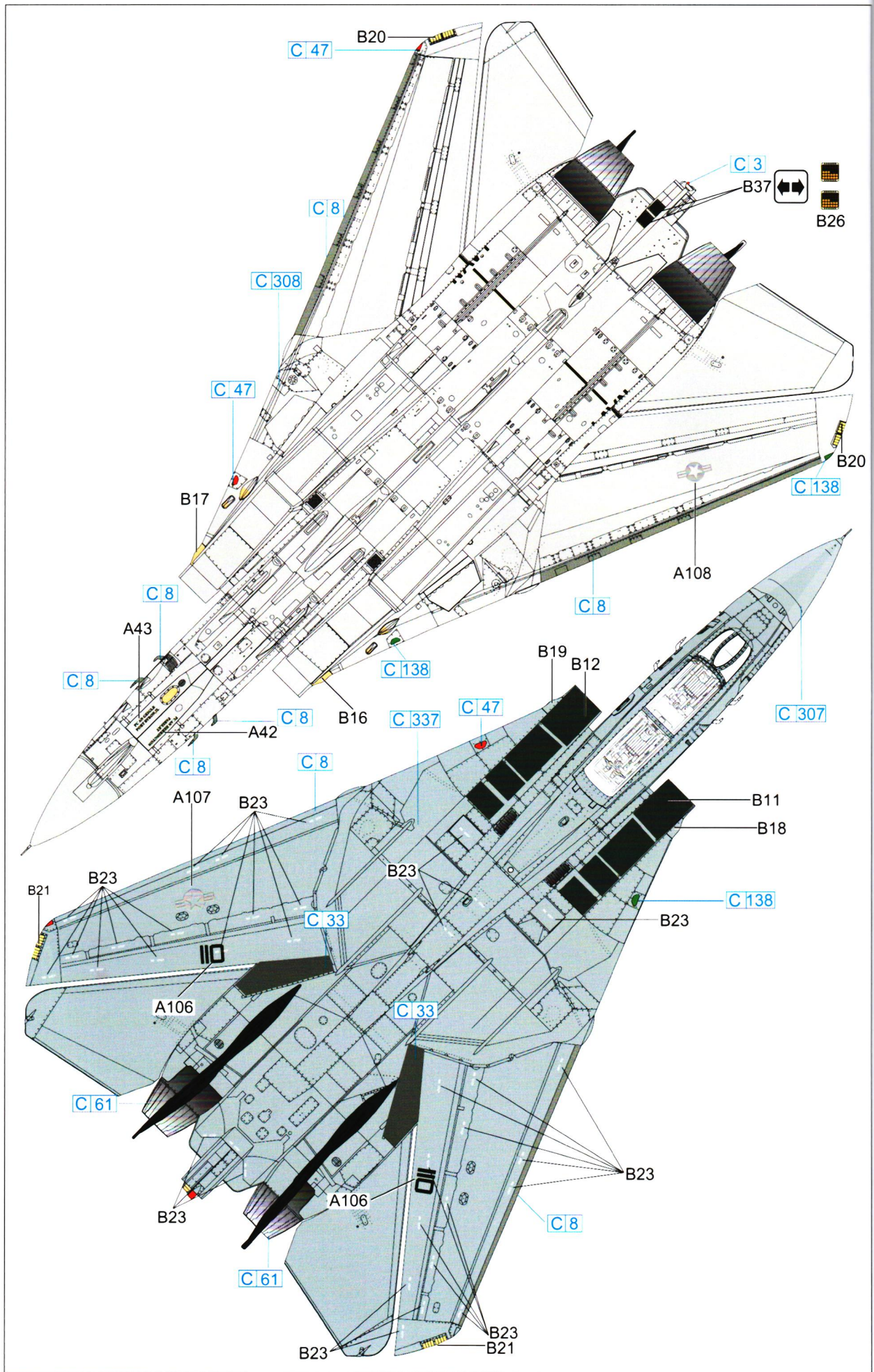

C F-14B 163225 AB102 VF-102 “钻石尾”中队, “罗斯福”号航空母舰, 2002
 F-14B 163225 AB102 VF-102 “DIAMONDBACKS”, USS THEODORE ROOSEVELT CVN-71, 2002

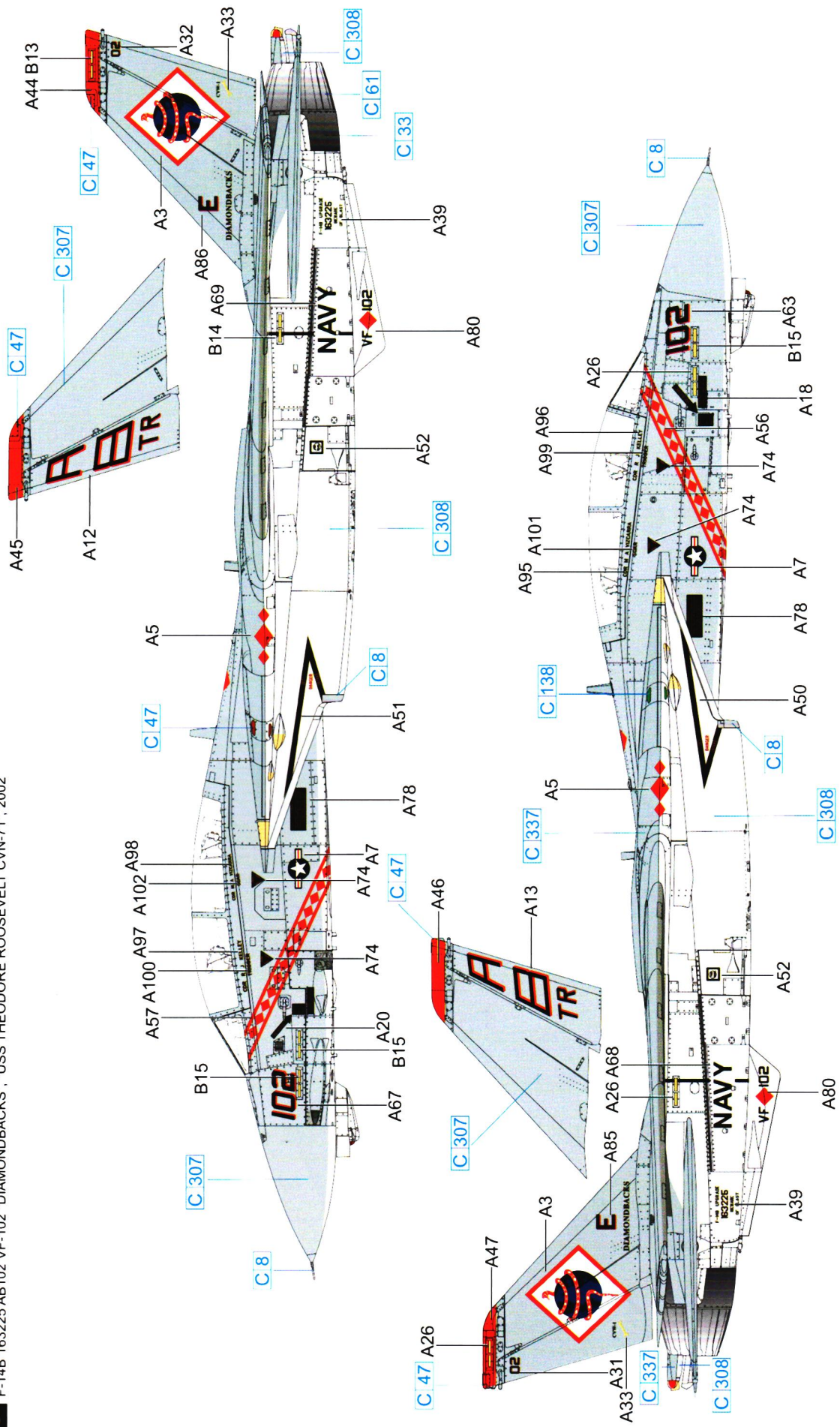

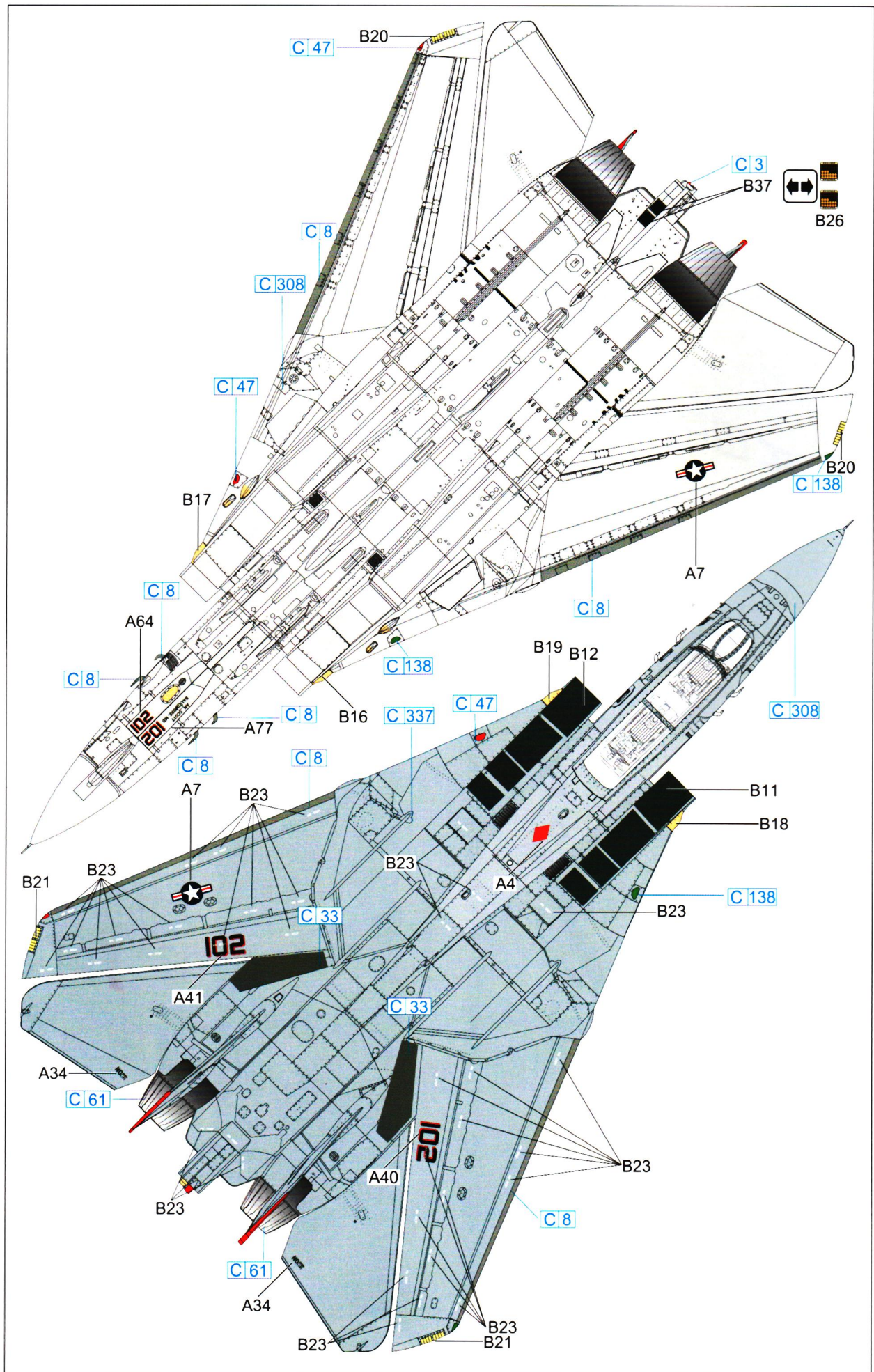

GBU-12

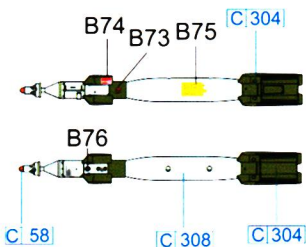

AIM-7

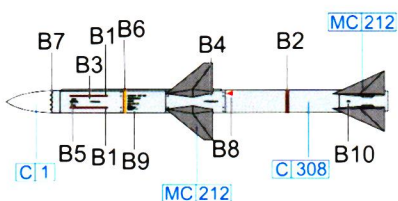

AIM-9

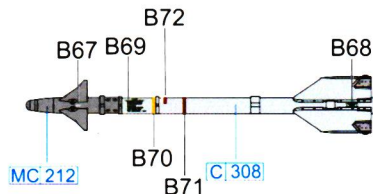

AIM-54

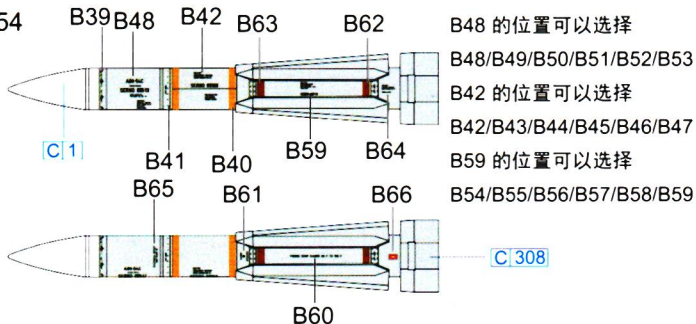

LANTIRN

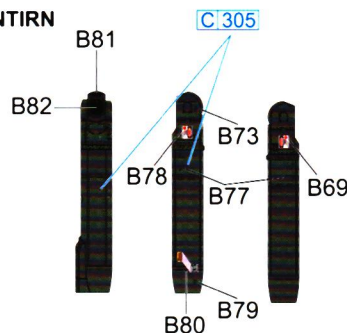

A Left TANK 左副油箱

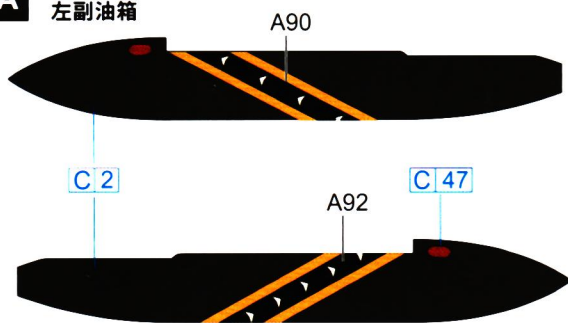

Right TANK 右副油箱

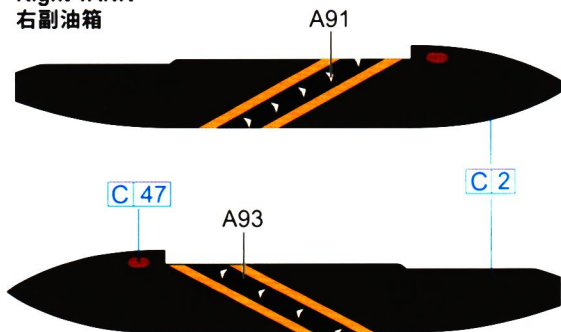

B

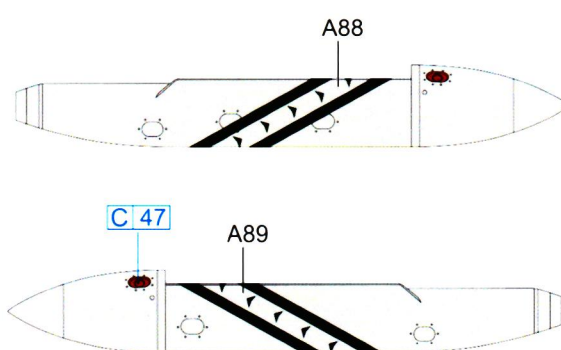
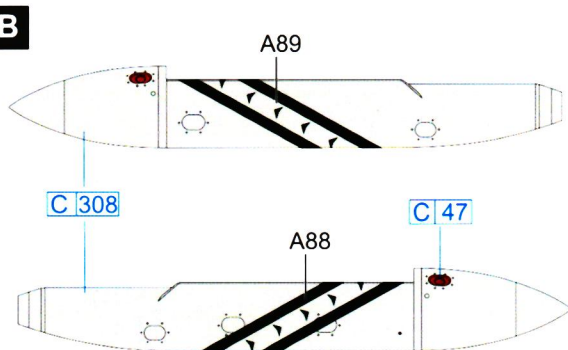

C

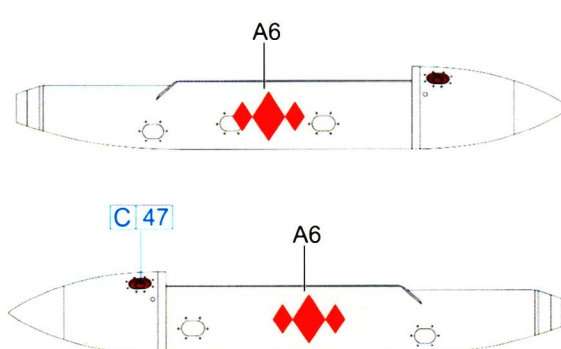
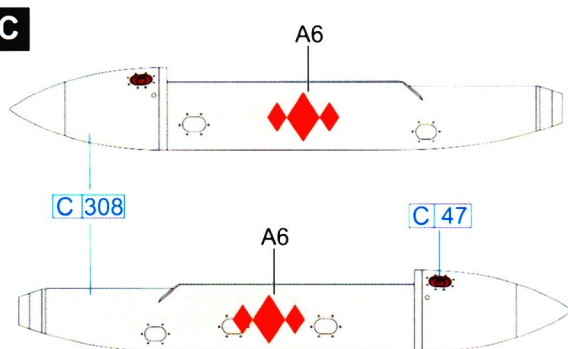

A-1 Parts x 1

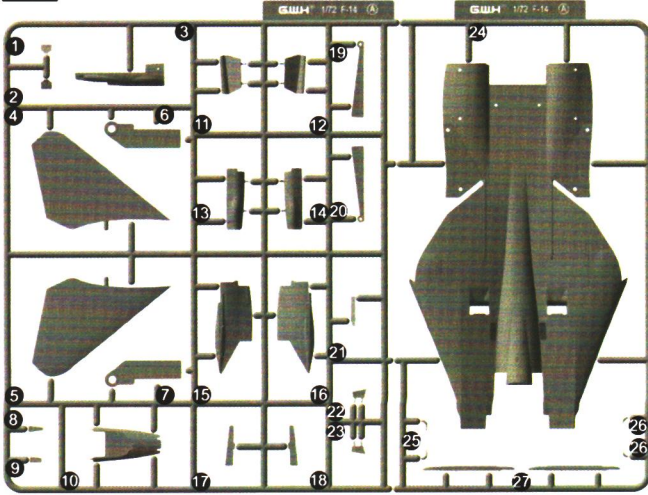

A-2 Parts x 1

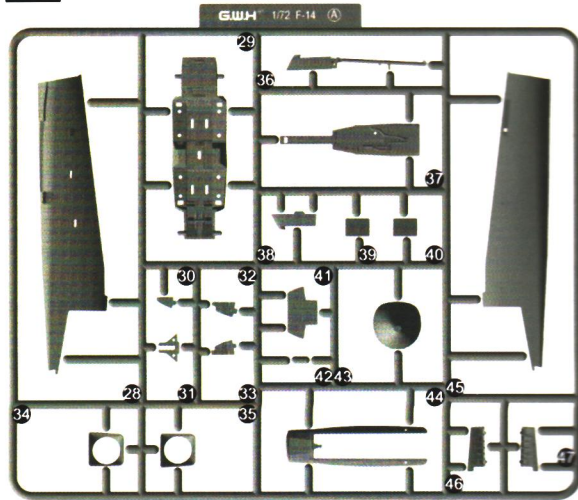

A-3 Parts x 1

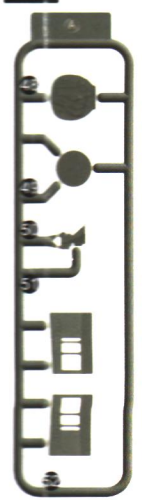

C Parts x 1

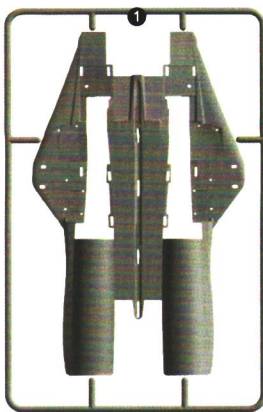

E Parts x 1

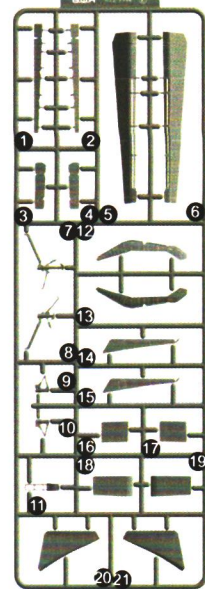

G Parts x 1

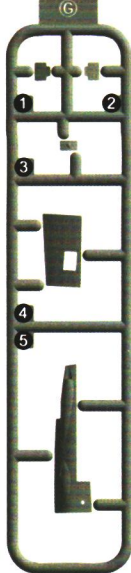

H Parts x 1



J Parts x 1

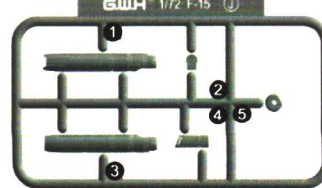

L Parts x 1



T Parts x 1

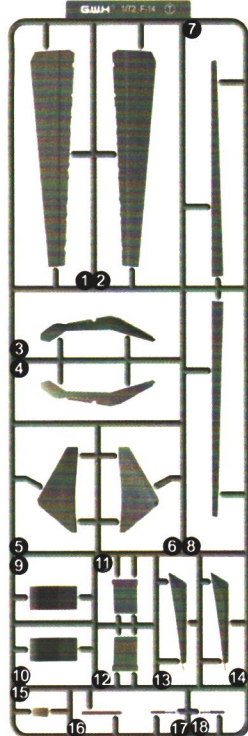

K Parts x 1

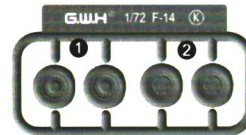

O Parts x 4

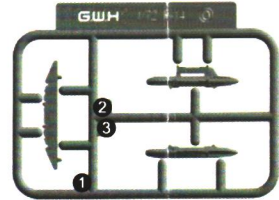

V Parts x 2

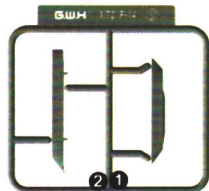

Y Parts x 1

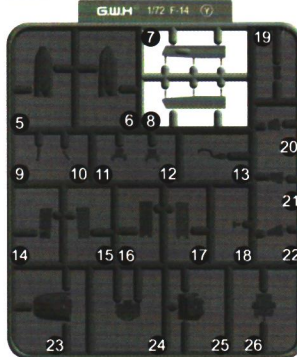

Z Parts x 2

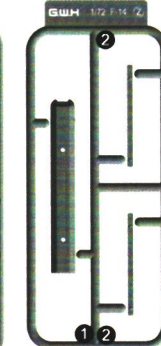

AIM-7 Parts x 1

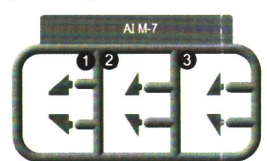

AIM-7



AIM-9 Parts x 2

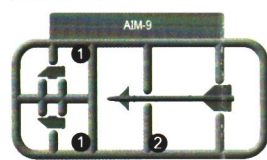

AIM-5



W Parts x 1

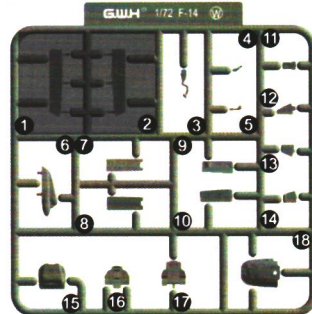

LAU-138 Parts x 1

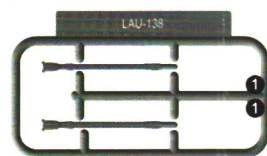

阴影零件不使用
DO NOT USE THE
SHADOW PARTS

Parts x 1 **A-4** Parts x 1 **A-5** Parts x 1 **A-6** Parts x 1 **A-7** Parts x 1 **B** Parts x 2

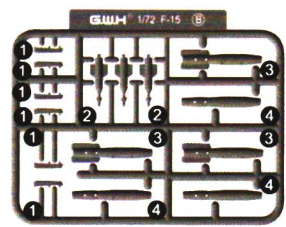
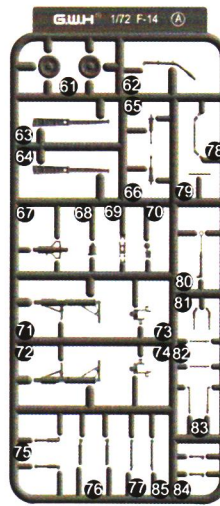
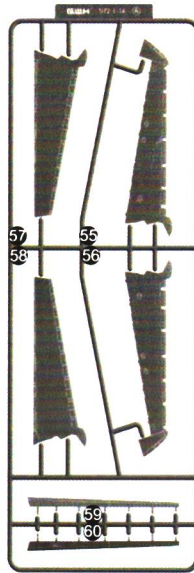

D Parts x 2

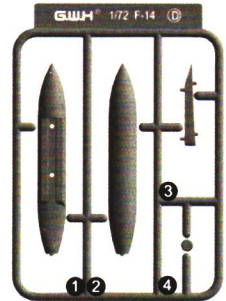

Parts x 1

M Parts x 2

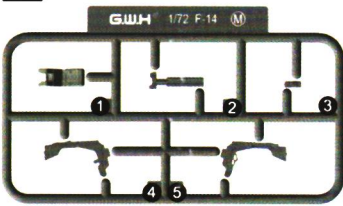

P Parts x 1

Q Parts x 1

R Parts x 2



N Parts x 1

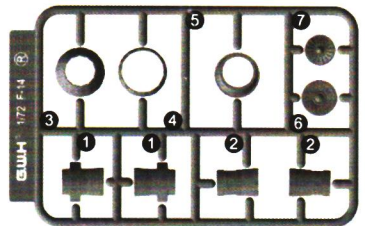
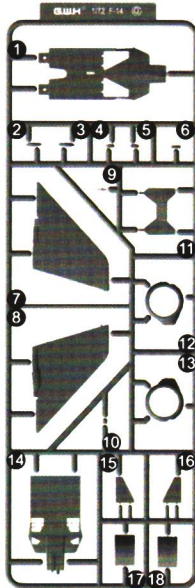
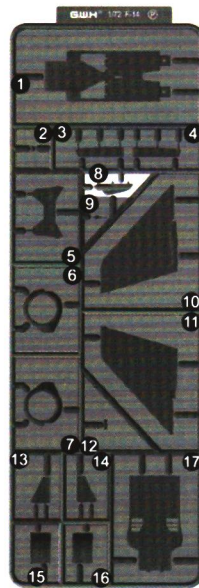

S Parts x 1

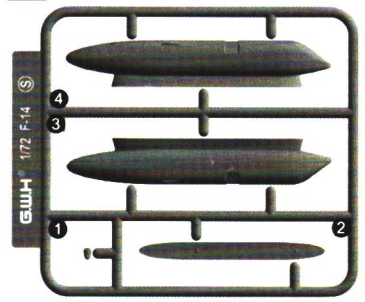

AIM-7F Parts x 1

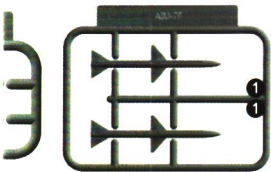

AIM-54 Parts x 1

AIM-54C Parts x 1

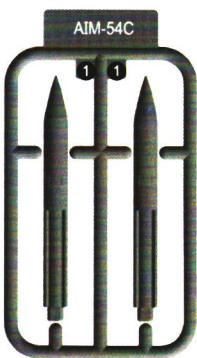
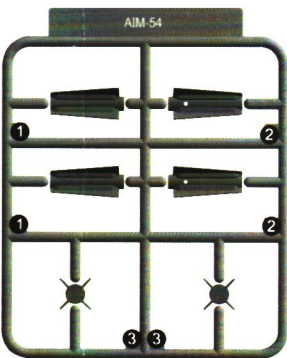
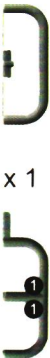

DE A

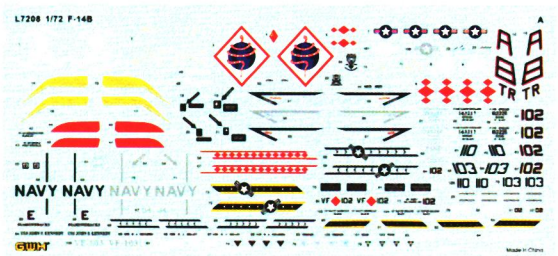

DE B

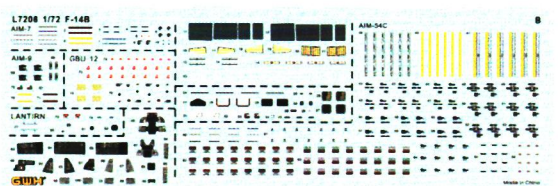

注意事項 CAUTION 組み立てのご注意

- (1) 勿于近火处使用胶水或油漆, 并打开窗户保持空气流通。
- (2) 涂料的号码请参考本栏以下的说明。本品本身不包括胶水和涂料。
- (3) 自板件中取出部件时, 应用模型专用剪, 并用介刀或小锉除去多余胶料。
- (4) 各图形的含义可参考本栏以下说明。

- (1) When you use glue or paint, do not use near a open flame, and use in a well-ventilated room.
- (2) See below for the color list. Glue and paint are not included in the kit.
- (3) When you take parts off the runner frame, use the modeling scissors and trim excess plastic with a cutter or a file.
- (4) See below for the meaning of symbols.

- (1) 接着剤や塗料は火の近くで使わないで下さい、使用の際は換気をよくして下さい。
- (2) 塗料指定のは下記のとおりです、接着剤や塗料は入っていませんので別に求めて下さい。
- (3) 部品のランナーから切り離す時は模型用ハサミ等を使い、余分な部分はカッターやヤスリ等で仕上げして下さい。
- (4) 組立図のサインマークは下の説明を御覧下さい。

图形含义 CAUTION マーク

 填平 FILL HOLE 穴を埋めて下さい	 水印粘紙 APPLY DECAL デカールを貼って下さい	 切除 CUT OFF 切り取って下さい	 弯折 BEND 折り曲げて下さい	 制作两组 MAKE TWO SET 2個作って下さい	 另一側相同制作 DO THE SAME ON THE OPPOSITE 反対側も取り付けます
 胶水 CEMENT 接着して下さい	 钻孔 OPEN HOLE 穴を開けて下さい	 选择使用 OPTIONAL どちらを選んで下さい	 不用胶水 NO CEMENT 接着しないで下さい	 注意 BE CAREFUL 注意して下さい	 瞬间胶 INSTANT GLUE FOR METAL 瞬間接着剤 (金属用)

所使用工具 RECOMMENDED TOOLS 専用工具

 塑胶件用模型胶水 Cement プラスチック用接着剤	 模型用剪钳 Side cutters 模型用ニッパー	 模型用镊子 Tweezers ピンセット
 模型用瞬间胶水 Instant Cement 瞬間接着剤	 模型用刻刀 Modeling knife 模型用ナイフ	 模型用锉刀 Diamond file 模型用ヤスリ

水贴纸使用说明 DECAL APPLICATION スライドマークの貼り方

- | | | |
|--|--|---|
| <ol style="list-style-type: none"> (1) 用模型剪刀或刻刀切下所需的图案部分。 (2) 将水贴纸浸泡在温水中10秒左右取出放置于戏水的干布上。 (3) 手拿着水贴纸基的一角, 用模型镊子小心文住浮起的水贴图案移至模型表面准确位置。 (4) 用手指适当沾水均匀涂于水贴图案表面, 使其延展移动至精确位置。 (5) 用柔软吸水的干布将水贴图案中的气泡向一边挤出, 使水贴在模型表面保持平整。 | <ol style="list-style-type: none"> (1) Cut off decal from sheet. (2) Dip the decal in tepid water for about 10 sec. and place on a clean cloth. (3) Hold the backing sheet edge and slide decal onto the model. (4) Move decal into position by wetting decal with finger. (5) Press decal down gently with a soft cloth until excess water and air bubbles are gone. | <ol style="list-style-type: none"> (1) 貼りたいマークをハサミで切り抜きます。 (2) マークをめるま湯に10秒ほど浸してからタオル等の布の上に置きます。 (3) 台紙のはしを手で持ち、貼るところにマークをスライドさせてモデルに移して下さい。 (4) 指に少し水を付けてマークを濡らしてながら、正しい位置にずらしします。 (5) 柔らかな布でマークの内側の気泡を押し出しながら、押しつけるようにして水分をとります。 |
|--|--|---|

蚀刻片使用说明 PHOTO-ETCHED PARTS エッチングパーツ

- | | | |
|--|--|--|
| <ol style="list-style-type: none"> (1) 使用蚀刻片专用剪刀或模型专用刻刀将蚀刻片零件切割下待用。 (2) 切割下的零件上有蚀刻片的残留连接点部分, 使用模型专用锉刀细心打模干净。 (3) 蚀刻片部分在涂装之前必须使用专用的模型金属底漆打底。 <p>注意事项: 蚀刻片很薄外延较为尖锐, 有刮手的可能, 在使用之时请务必小心。</p> | <ol style="list-style-type: none"> (1) Cut off photo-etched parts using a modeling knife. (2) Carefully remove any excess using a file. (3) Apply metal primer prior to painting. <p>Attention, please: Extra care should be taken to avoid personal injury when handling photo-etched parts.</p> | <ol style="list-style-type: none"> (1) 切り離す時はカッターナイフを使用してパーツを切り離します。 (2) 切り出した時、部品に出張った部品が残っている場合は、ヤスリなどで丁寧に削り落とします。 (3) 塗装が必要なパーツは下地にメタルプライマーを吹き着けてから塗装します。 <p>ご注意 エッチングパーツは大変薄く、手などを切り恐れがあります。取扱いには十分注意して下さい。</p> |
|--|--|--|

涂装色表 PAINT REQUIRED カラー番号リスト

■ [C000] GSI CREOS Mr.COLOR				■ [00-000] ACRYLICOS VALLEJO				■ FS00000 联邦色号			
[C2]	A.MIG 0032	黑色	Black	[C61]	A.MIG 0046	消铁色	Burnt Iron				
[C8]	A.MIG 212	银色	Silver	[C301]		深灰色 FS36081	Gray FS36081				
[C25]	A.MIG 0277	深海灰	Dark Sea Gray	[C304]		橄榄褐 FS34087	Olive Drab FS34087				
[C33]	A.MIG 0046	消光黑	Flat Black	[C305]		灰色 FS36118	Gray FS36118				
[C47]		透明红	Clear Red	[C307]	A.MIG 0208	灰色 FS36320	Gray FS36320				
[C50]		透明蓝	Clear Blue	[C308]		灰色 FS36375	Gray FS36375				
[C55]	A.MIG 088	卡其色	Khaki	[C315]		浅灰色 FS16440	Light Gray FS16440				
[C58]		黄橙色	Orange Yellow	[C316]	A.MIG 0047	白色 FS17875	White FS17875				
[C317]		灰色 FS36231	Gray FS36231								
[C327]	A.MIG 0049	红色 FS11136	Red FS11136								
[C329]	A.MIG 0048	黄色 FS13538	Yellow FS13538								
[C337]		灰蓝色 FS35237	Gray Blue FS35237								