

Colours & Markings

1 Ha-1112M-1L Buchón, 364047, 364.Escuadrón, El Aauin Air Base, Spanish Sahara, 1963.

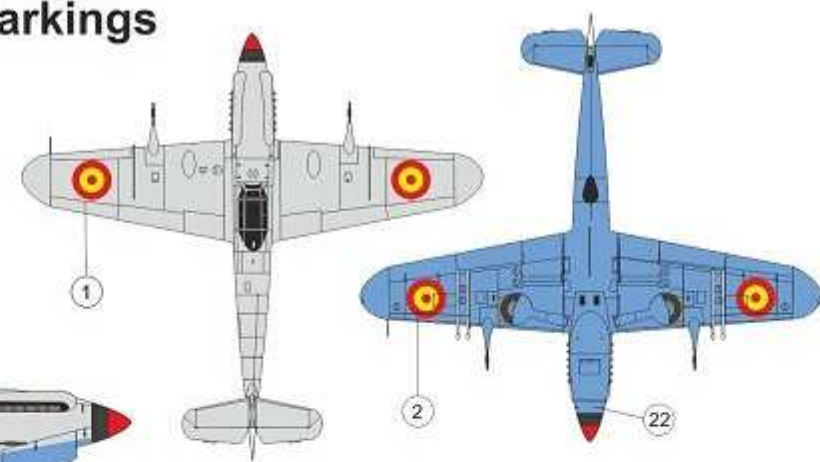

2 Ha-1112M-1L Buchón, 471023, Museo del Aire, Madrid, Spain 1960-1965.

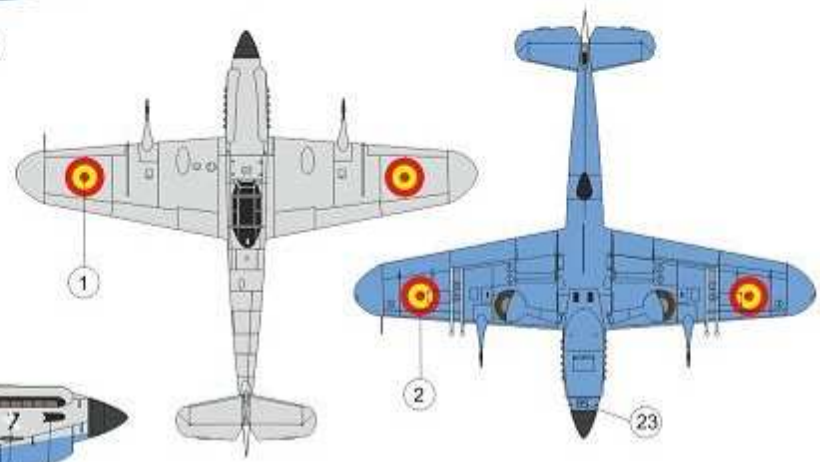

3 Ha-1112M-1L Buchón, 7015, 364. Escuadrón, Gando airfield, Grand Canaria, Spain.

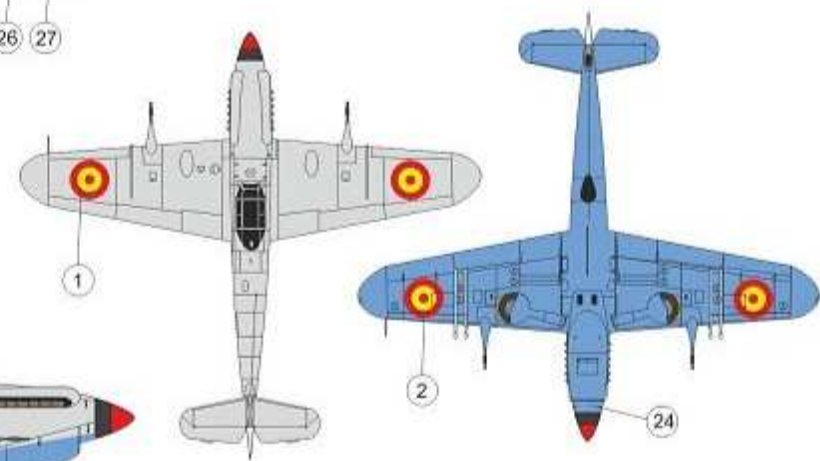

Paints used:
HUMBROL

56	109	19	34	33
Aluminium	Azure Blue	Red	White	Black

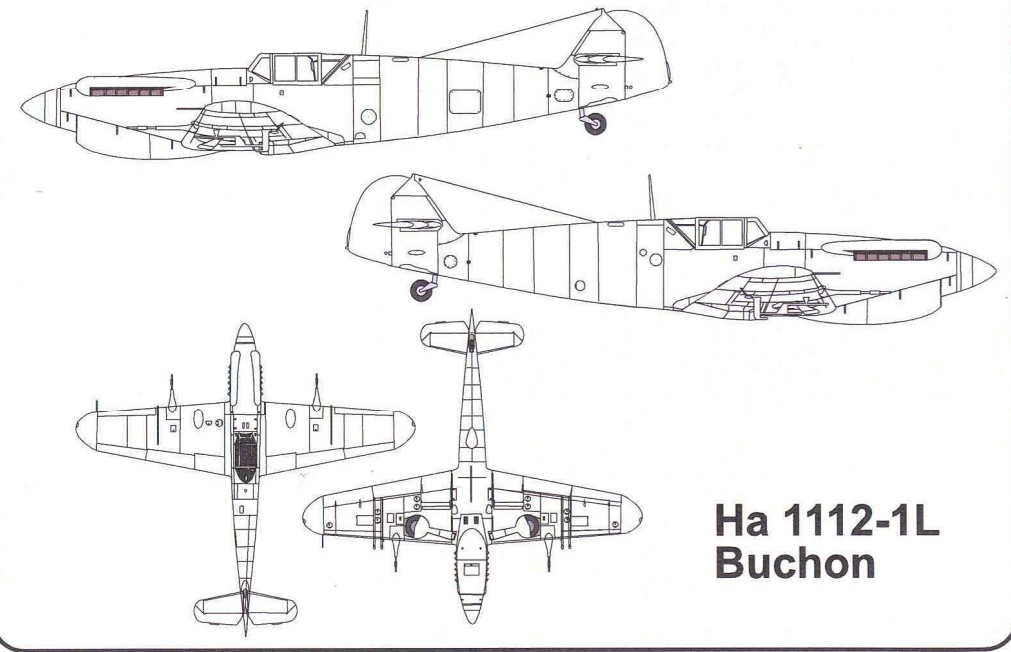
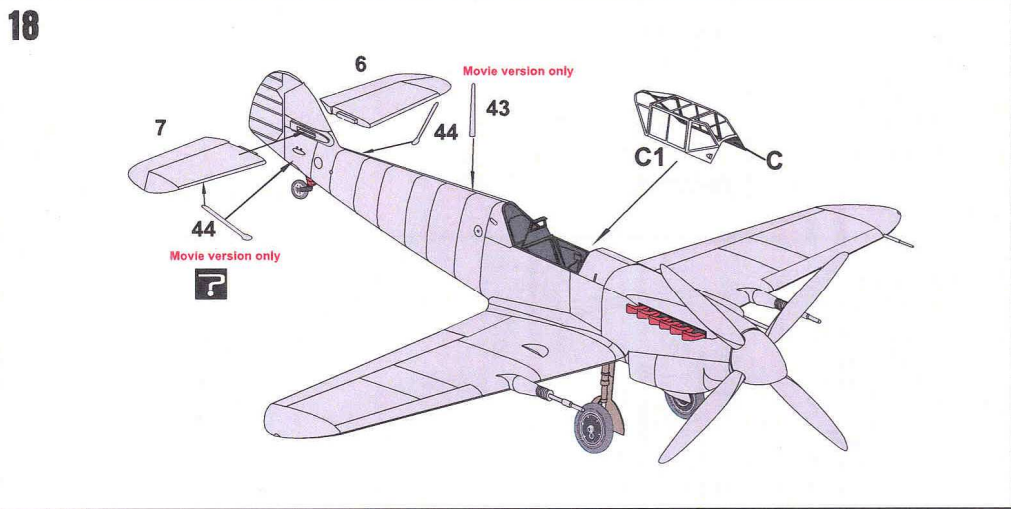
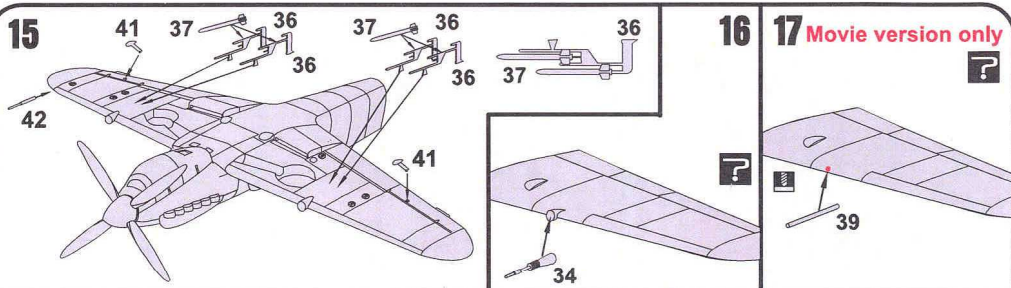

AZ model
Plastic kits

Plastic model
scale 1/72

Ha-1112-1L Buchon

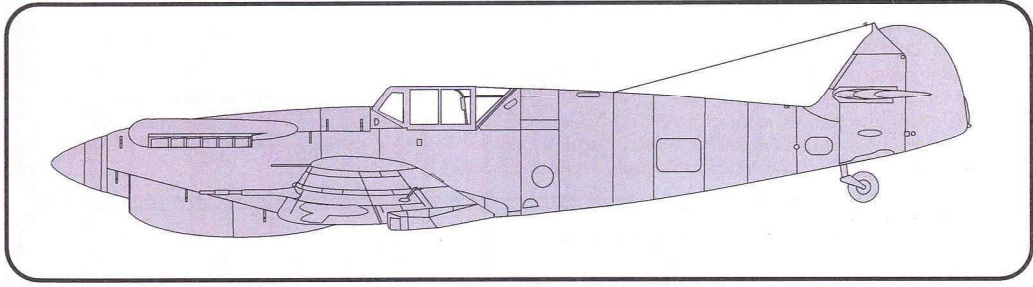

History in brief

The Hispano Aviación HA-1109 and HA-1112 are licence-built versions of the Messerschmitt Bf 109G-2 developed in Spain during and after World War II.

The final variant was the HA-1112-M1L Buchón (Pouter), which is a male dove in Spanish. It first flew on 29 March 1954 with a 1,600 hp Rolls-Royce Merlin 500-45[4] engine and Rotol propeller, both purchased as surplus from the UK. This engine had a chin intake, that altered the lines of the Bf 109's airframe. It was an improvised assembly of outdated components but this was appropriate for the intended purpose of controlling Spanish colonial territories in Africa, where more sophisticated technology was both unnecessary and unavailable in isolated Spain at the time. It carried two 20 mm Hispano-Suiza 404/408 cannons and two Oerlikon or Pilatus eight-packs of 80 mm rockets and remained in service until 27 December 1965.

Due to their longevity, Buchóns have appeared in several war films masquerading as Bf 109Es and Gs, in movies such as Battle of Britain (alongside CASA 2.111 bombers, a Spanish-built version of the Heinkel He 111), Der Stern von Afrika, Memphis Belle, Dunkirk, and The Tuskegee Airmen. Remarkably, Buchons also played the Bf 109's opposition, the Hawker Hurricane, in one scene in Battle of Britain.

Historie

Hispano Aviación HA-1109 a HA-1112 jsou licenčně stavěné varianty Messerschmittu Bf 109G-2 vyvinuté ve Španělsku během druhé světové války a v těsně poválečném období.

Konečnou verzí byla HA-1112-M1L Buchón, která absolvovala první let 29. března 1954. Vybavena byla motorem Rolls-Royce Merlin 500-45 a vrtulí Rotol, pocházejícími z britských válečných přebytků. Zástavba motoru se vstupem vzduchu změnila siluetu původního Bf 109G. I když se jednalo o kombinaci zastaralých komponentů, pro účely kontroly Španělskem ovládaných území v Africe byla dostačující. Výzbroj tvořily kanony Hispano-Suiza 404/408 ráže 20mm a raketové bloky Oerlikon nebo Pilatus pod křídly. Buchony setrvaly ve službě až do 27. prosince 1965. Španělské Buchony si zahrály německé stíhačky v mnoha filmech, například Battle of Britain, Der Stern von Afrika, Memphis Belle, Dunkirk a The Tuskegee Airmen.

Symbols/Symboly

Drill hole Vývrtat	Cyanocrylate Vteřinové lepidlo	Remove Odstranit	Reduce Zbrousit	Make new Vyrobit	Option Volba	Bend Ohnout	Putty Tmel
-----------------------	-----------------------------------	---------------------	--------------------	---------------------	-----------------	----------------	---------------

	Colour name	Humbrol	Colour name	Humbrol
A	RLM 22 Black	H33	G Aluminium	H56
B	RLM 21 White	H34	H RAL 01 Silver	H11
C	RLM 66 Black Grey	H67	I RLM 24 Blue	H25
D	Gunmetal	H53	J RLM 23 Red	H60
E	RLM 70 BlackGreen	H241	K RLM 02 Grey	H240
F	RLM 04 Yellow	H24	L RLM 26 Brown	H113

Drawings/Výkresy:
The last of the Eagles J. R. Beaman Modelář 2/2006

References/Podklady
Bf 109 in action part.2
Bf 109G/K Kagero
Aero detail 5 Bf 109G
Jagdwaaffe Bf 109
Internet

Read before you start:

- 1/ Before you begin, study carefully instructions, exploded drawings and numbering of parts.
- 2/ Prior your assembly, choose carefully your variant and remove all parts of it.
- 3/ Optional parts and their application compare with the picture on the box.
- 4/ Carefully remove parts, clean its and prior to applying adhesive, check to see whether the parts fit together.
- 5/ Assemble thoroughly, do not hurry. You will find that your finished model will reflect your time, work and patience.

Doporučení a upozornění:

- 1/ Dříve než začnete ,prostudujte stavební návod a číslování dílů.
- 2/ Před začátkem stavby zvolte verzi a pečlivě vyberte díly pro variantu, kterou chcete stavět .
- 3/ Volitelné díly/možnosti a jejich použití při stavbě konfrontujte s náhledem markingu na obalu.
- 4/ Díly opatrně oddělte z rámečků, odstraňte technologické vtoky a před slepením je řádně začistěte.
- 5/ Pracujte pečlivě, nespěchejte, dokonalý vzhled modelu záleží jen na Vás.

Plastic parts/Plastikové díly

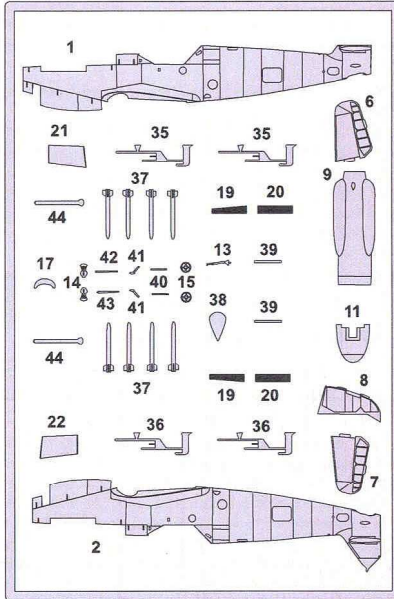
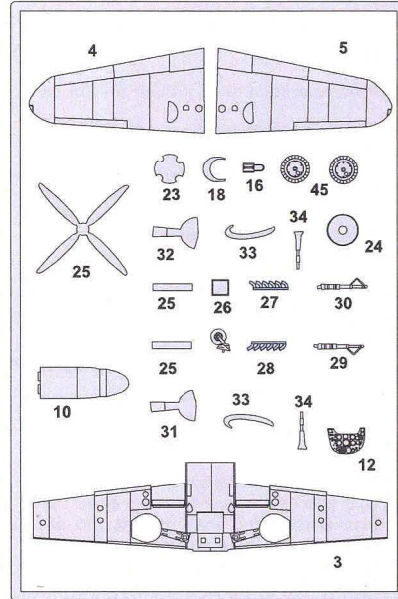

Clear parts/ Pruhledné díly

