

MIKOYAN GUREVICH MIG-17D/E FRESCO

1/72 Scale Series



HASEGAWA

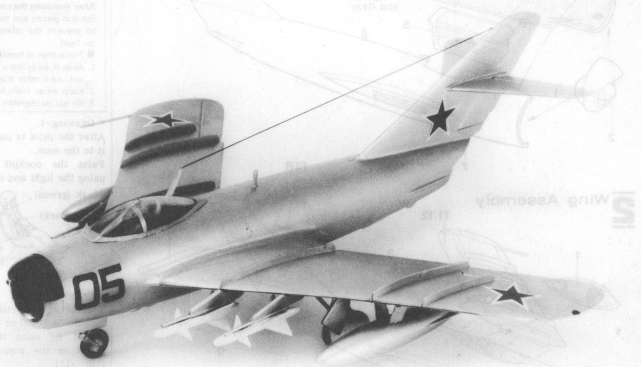

Photo of Completed Model

MIG-17 D/E

Utilizing the accumulated data during the Second World War, the famous MIG-15 was the world's first sweptback fighter plane to be perfected and became the rival to the F-86. However, due to the focus on the lightweight fuselage, it lacked the armament suitable to such a modern fighter plane. MIG-17 was developed as the successor of MIG-15. It was put into mass production from the latter part of 1952 and in 1953 it was assigned to the fighter squadrons, and subsequently advanced models were developed. They became the standard fighter planes for the Communist countries... production licensed to Czechoslovakia, Poland and Red China. Today, the countries operating the MIG-17 are USSR, Red China, Czechoslovakia, East European countries, Near East and African countries. The original MIG-15, through numerous improvements, became stable when landing and during takeoff at low speed, which fully performed to its expectation. MIG-15UTI, the widely used advanced training plane, is the evidence of the improvements. However, the high speed stability in the subsonic flight could not be solved. It was reported that there were many occasions the plane went into a spin during the tip stall, and therefore the U.S. did not give its approval due to such condition. MIG-17 was developed with the major aim in correcting the stability at high speed. The sweptback wing was increased to 45° and the wing became much thinner. The tip was extended into a bow shape and the boundary layer fence was increased to three. There is no major placement on the fuselage and tail wing in comparison to the main wing. According to the outer appearance, the back of the fuselage is somewhat extended and the overall shape of the fuselage became thinner, with the fin on the back and bottom of the fuselage and the width of the horizontal stabilizer became larger. The flap is now in one unit, divided into 2-inside and outside. Because the fuselage was extended, the back fitting on the main wing was also extended. The shape is quite different in comparison with the MIG-15 and it is fitted with one unit variation flap. MIG-17 Fresco is classified from A to E. Fresco D is the limited all weather type, the nose extended, radar dome in the middle of the air intake, and the range finder radar antenna on the top of the nose tip. The overall length of the fuselage on

this model is 0.6m (12.2m longer than the A, B, C Models.) Since the cockpit is equipped with Scoop, the space becomes much larger, which changes the outer shape. Automatic cannon is the same as Model C. The fuselage on Fresco E is the same as Model D, and is also a limited all weather type, by removing the automatic cannon armament and replaced with four small beam radar anti-aircraft missiles, and pylon on the front of the main wing.

MIG-17 D/E Data

Engine: Klimov VK-1F / Thrust: 2,695kg. with afterburner 3,300kg. (3,450kg. on planes produced later) / Overall Width: 9.6m / Overall Length: 12.2m / Overall Height: 3.8m / Main Wing Area: 24.6m² / Dead Weight: 4,470kg. / Rate of Climb from Sea Level: 3,240m per min. / Max. Speed: Mach 0.97 / Service Ceiling: 16,700m / Cruising Range: 440nm / Armament: Model D ... 37mm cannon x 1, 23mm cannon x 2, bomb 500kg. Model E ... Automatic cannon removed and replaced with 4 missiles.

Afterburner

This is the booster to increase the jet engine thrust. The gas, passing through the turbine fins, with the remaining oxygen is returned by fuel injection. In this case there is not limitation on the fin gas compared to the gas temperature; therefore, to heat up the gas temperature the injection speed becomes higher to increase the thrust. However, by this method the fuel consumption ratio is great, and not economical for regular flight.

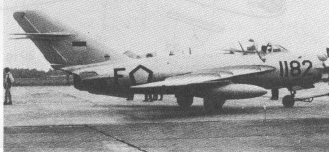
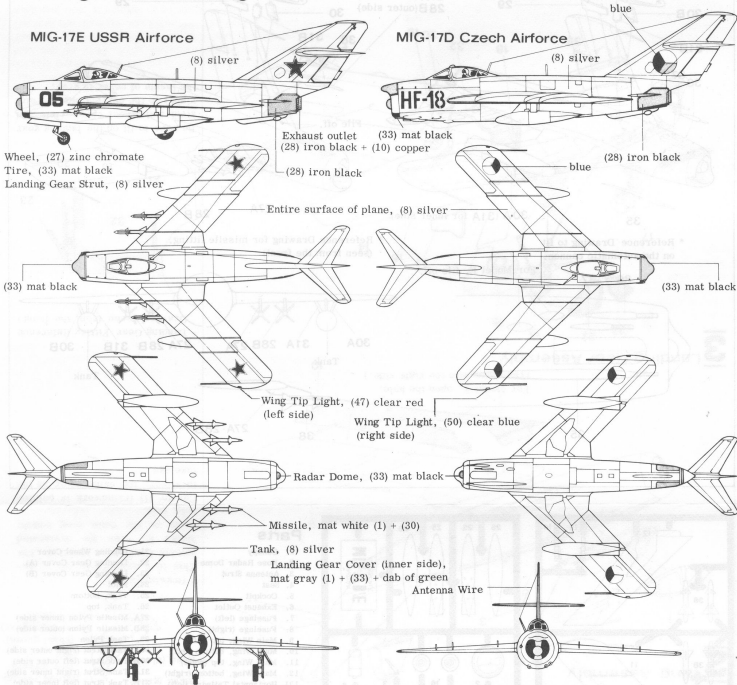

Photo offered by Aircraft News Service

Marking & Color Painting Guide



MIG-17 D/E Painting

The MIG-17 is almost colorless (original metallic surface). To remove the reflection on the nose it is painted in black or in dark green. The radar dome is painted in black or in whitish color. The rear exhaust outlet is painted in iron black and the heat resistance rime around the exhaust outlet in burnt black. The interior of the plane and the landing gear are painted in gray, and the wheel in zinc chromate. The missiles are white, but painted in red for aerobatic performance.

For the model purpose, there are two methods in your painting. No. 1, polish the surface with silver powder or silver paste to give a metallic finish. However, in this case do not touch the polished surface with the hand. To prevent the silver powder from rising, spray on the clear lacquer. No. 2 method, make a blend color of different type of silver; silver mixed with black, white yellow or blue. Then use these properly in reference with the picture of the actual plane so that the bluish part is painted in the silver with black, and the whitish part, the silver with white. Paint the interior of the plane in mat gray, the instrument panel in mat black, the head rest in dark red. Paint the landing gear hatch in mat gray. For the antenna wire, heat the plastic stem and stretch it to a thin wire, or use a nylon thread. Put the decal at the proper position after the paint is well dried.

Model Color

The numbers for the model colors are from (1) - (60). After the kit is assembled paint the necessary colors (1) white, (8) silver, (10) copper, (27) zinc chromate, (28) iron black, (30) flat base, (33) black (mat), (48) clear red, (50) clear blue, (51) flesh, (54) khaki green. To paint a wide area, use a flat brush; for pilots and other small parts use a thin brush. After the painting, be sure to wash the paint brush in paint thinner.

Applying Decals

1. Wipe and clean the area, where the decal is to be positioned, from dust or oiliness with a wet cloth.
2. Cut out the decal and remove the film covering.
3. Place in lukewarm water, transfer the decal when the paper becomes flat.
4. Slide off the decal from the paper and position it at the proper place.
5. Press the transferred decal with a soft cloth, to adhere to the model and to remove the excess moisture.
6. Do not touch the transferred decal until it is well dried.

1 Fuselage Assembly

Cement the assembled cockpit to the fuselage (right) and cement the fuselage (left) together.

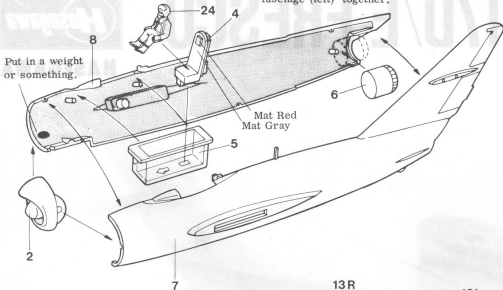

Read This before Assembly

- * Carefully read the instructions before assembling your model, and follow the instructions.
- * Carefully cut off the parts from the stem with a knife or clipper.

Model Color

The model colors are from (1) - (60). After the model is assembled, be sure to paint it.

Note:

After removing the parts from the bag, cut it in pieces and throw it away to prevent the infant from covering its head.

- Precaution in handling the adhesive.
- 1. Keep it away from infants, and do not use it other than for cementing.
- 2. Keep away from fire.
- 3. Do not deliberately inhale it.

* Drawing-1

After the pilot is painted, cement it to the seat.

Paint the cockpit by properly using the light and dark gray.

- Mask (green)
- Hose (black)
- Helmet (white)
- Belt (green)
- Suit (khaki green)
- Glove (light gray)
- Boots (black)

* Drawing-2

This is a convertible kit to assemble Model D or Model E. For Model E, open the designated holes on the main wing bottom (10), (11).

Canopy (1) framework is painted in silver, the same color as the fuselage.

2 Wing Assembly

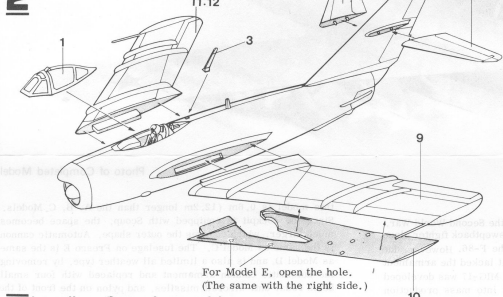

3 Landing Gear Assembly

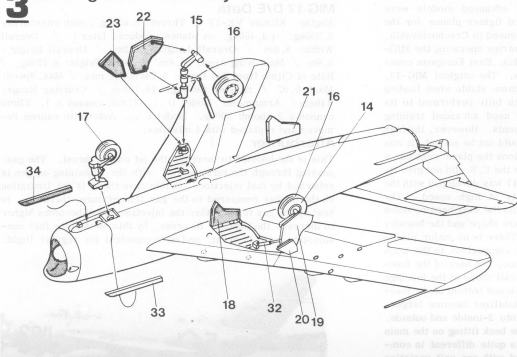

* Landing Gear Fitting Reference Drawing (seen from the front)

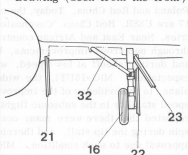

Be sure to fit on the landing gear strut and wheel cover (left and right) on the correct side. Paint the inside of cover in gray.

4 Parts Fitting

Model D

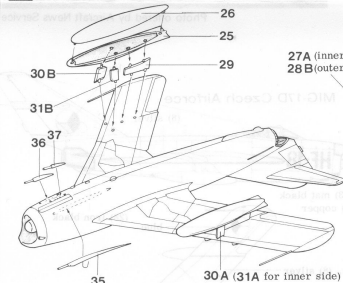

* Reference Drawing to fit on the automatic cannon.

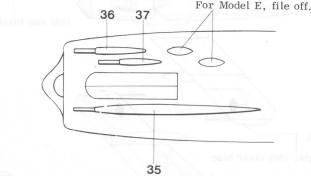

Model E

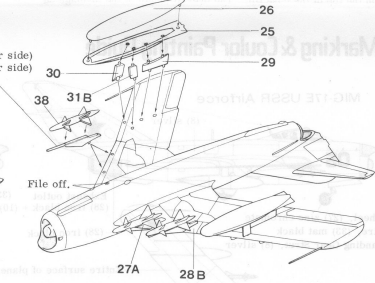

* Reference Drawing for missile fitting. (seen from the front)

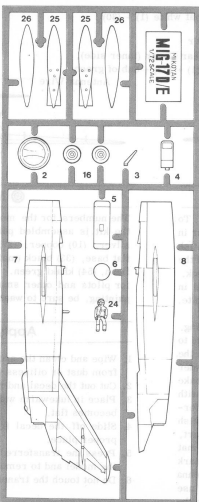
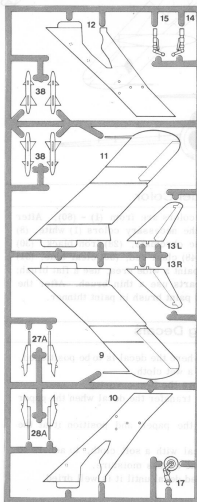
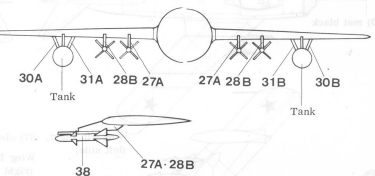

Parts

1. Canopy
2. Nose Radar Dome
3. Antenna Strut
4. Seat
5. Cockpit
6. Exhaust Outlet
7. Fuselage (left)
8. Fuselage (right)
9. Main Wing, top (left)
10. Main Wing, bottom (left)
11. Main Wing, top (right)
12. Main Wing, bottom (right)
- 13L. Horizontal Tailwing (left)
- 13R. Horizontal Tailwing (right)
14. Landing Gear Strut (right)
15. Landing Gear Strut (left)
16. Landing Wheel
17. Nose Wheel
18. Landing Wheel Cover
19. Landing Gear Cover (A)
20. Landing Gear Cover (B)
21. Landing Wheel Cover
22. Landing Gear Cover (A)
23. Landing Gear Cover (B)
24. Pilot
25. Tank, bottom
26. Tank, top
- 27A. Missile Pylon (inner side)
- 28B. Missile Pylon (outer side)
29. Tank Pylon
- 30A. Tank Strut (right outer side)
- 30B. Tank Strut (left outer side)
- 31A. Tank Strut (right inner side)
- 31B. Tank Strut (left inner side)
32. Landing Gear Strut
33. Nose Wheel Cover (left)
34. Nose Wheel Cover (right)
35. Automatic Cannon (A)
36. Automatic Cannon (B)
37. Automatic Cannon (C)
38. Missile

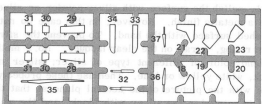

MIKOYAN GUREVICH MIG-17D/E FRESCO Marking & Color Painting Guide

1 MIG-17D Indonesian Air Force

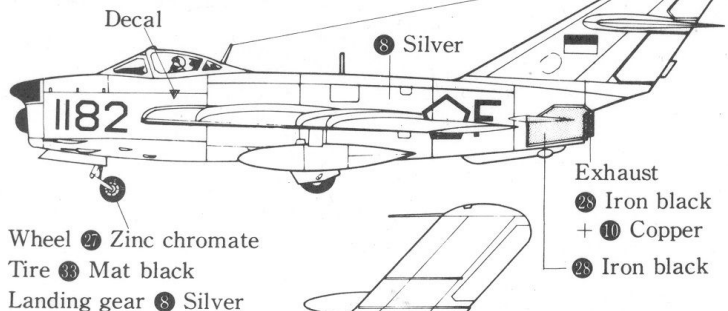

Top and Bottom view of 1

33 Mat black

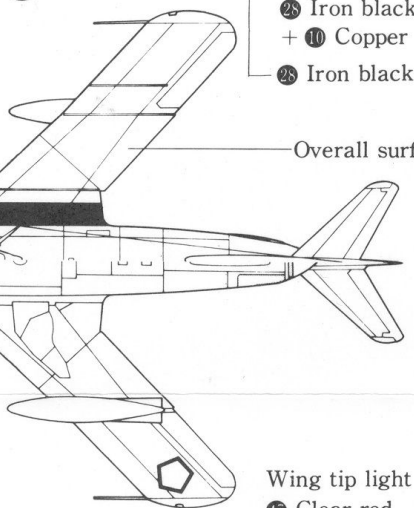

Wing tip light

47 Clear red (left)

3 MIG-17E North Viet Nam

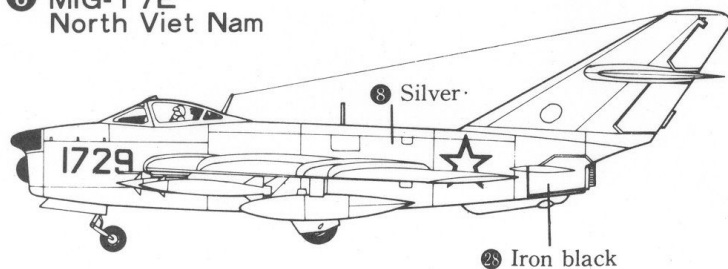

2 MIG-17D East German Air Force

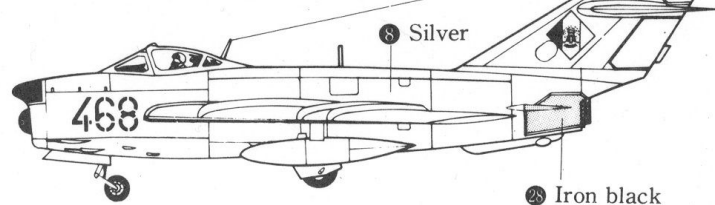

Top and Bottom view of 2

33 Mat black

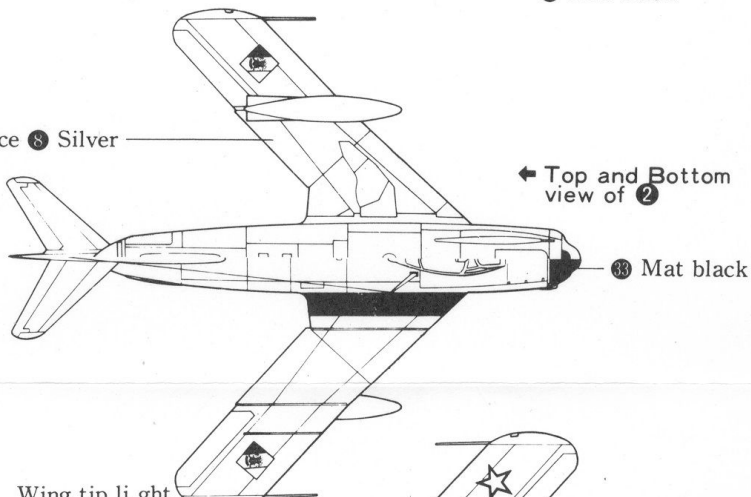

Wing tip light

50 Clear blue (right)

Top and Bottom view of 3

Radome

33 Mat black

Missile

62 Mat white

Auxiliary fuel tank

8 Silver

• Inside of landing gear cover

Mat gray 1 + 33 + 6

Antenna wire

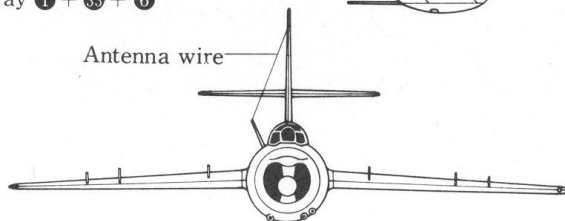
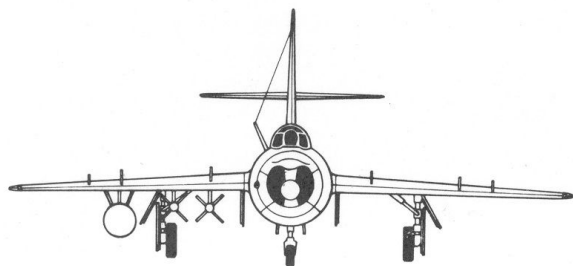

Hasegawa
C 8

1/72 スケール シリーズ
実機のイメージを比類のない高度な技術で再現するハセガワのフレッシュシリーズは手頃な大きさで種類も豊富に揃え初心者にも美しい完成が楽しめます。
MIG-17D/E
コラスコ

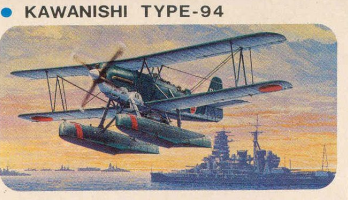
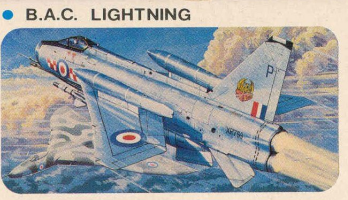
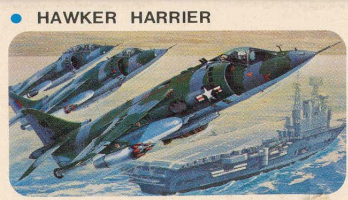

1/72 SCALE SERIES
FRESCO
MIG-17D/E
MIKOYAN/GUREVICH
U.S.S.R. FIGHTER
Hasegawa
ハセガワ
★ミグ-17について
ミグ-17はF-86Fセイバーの好敵手として名をあげたミグ-15の後継機として開発されました。高速時の安定性を強加するため、後退角を45°に増し、境界層板が増加され、ずっと薄翼になっています。
MIG-17D/E
コラスコ
ソビエト連邦共和国空軍迎撃戦闘機

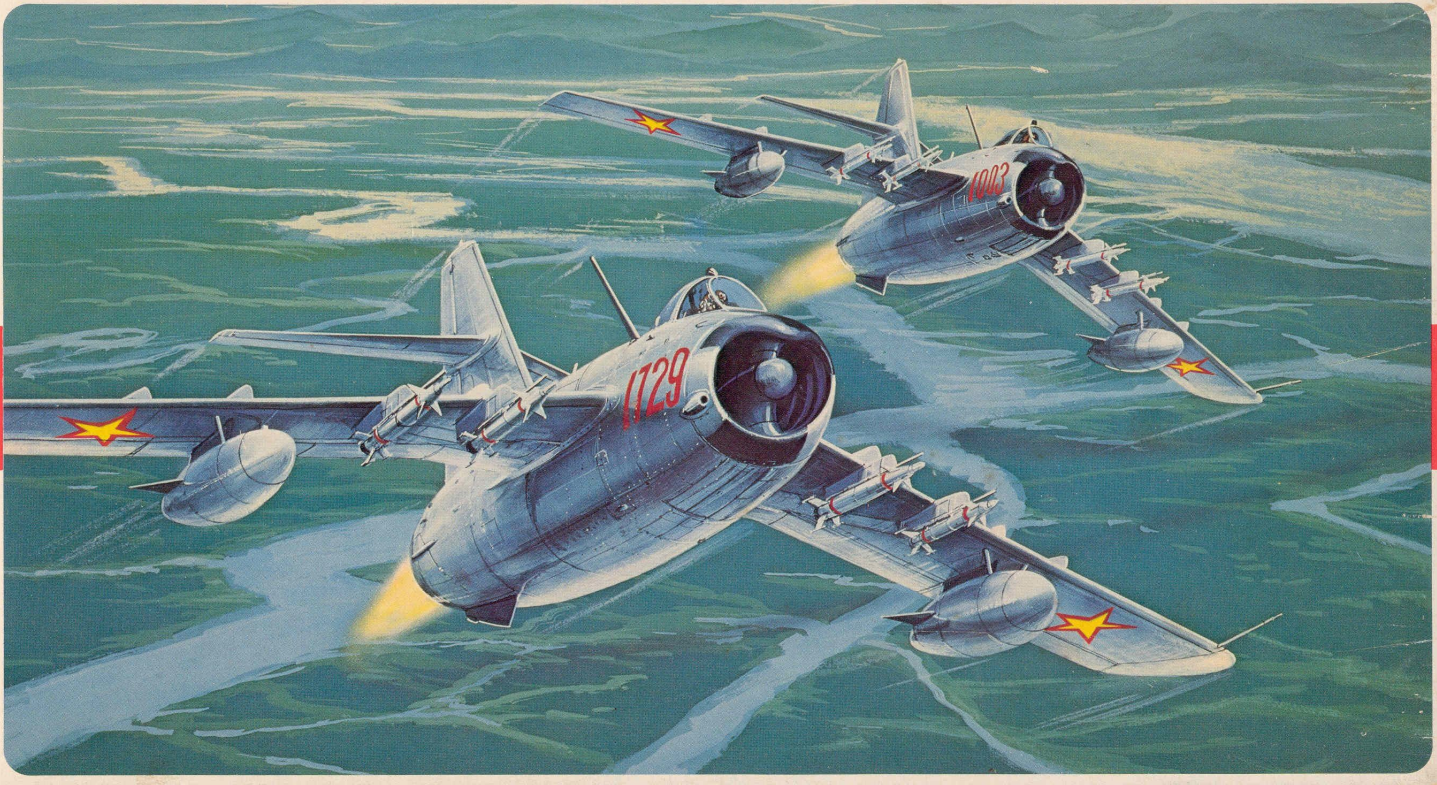

1/72 SCALE SERIES MIKOYAN/GUREVICH
MIG-17D/E
FRESCO
C 8
MANUFACTURED BY HASEGAWA SEISAKUSHO CO.,LTD. SHIZUOKA, JAPAN

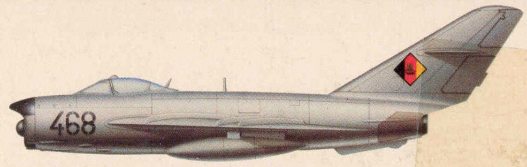

■転写マークについて
東ドイツ空軍
北ベトナム空軍
インドネシア空軍

この箱絵の塗装に使用するモデルカラーの番号です
ST J. T. A. SAFETY TOP 1167982
モデルカラー
8 33 37 62
□上段…多く必要な色 □中段…中くらい必要な色
□下段…少し必要な色



Hasegawa
C 8
U.S.S.R. FIGHTER
MIG-17D/E FRESCO
MIKOYAN/GUREVICH
1/72
MIG-17D/E
コラスコ
ソビエト連邦共和国空軍迎撃戦闘機

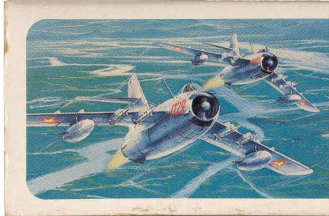

Hasegawa
C 8
ソビエト連邦共和国空軍迎撃戦闘機
MIG-17D/E コラスコ
Kit No. C008-450
1/72
MIG-17D/E
FRESCO
MIKOYAN/GUREVICH
U.S.S.R. FIGHTER