

INSTRUCTIONS FOR ASSEMBLING THE

**BATMAN'S**

**BATMOBILE™**

**POL822**

**POLAR LIGHTS®**

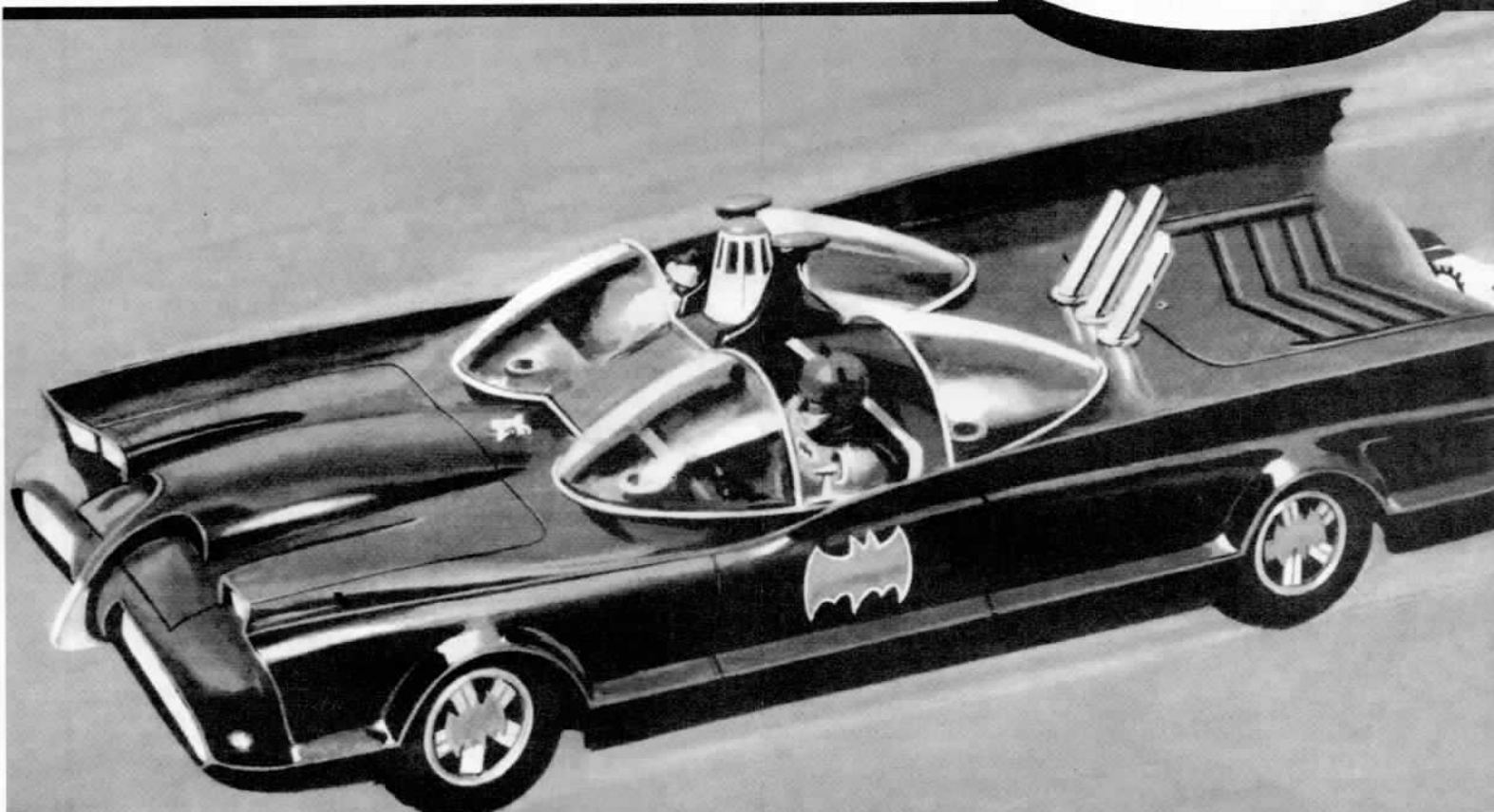

**IMPORTANT - READ THIS FIRST!**

Before assembling model, study sketch carefully. Important - Apply cement to inside surfaces only. Avoid getting cement on outer surfaces of model sections. Use cement very sparingly and avoid getting cement on hands, so as not to mar or smear plastic surfaces.

Do not hurry. Work carefully and patiently. Important Note: Before proceeding to cement parts together, it is advisable to fit parts together dry (without cement) so that you may familiarize yourself with parts and how they go together, also noting the points where cement is to be applied. For best results assemble model exactly in the order indicated.

**This kit is molded of styrene plastic—Use only styrene compatible glues, cements and high quality paints designed specifically for plastic model kits. Assure yourself of a perfect model every time!**

Batmobile design by George Barris.  
Batman and all related characters and elements are trademarks of and © DC Comics.



AMT, MPC, and POLAR LIGHTS are registered trademarks of Learning Curve Brands, Inc. used under license to Round 2, LLC. ©2010 Learning Curve Brands, Inc. All rights reserved. ©2010 Round 2, LLC, South Bend, IN 46628 USA. Product and packaging designed in the USA. Made in China.

All rights reserved.

(S10)

Mail this coupon and \$3 for your  
New **ROUND 2 MODELS FULL COLOR 16 - PAGE**  
**COLLECTOR'S CATALOGUE OF HOBBY KITS**

**ROUND 2 MODELS - CATALOG**

4073 Meghan Beeler Ct. South Bend, IN 46628

Please rush me by return mail the new 16 - page full-color ROUND 2 MODELS HOBBY KIT CATALOGUE. I am enclosing a check or money order for \$3.

NAME .....  
(PLEASE PRINT)

ADDRESS .....

CITY ..... ZIP .....

STATE .....

A photocopy of this coupon is acceptable in lieu of cutting it out. Cut Along Line

**CLASSIC**  
**REBORN**

2009 - 2010 ROUND 2 MODELS

Every effort has been made to insure the completeness of this kit — however, should any part be missing, go to this web address.

<http://www.round2models.com/replacement>

Follow the directions shown there and fill out the required information completely.



FOR SUGGESTED DETAIL PAINTING SCHEME - SEE ILLUSTRATIONS. Paint parts as indicated and allow to dry before assembling

Use only HIGH QUALITY PAINTS designed specifically for plastic model kits. ASSURE YOURSELF OF A PERFECT MODEL EVERY TIME!

# BATMAN'S BATMOBILE

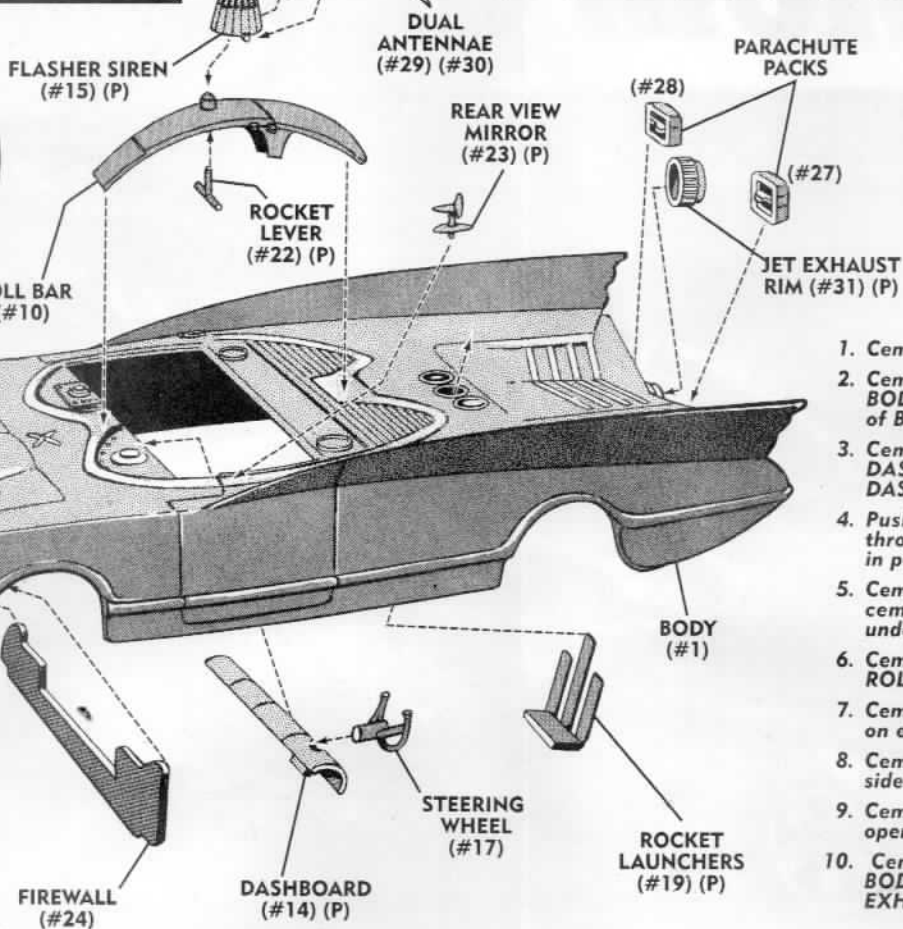
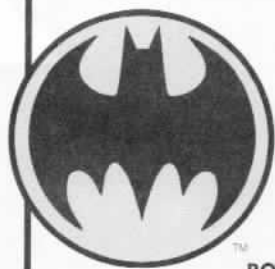

**1**

## BODY ASSEMBLY

1. Cement GRILLE to BODY.
2. Cement FIREWALL to underside of BODY. (fits between ribs near front of BODY interior).
3. Cement STEERING WHEEL to DASH BOARD, then cement DASHBOARD to BODY.
4. Push ROCKET LAUNCHERS through holes in BODY and cement in position.
5. Cement ROLL BAR to BODY, then cement ROCKET LEVER to underside of ROLL BAR.
6. Cement FLASHER SIREN to top of ROLL BAR.
7. Cement on ANTENNA to small peg on each side of FLASHER SIREN.
8. Cement REAR VIEW MIRROR to side of BODY.
9. Cement JET EXHAUST RIM over opening at rear of BODY.
10. Cement PARACHUTE PACKS to BODY (one on each side of JET EXHAUST RIM).

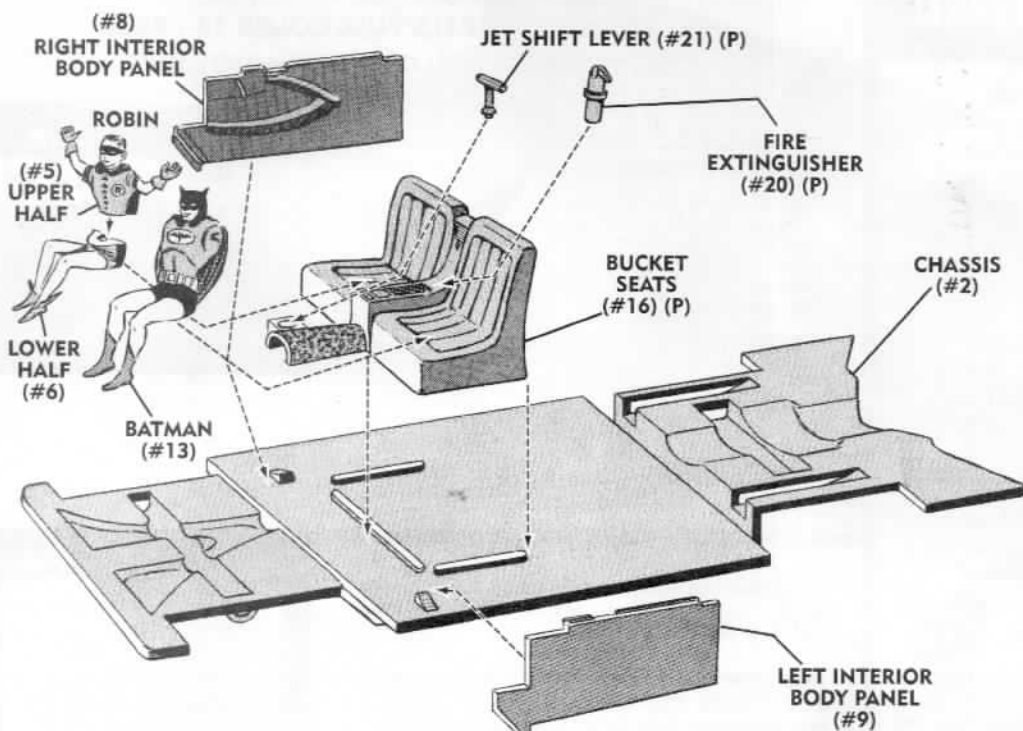

**2**

## CHASSIS ASSEMBLY

11. Cement BUCKET SEATS to CHASSIS.
12. Cement RIGHT and LEFT INTERIOR BODY PANELS against sides of BUCKET SEATS.
13. Cement JET SHIFT LEVER and FIRE EXTINGUISHER to BUCKET SEATS.
14. Cement ROBIN UPPER and LOWER HALVES together, then cement assembled ROBIN to RIGHT BUCKET SEAT.
15. Cement BATMAN to LEFT BUCKET SEAT. (NOTE: Do not cement ARMS on BATMAN until later.)

**NOTE:**  
**"P" AFTER**  
**NUMBER**  
**MEANS PLATED**

➡ Scrape metal plating from all plated parts only in the areas where they are to be cemented. Cement will not hold on plating.



LEFT FRONT WHEEL



FRONT WRAP-AROUND WINDSHIELD

REAR WRAP-AROUND WINDSHIELD

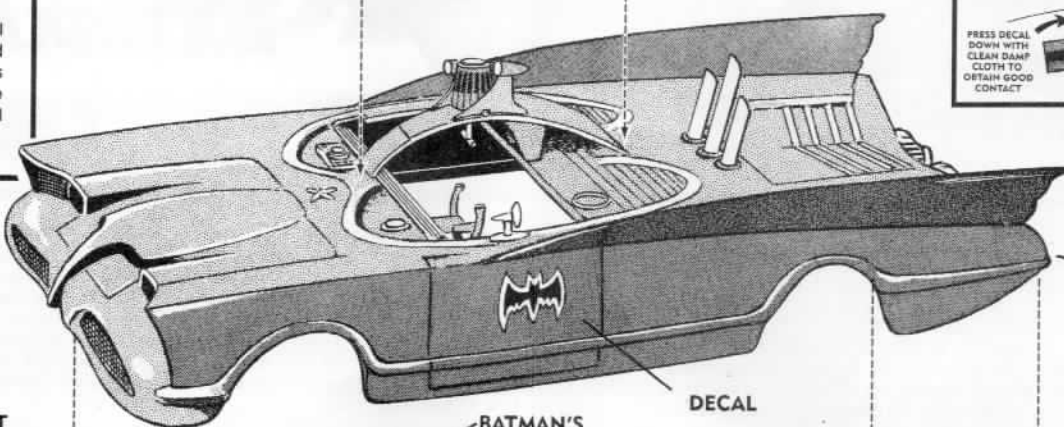

ASSEMBLED BODY BLACK WITH RED STRIPES

DECAL

BATMAN'S ARMS (#11) (#12)

RIGHT REAR WHEEL



ASSEMBLED CHASSIS

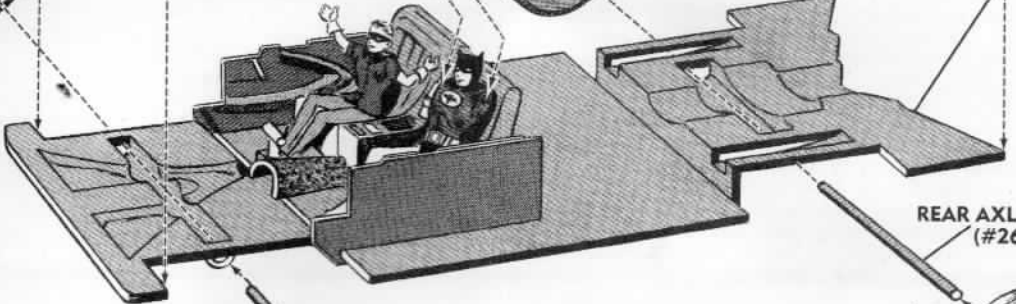

### 3 FINAL ASSEMBLY

16. Cement INNER and OUTER WHEEL HALVES together. Cement HUBCAP into ASSEMBLED WHEELS.
17. Cement an end of REAR AXLE into hole in assembled LEFT REAR WHEEL. Then push open end of REAR AXLE through AXLE HOUSING in CHASSIS and cement RIGHT REAR WHEEL to extended AXLE end. (Follow the same procedure for FRONT WHEELS.)
18. Spread sides of ASSEMBLED BODY slightly and slip down over ASSEMBLED CHASSIS. Cement in position.
19. Now cement BATMAN'S ARMS to BATMAN so that his hands will grip the STEERING WHEEL.
20. Cement FRONT and REAR WRAP-AROUND WINDSHIELDS to BODY. (ROBIN'S right hand will grip edge of WINDSHIELD.)
21. Cut out DECAL sections and apply to MODEL. Read directions on back of DECALS before applying.

#### WHEELS ASSEMBLY

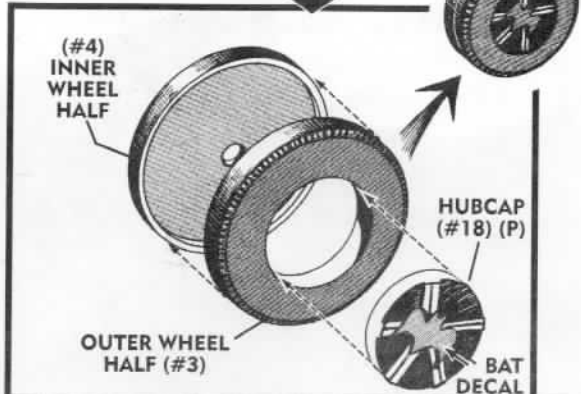

YOUR COMPLETED MODEL WILL LOOK LIKE THIS

SEE COLORING INSTRUCTIONS ON BACK OF THIS SHEET ➡



# BATMAN'S "BATMOBILE"

The mundane municipality of Gotham City, U.S.A. rests serenely on a mild, mid-summer's day. Yet behind this peaceful scene the fiendish forces of wickedness are in action plotting dastardly crimes to be perpetrated against the law-abiding citizens of this typical American city. Police Commissioner Gordon receives a warped warning from the capricious criminal plotting a mephistophelean misdeed and is put on his guard. But what can a humble police department do to thwart the devious devices of this master criminal? Will Police Commissioner Gordon and Police Chief O'Hara be able to match wits with these ingenious ingrates who take the law into their own hands and make violation of the law into a pleasure producing game? The city officials think it will be beyond their powers and resources to conquer these law breakers, yet feel secure that their super law enforcement agent will be able to thwart this polluted plot, capture the criminals, and maintain the peacefulness of Gotham City. A quick call on the Batphone will spring into action the Caped Crusader and the Boy Wonder - Batman and Robin - the best crime fighting team man has ever seen.

Meanwhile, out at the stately Wayne Mansion, the millionaire philanthropist Bruce Wayne and his ward Dick Grayson are involved in a discussion of medieval literature with Wayne's unknowing Aunt Harriet. A quiet knock on the door precedes the entrance of Alfred, the English butler, who signals to Wayne that he is wanted on the Batphone. On a subterfuge, the impetuous pair excuse themselves and hurry to answer the call. Upon learning of the predicament which faces their city, the Dynamic Duo of Daring swing into action. The button is pushed, the bookcase slides open, and the perilous pair glide down the Batpoles into the Batcave. After a quick change into their uniforms the Caped

Crusader and his young assistant jump into the Batmobile and are ready to pursue and apprehend the criminals. The nuclear turbine engine is reacted and the Batmobile streaks out of the Batcave; the road barrier falls down and the Batmobile makes the left hand turn toward Gotham City, only 14 miles away. The dedicated crime fighters reach the city in a matter of minutes because of the lightning speed of the super car, and the aid of the Batmobile. Batman and Robin are ready to thwart the diabolical plots of the law breakers.

The car Batman uses was specially designed and created for his use against the sick minds of the criminals that attack Gotham City. It is a "Velvet Bat Fuzz Black" and fluorescent cerise red painted bomb covering an atomic powered turbine engine capable of producing great speeds. It is loaded with numerous crime detection devices including the Mobile Crime Computer, the Mobile Crime Lab, the Batsonar, and the Batbeam, twin 450 watt laser beams that clear the way in emergencies. The aircraft type steering wheel contains instruments and thumb control directional signals. Twin parachutes are controlled from the cockpit when super fast stops are needed. The 10 inch Rader wheels and tires are protected by the flared wheel well protectors. The center roll bar and arch is equipped with flashing emergency and warning lights. For added protection for Batman and Boy Wonder the rear Batfins have been hand formed from bullet proof steel; while the 2 plexiglass canopies covering the cockpit, complete with ejection seats, are also bullet proof.

What all these things add up to is an amazing crime-fighting device on wheels which causes much trouble to criminals trying to escape the clutches of our noble defender of law and order. The one and only Batmobile.

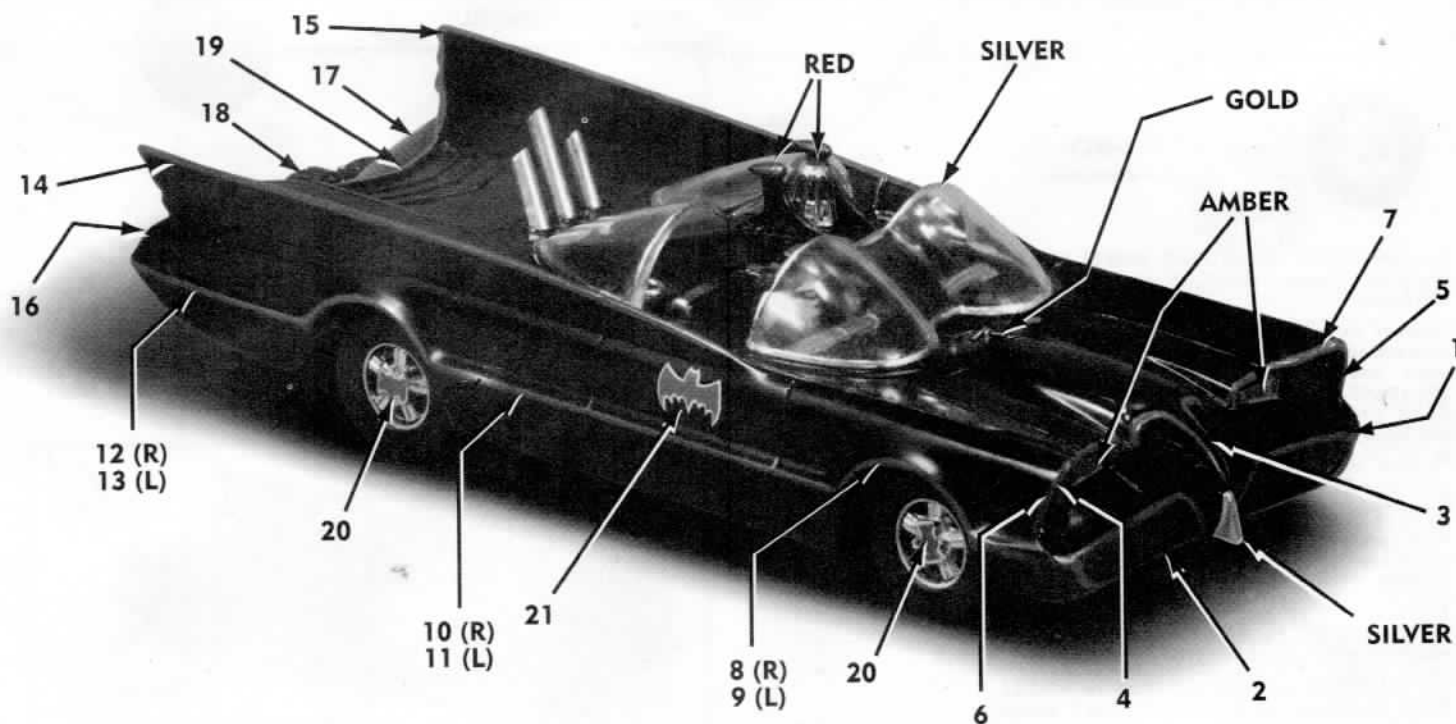

RED STRIPES MAY BE PAINTED, TAPED OR DECALED ON.  
(CHOOSE BETWEEN DECALS #4 & 5 OR DECALS #6 & 7)