

"Cut from decal sheet the section required. Place in warm water for 10-15 seconds. Slide from backing sheet directly on to model. Locate accurately and press down with soft cloth, removing excess water at same time."

In case of complaint please complete this section and send to:



Pioneer 2 Models 46 Haworth Road, Crossroads, Keighley, BD22 9DL, UK.

NAME \_\_\_\_\_

ADDRESS \_\_\_\_\_

Quoting where purchased \_\_\_\_\_

date purchased \_\_\_\_\_

missing part no \_\_\_\_\_

**1/72 SCALE**  
**SERIES 4 4003**  
**PIONEER 2**

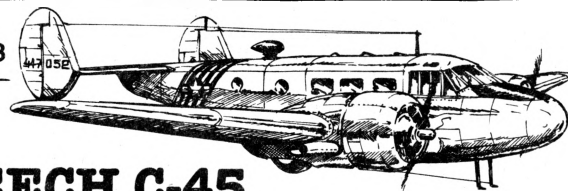

## BEECH C-45 EXPEDITOR

Twin-engined six/eight passenger low-wing Transport Monoplane

The initial Model 18A was first flown on the 15th. January 1937 and although, at the time, it seemed just another twin-engined light commercial aircraft, some 9000 aircraft were to be manufactured and even today in 1988, there are still a good many examples still flying for pleasure and profit.

The success of the Beech type 18 was created by the onset of WWII. The first US Army Air Corps order, for 11 aircraft designated C-45, came in 1940, the aircraft being used as staff transports. A follow-on order for 20 C-45A was to be the forerunner of a further 223 examples designated C-45B because of the many interior and equipment changes from the -A version.

Under Lend-Lease, the RAF obtained several of these models, calling them Expeditor I. After subsequent modifications, including a slightly longer nose (C-45F) the RAF and Royal Navy both used this aircraft as Expeditor IIs and the Royal Canadian AF designated it Expeditor III.

In January 1943, all the above classifications were to become UC-45.

In 1941, the AT-7 Navigator was produced to provide navigation training. They were equipped with three positions for students plus a dorsal astrodome. 577 examples were built and a further six, designated AT-7As, were manufactured with floats and a large ventral fin. Five AT-7s were supplied to Britain and another 549 aircraft, AT-7C, concluded the overall production.

A further Model 18 version appeared during 1941 in the advanced trainer category and was called the AT-11 Kansan. This will be featured in our present series as kit number 4009 and more comprehensive details will be found with the kit. 1582 examples of the AT series were built for the USAAF and 24 for the Netherlands.

The last wartime versions were the photo-reconnaissance aircraft F-2S and their designation was changed to RC-45A in June 1984.

The US Navy and US Marine Corps also used this Model 18 very extensively, designating their aircraft JRB-1, -2, -3, -4 but essentially identical to F-2s and C-45Bs. (The -4 was the UC-45F).



SNB-1, -2, -3 aircraft were equivalent to the AT-11, AT-7 and AT-7C respectively, whilst the Navy ambulance and photographic versions were designated SNB-2H and SNB-2P respectively. SNB-30 was an EMC aircraft.

In 1951, all the aircraft still in service with the USAF were remanufactured to zero time status and, together with further improvements, they became C-45Gs and C-45Hs.

Specifications:

Span : 14.5m (47' 8")  
Length : 10.4m (34' 3")  
Height : 2.8m (9' 9")

Weight Empty 2460 kgs (5420lbs)  
Weight Loaded 3405 kgs (7500lbs)  
Max. speed 360 kph (225mph)  
Service ceiling 7930m (26000')

		
DO NOT GLUE	GLUE	OPTIONAL CHOICE

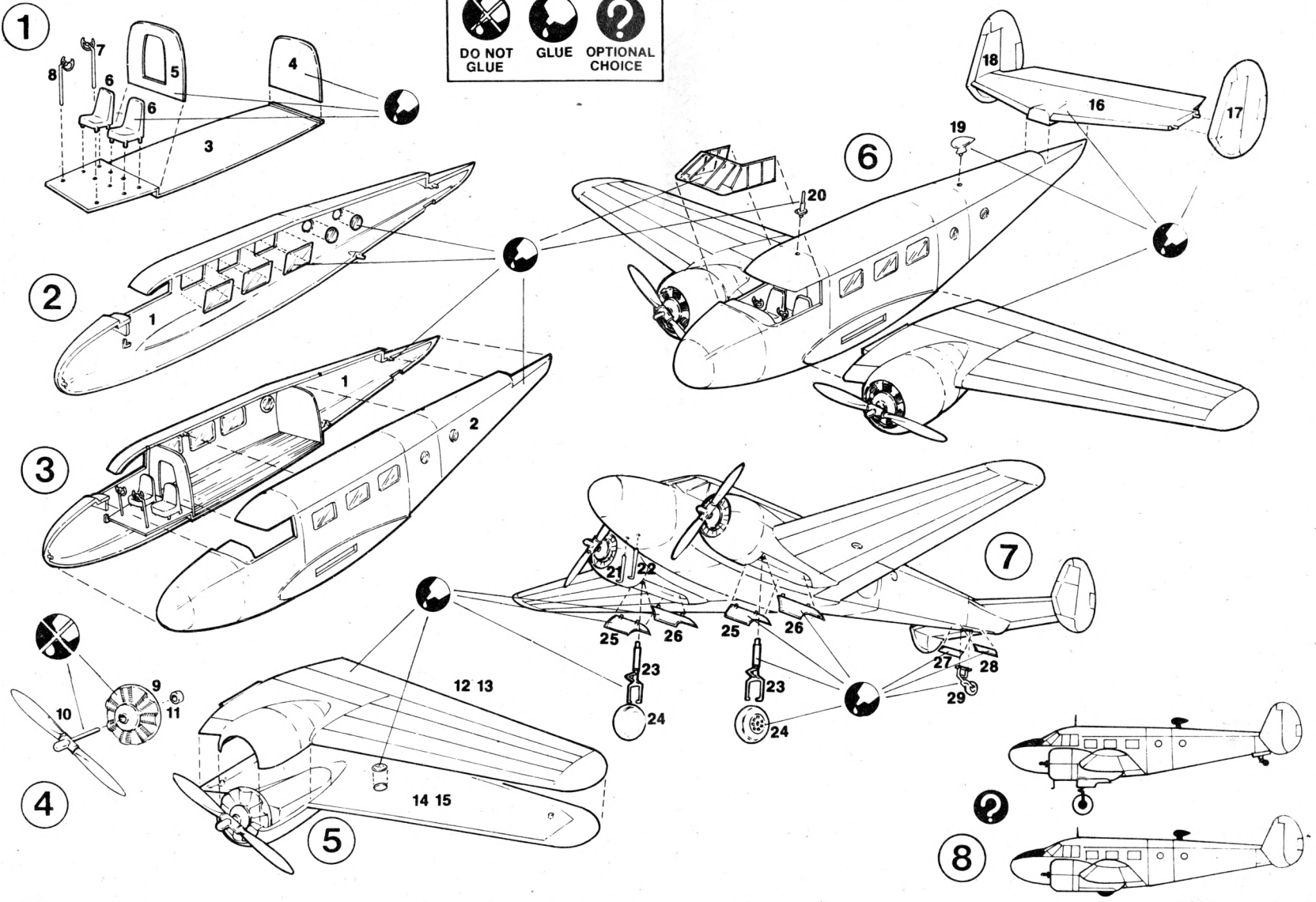



**PIONEER 2**  
SERIES 4 4003

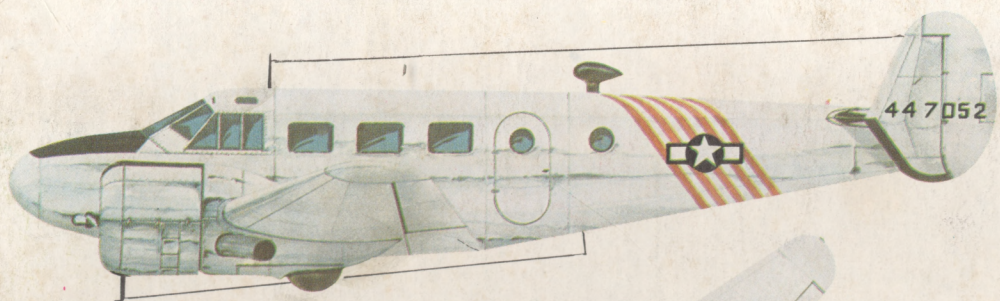

USAAF 1st. AIR COMMANDO  
GROUP CALCUTA-INDIA-1945

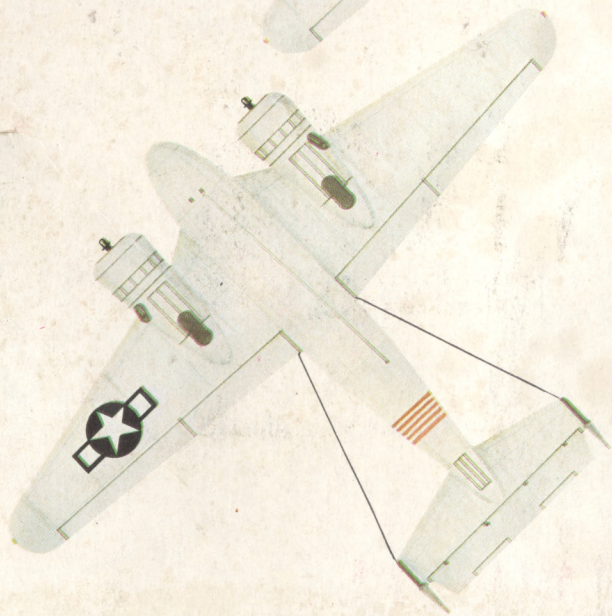

JAPANESE MARITIME  
SELF-DEFENCE FORCE-1956

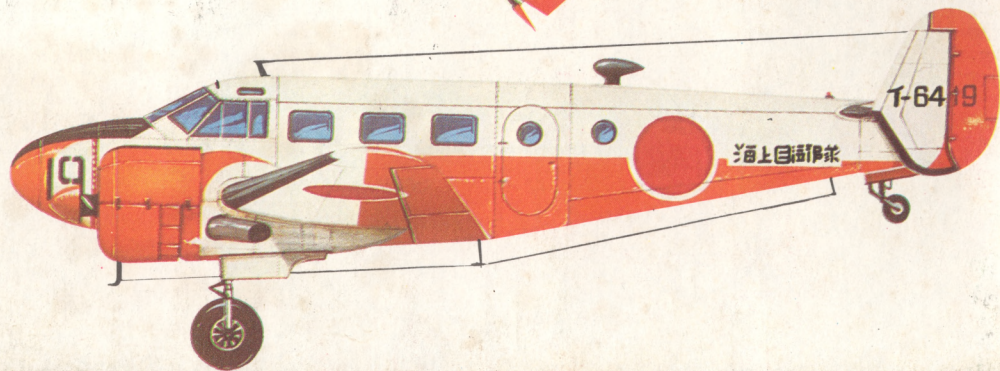



1-6419

19

海上自衛隊

1-6419

19

海上自衛隊

5MRRM0000

5R00WJJA



5MRRM0000

5R00WJJA



447 052

447 052